

Sanitary expertise
& water friendly

SIAMP





A SPECIALIST AT YOUR SERVICE FOR 70 YEARS.

Founded in 1947, SIAMP designs and manufactures innovative sanitary products for the bathroom environment, whether it's a commercial project or the renovation of a domestic bathroom, SIAMP has the solution.

Recognised by leading ceramic manufacturers throughout the world, SIAMP is the brand selected to equip their cisterns for the new market.

SIAMP began manufacturing toilet seats in Monaco, today with 5 production plants around the world, we produce a substantial range of sanitary equipment including, toilet seats, flushing mechanisms, inlet valves, WC wall frames, concealed cisterns and much more.

Through 8 subsidiaries and hundreds of valued distributors we are able to make our wide range of products available, globally, to millions of consumers.

To remain a sanitary specialist in this evolving market, we invest in new technologies to develop new products, and perfect the efficiency of manufacturing.

Our aim is to meet the expectations of the consumer with high quality, innovative, eco-efficient solutions that guarantee hygiene, comfort and responsible management of water.

Understanding the importance of water sustainability, SIAMP continue to develop technical solutions to protect this resource for future generations.

SIAMP is regularly at the origin of innovations recognised by a large number of international patents.



OUR SOLUTIONS

SIAMP innovations provide solutions and technological advantages to these important areas

- **Water saving**
- **Easy installation**
- **Acoustic comfort**
- **Hygiene**
- **Solutions for less abled**



QUALITY

Our approach to quality starts at the design stage and is followed through the manufacturing and distribution process.

All SIAMP products are subjected to rigorous and intense tests, using our own, and third party test laboratories. We regularly test our products in extreme conditions.

Our WC wall frames are subjected to loads of 400kg and our flushing systems to 200,000 repetitive performance and endurance tests.

WC wall frames, concealed cisterns and flushing systems are guaranteed for 10 years.



CERTIFICATION

All our products are designed and developed in order to meet the most demanding UK and international standards, along with voluntary certification schemes.

We are committed to manufacturing high quality products and employing best practices, in order to guarantee constant quality levels and product performance.

Our flushing solutions are WRAS approved.

Our cisterns are compliant with  EN 14055

Our WC packs are compliant with  EN 997 Type 2 &  EN 14055 Type 2



CUSTOMER SERVICE / SPARE PARTS

We pride ourselves on providing outstanding customer service, including presale technical advice and ongoing support throughout the lifecycle of the product.

Furthermore all spare parts are available from our Manchester based distribution centre.



INNOVATION

Serving our customers with innovation has been a driving force of SIAMP for 70 years.

SIAMP is the origin of many innovations in the world of toilets and puts all its resource into designing and manufacturing innovative and eco-efficient solutions that guarantee hygiene, comfort and responsible management of water.

These innovations are the subject of technical patents all over the world.



SUSTAINABILITY

SIAMP adopts an environmental approach that is implemented in all areas from design to distribution.

This approach includes, in particular, the sustainability requirements of our products but also the development of solutions and systems that promote water saving.

SUPPORTING WATER EFFICIENCY

Understanding the importance of water sustainability, SIAMP continue to develop technical solutions to protect this resource for future generations.

We are proud to support the following water saving initiatives.

WATER LABEL

The European Water Label is a voluntary scheme adopted by manufacturers to promote the water efficiency of their products. The scheme enables customers, to easily compare the amount of water different products use and make informed decisions that will save them water and money. Throughout the brochure we use the below labels to indicate the water efficiency of our products as outlined by the scheme.

www.europeanwaterlabel.eu

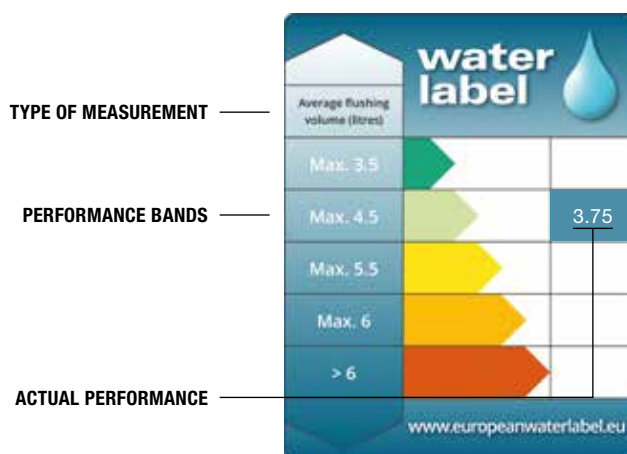

BREEAM

BREEAM is an international scheme that provides independent third party certification for the assessment of the sustainability performance of individual buildings, communities and infrastructure projects.

BREEAM WAT 01 Water consumption - assessment aims to reduce the consumption of potable water for sanitary use in new buildings from all sources through the use of water efficient components and water recycling systems.

www.breeam.org

PART G

Approved Document G of The Buildings Regulation outlines the requirement for water efficiency of new dwellings. The potential consumption of wholesome water must not exceed more than 125 litres per person per day.

WRAS

WRAS contributes to the protection of public health by preventing contamination of public water supplies and encouraging the efficient use of water by promoting and facilitating compliance with the Water Supply (Water Fittings) Regulations and Byelaws in Scotland. Products approved by the scheme are deemed to comply with the requirements of the Water Supply (Water Fittings) Regulations 1999 and amendments.



Throughout the brochure we use the WRAS logo to indicate products which are WRAS approved.

Visit www.wras.co.uk/directory and search for SIAMP to access the full listing.



INTERNATIONAL PRESENCE

In addition to its headquarters and a factory based in Monaco, SIAMP is present throughout Europe and worldwide.

Our products are present today on 5 continents through 8 subsidiaries, 5 production plants and hundreds of distributors for the benefit of millions of users. Our goal is to be closer to our customers and users to support them in their development and projects.

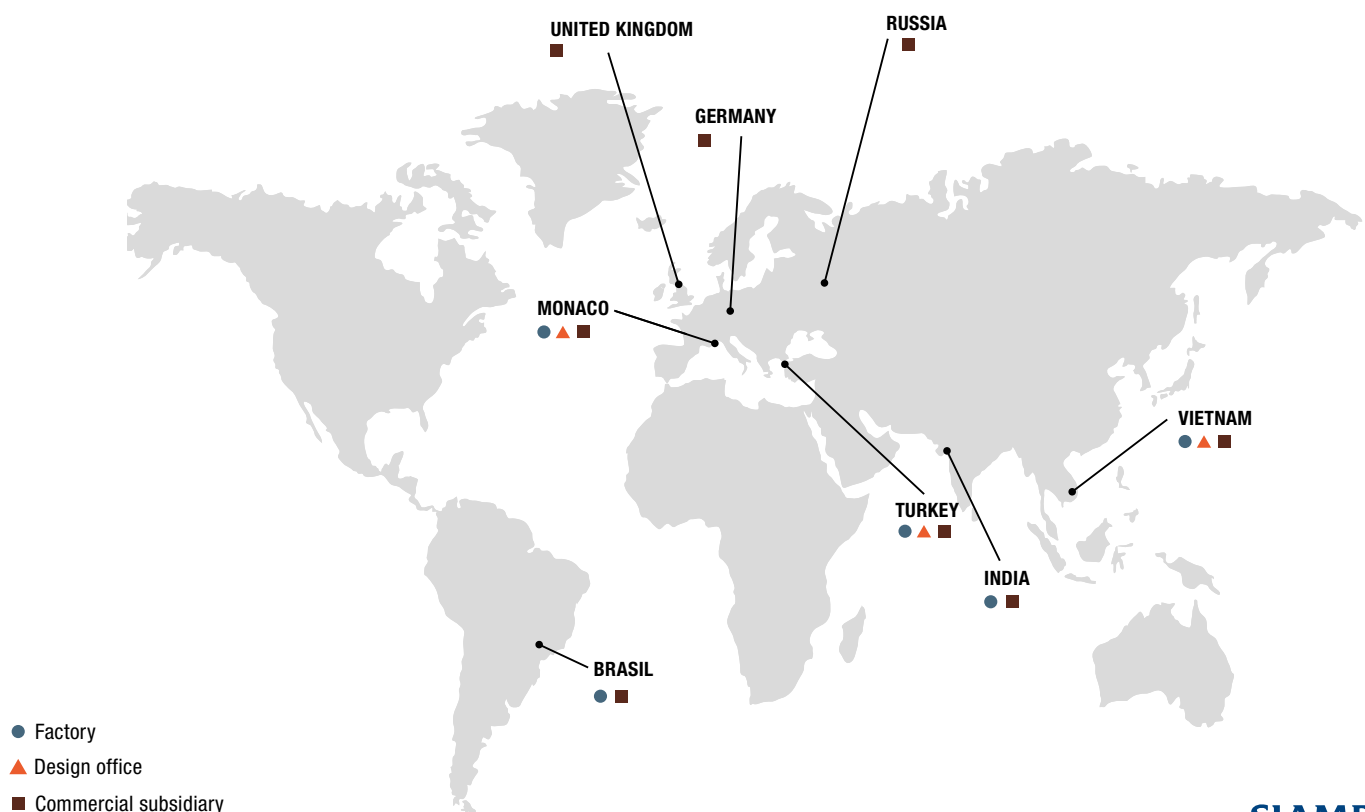

INGENIO

Wall hung wc frame solution developed FOR THE PROFESSIONAL INSTALLER

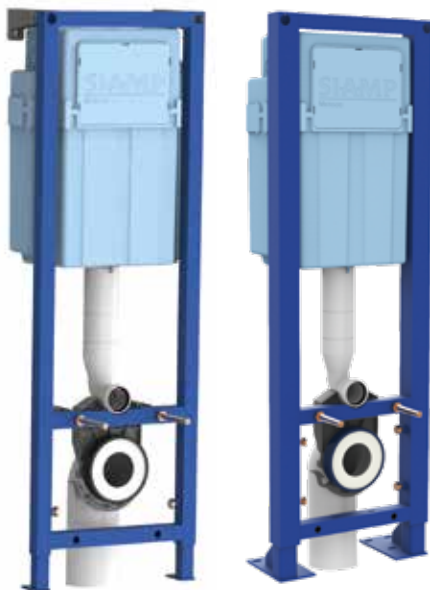

See p.19

SPHERE

Round design with soft edges

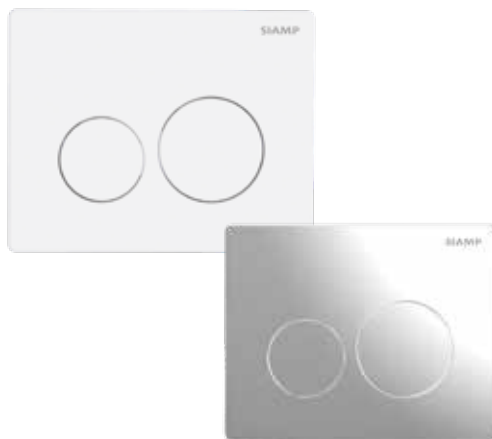

See p.45

BCM INTRASLIM

This popular cistern is now available as a wall frame.



See p.21

COMPACT 100 DELAYED ACTION



See p.55

TOILET SEATS

See p. 66-69



Azur Premium Slim



Vence Premium



Mougins Classic



PMR



WALL FRAMES INTRODUCTION

p . 8 / 11

WALL FRAME SOLUTIONS

p . 12 / 23

WC Frames INGENIO	p. 19
Tall WC Frames	p. 20
Low Height WC Frames	p. 21
Basin Frame	p. 22
WC / Bidet Frame	p. 23

WC PACKS

p . 24 / 27

Deluxe Samoa	p. 26
Standard Samoa	p. 27



WALL FRAME ACCESSORIES

p . 28 / 33

CONCEALED CISTERNS

p . 34 / 41

Mechanical	p. 37
Cable	p. 37
Pneumatic	p. 39
Concealed Cistern Accessories	p. 40



FLUSH PLATES

p . 42 / 51

Flush Plates - Inspiration	p. 45
Flush Plates - Essential	p. 50
Flush Plates - Commercial	p. 51

TECHNICAL EQUIPMENT

p . 52 / 66

Inlet Valves	p. 55
Flush Valves	p. 59
Component packs	p. 62
Accessories & spare parts	p. 63

TOILET SEAT

p . 64 / 73

Thermoset	p. 68
Thermoplastic	p. 71
MDF	p. 72
Composite Wood	p. 72



WALL FRAMES INTRODUCTION

Wall frames make it possible to install wall hung sanitaryware, safely and easily.

WALL FRAME SOLUTIONS

WC Frames INGENIO p. 19

Tall WC Frames p. 20

Low Height WC Frames p.21

Basin Frame p. 22

WC / Bidet Frame p. 23

WC PACKS

Deluxe Samoa p. 26

Standard Samoa p. 27

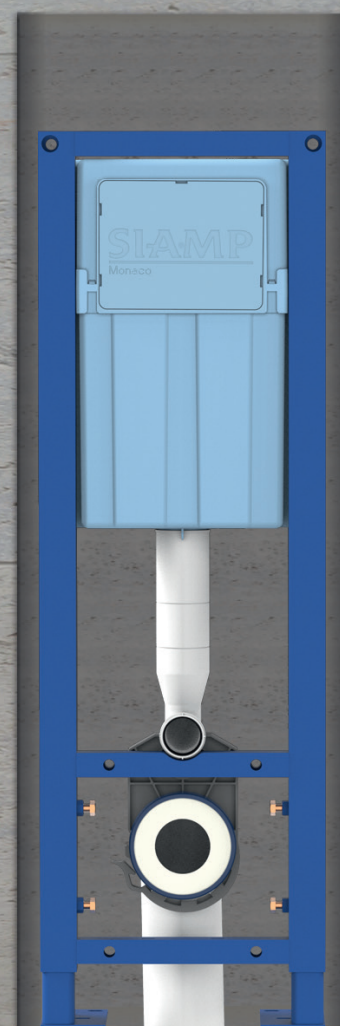

WALL FRAMES INTRODUCTION

ROBUST



Our WC wall frames are tested to withstand a load of 400kg





Our washbasin wall frames are tested to withstand a load of 150kg



DESIGN

A wide range of decorative flush plates, with designs and finishes to suit any bathroom



SPECIALIST

As a flushing expert, our cisterns are equipped with our own range of flush and inlet valves.

All our solutions are endurance tested to 200,000 cycles for assured reliability, meeting the most demanding worldwide certifications.



WATER SAVING

Our WC frames include delayed action inlet valves*.

The dual flush volume is pre-set at 6/4 litres and can be easily adjusted on site to 4/2.6 litres when used with a compatible wall hung pan.



*With exception of BCM Intrasilim

100% TESTED

Every cistern is tested for leaks during the production process. The cisterns are insulated to reduce the risk of condensation and also help reduce noise.

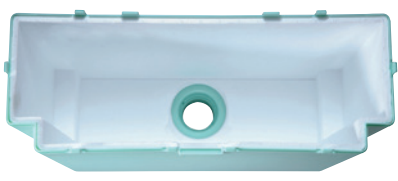

MAINTENANCE

The flush plate serves as the access point for easy maintenance.

Spare parts are readily available.

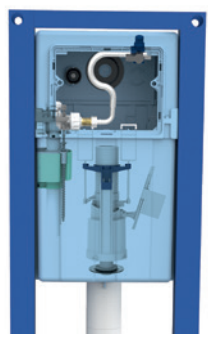

CORNER SOLUTION

We offer solutions for corner installation, or installation on an angle.

Two possible installations with the optional corner installation kit.

- 90° corner installation
- up to 30° angle on a single wall



LOW HEIGHT SOLUTIONS



Ideal for under windows, in cloakrooms or low height tiled solutions in conjunction with a semi-recessed or wall mounted basin.

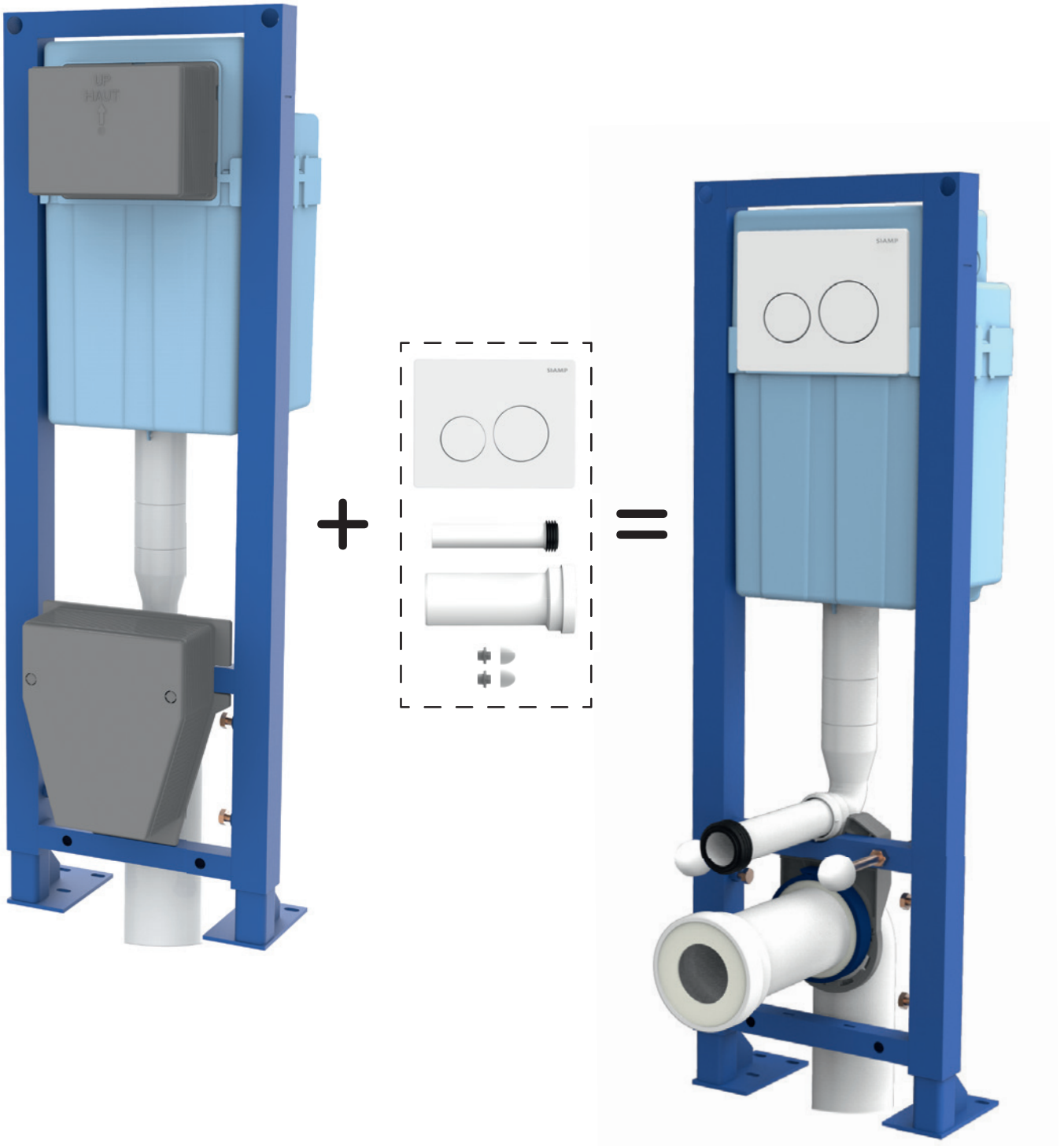

THE WALL FRAME FOR COMMERCIAL PROJECTS

INGENIO



WALL FRAMES	INGENIO wall fixing	INGENIO self-supporting	BCM 350	BCU 350	BCM INTRASLIM	BCM 790	BCM 800	SCU 350	BLM 400
WALL FRAME TYPE									
Wall frame with concealed cistern	•	•	•	•	•	•	•		
WC frame only								•	
Washbasin									•
Bidet								•	
CAN BE INSTALLED ON...									
Self-supporting (solid floor)		•		•				•	
Load bearing wall	•	•	•	•	•	•	•	•	•
DIMENSIONS									
Reduced width	•	•	•	•				•	•
Reduced height						•	•	•	
FLUSH PLATE TYPE									
Front	•	•	•	•	•	•			
Top							•		
COMFORT									
Quieto delayed action	•	•							
GUARANTEE (YEARS)	10	10	10	10	10	10	10	10	10
	•	•	•	•	•	•	•		
			•	•		•			

WALL FRAME SOLUTIONS

WC FRAMES

SIAMP offers a wide range of wall frames that can safely support wall hung WCs.

INGENIO

Complete with fast fix solutions INGENIO makes for a simple installation.

TALL WALL FRAMES

BCM350 and BCU350 are tall and narrow, offering a compact installation and great resistance.

BCM INTRASLIM can fit in a cavity of only 123mm for narrow depth installation.

LOW HEIGHT FRAMES

Suitable for installation below windows, in cloakrooms or low height tiled solutions in conjunction with a semi-recessed or wall mounted basin.

The BCM 790 features a front flush plate and the BCM 800 has a top flush plate

WASHBASIN AND BIDET FRAMES:

The BLM400 allows support for a wall hung washbasin. When combined with a wall hung WC, it helps create modern bathroom styling.

The SCU350 supports either a wall hung bidet or can be used with a wall hung WC, in conjunction with a concealed cistern.

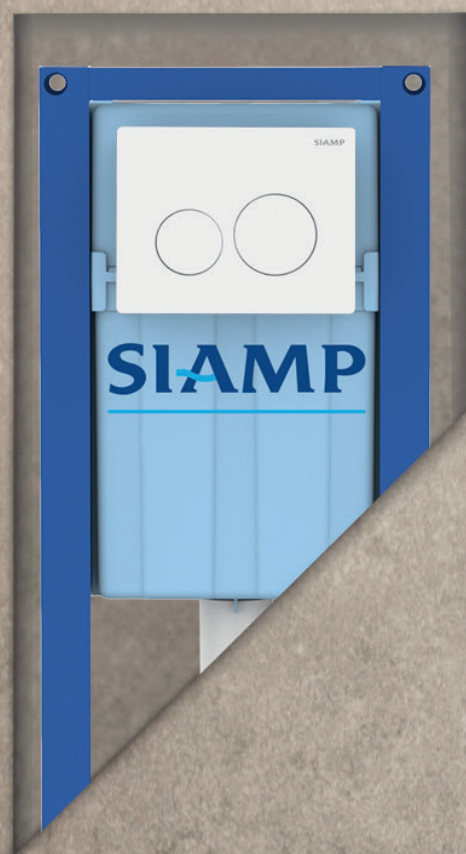

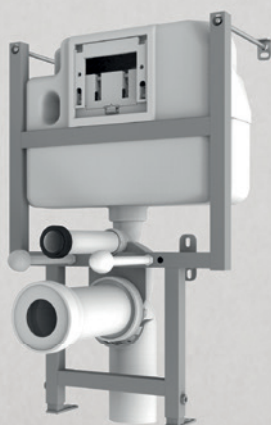
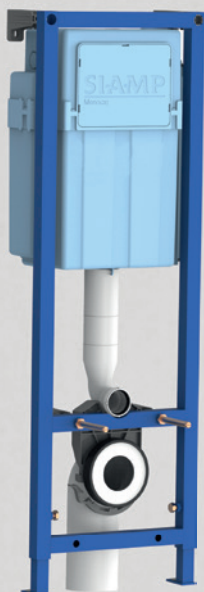

WC FRAMES INGENIO

p . 19 / 21



INGENIO WALL FIXING

p. 19



INGENIO SELF-SUPPORTING

p. 19

TALL WC FRAMES

p . 20 / 21



BCM 350

p. 20



BCU 350

p. 20



BCM INTRASLIM

p. 21

LOW HEIGHT WC FRAMES

p . 21 / 22



BCM 790

p. 21



BCM 800

p. 22

BASIN FRAME

p . 22



BLM 400

p. 22

WC / BIDET FRAME

p . 23



SCU 350 WC/BIDET FRAME

p. 23

Wall hung WC frame solution developed
FOR THE PROFESSIONAL INSTALLER

WALL FRAMES

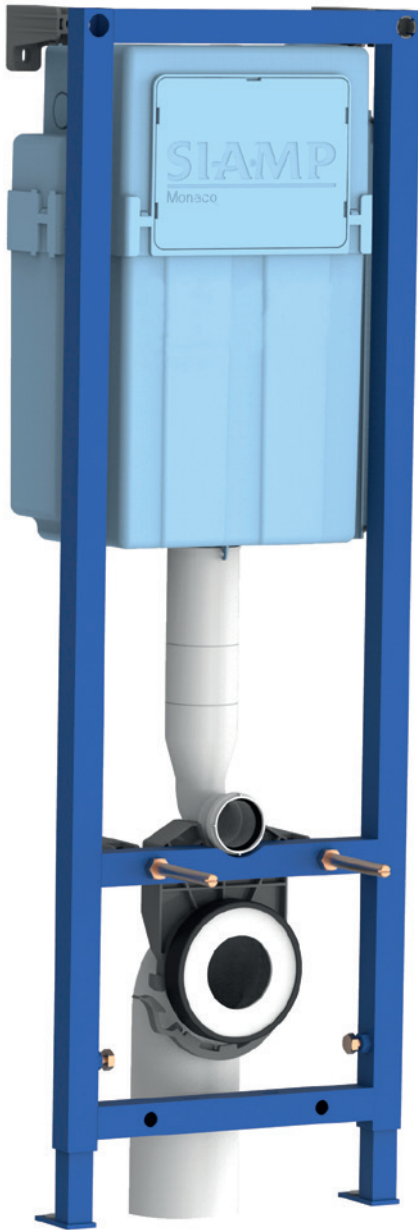

Specify and install with the confidence of a 10 year guarantee



Fast, precise, easy installation



Ultra quiet, and water saving. QUIETO delayed action inlet valve with acoustic levels of only 9dB



Compliant with EN14055 Type 2



INGENIO Load bearing to 400kg.

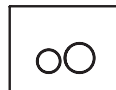

Large choice of elegant and stylish flush plates

INGENIO DOCUMENTATION



Brochure INGENIO

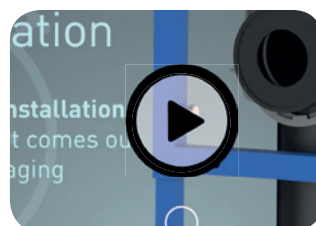

Video INGENIO



NEW WC FRAME

INGENIO

WALL FIXING

Wall fixing structure transfers the force applied to the WC bowl through a load bearing wall. The unique wall fixation at the WC bowl level offers greater force transfer and higher resistance.

Narrow frame makes in perfect for compact installations and greater resistance.

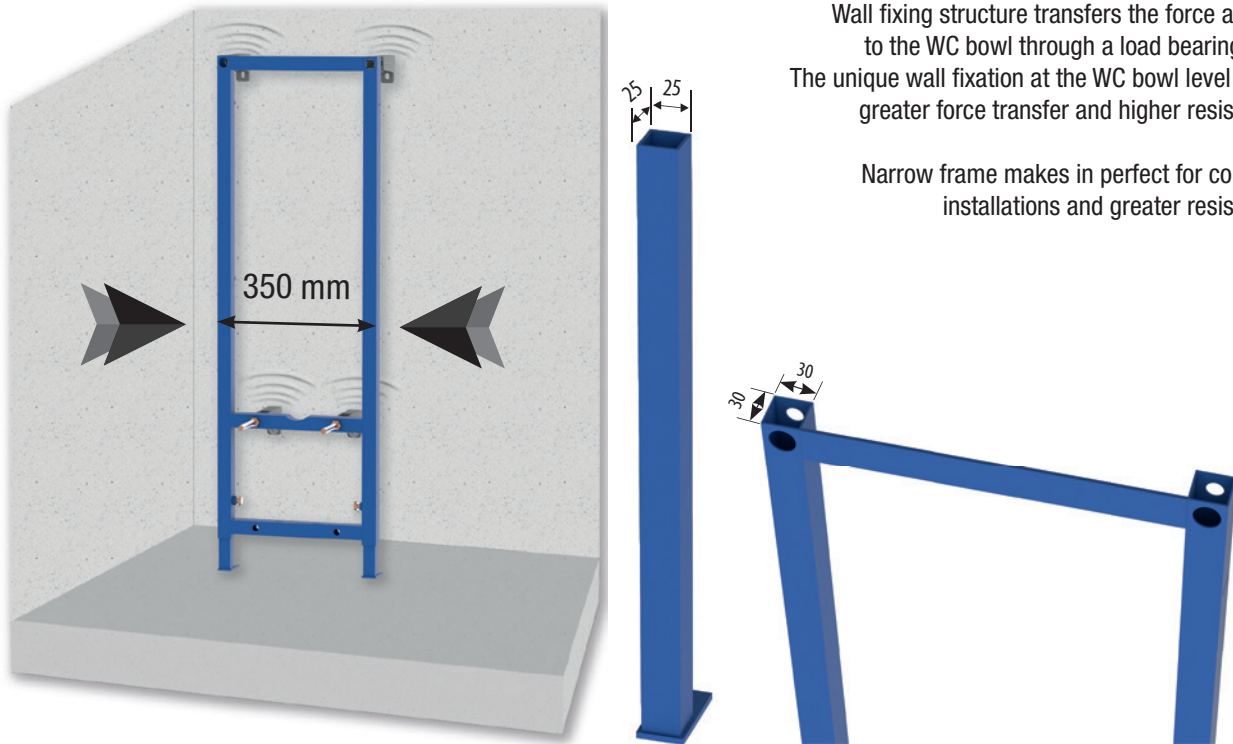

SELF SUPPORTING

Self supporting structure transfers the force applied to the WC bowl through the supporting floor.

Narrow frame makes in perfect for compact installations and greater resistance.

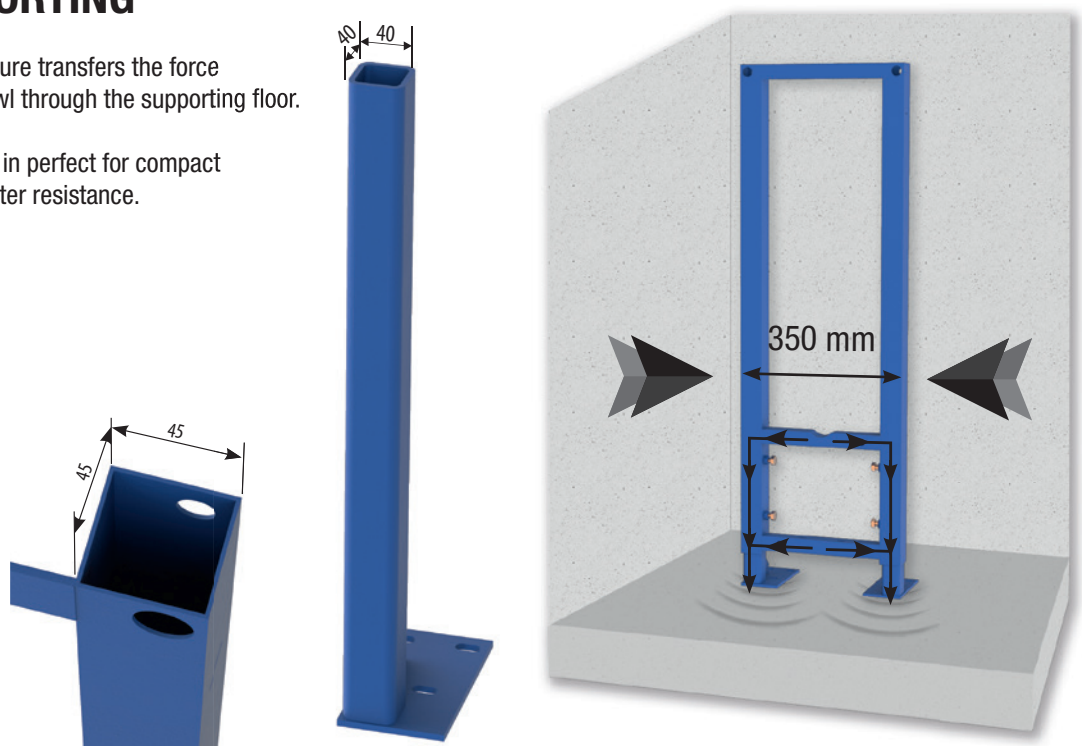

PRODUCT FEATURES INGENIO

ULTRA QUIET

The first WC wall frame equipped with an ultra quiet inlet valve, acoustic levels of only 9 dB.

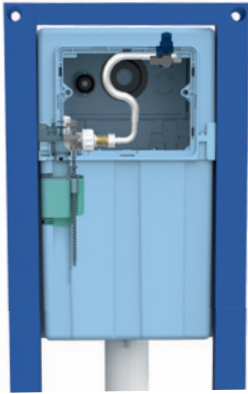

WATER SAVING

The box that surrounds the float of Quieto has 2 functions:

- the first is to delay the inlet valve from re-filling the cistern until the flush valve has closed. Saving water from being wasted during the flushing cycle.

- the second is to maintain a consistent volume of water entering the cistern. As the cistern refills with speed, the water spills over into the box, rapidly lifting the float for a quick reliable shut off.

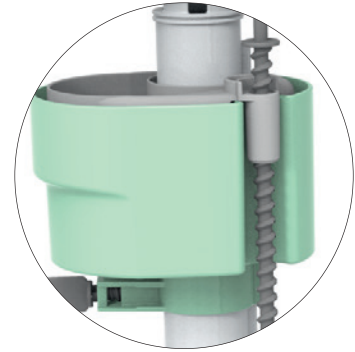

SECURE

The connection of the inlet valve to the water supply is made inside the cistern. A specially designed curved hose with built-in isolation valve means there is only a single connection to the water supply, reducing the number of joints where a leak could take place.

In the most unlikely event a leak occurs from this connection it will be contained within the cistern, the water will pass through the internal offering double security against leaks.

The connection of the hose to the inlet valve is done by means of a flat seal and an o-ring which sits internally of the tail, offering a double seal for further leak prevention.

Secure installation:
Built-in isolation valve

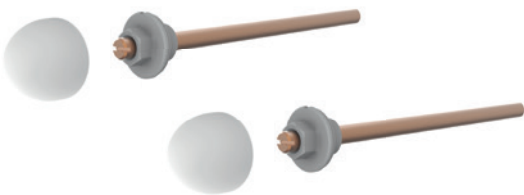
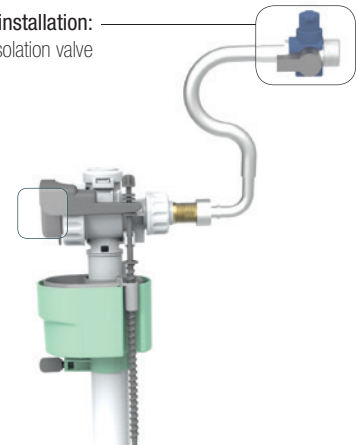

INSTALLATION WITHOUT EFFORT

Our new 3 in 1 nut allows the WC to be fastened with one single fixing, reducing the time and effort taken when compared to a traditional fixing with separate washers & nuts.

INSTALLATION READY

Height and depth adjustments are made simple with our fast fix solutions, ready for first fix installation in an instant.

- feet are supplied in the installation position
- self-braking vertical adjustment for precise height setting
- built-in bullseye spirit level
- Snap & click, fast fixing mounting rods

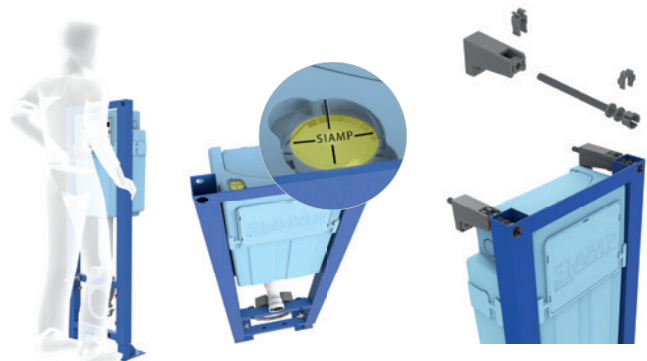

VERSATILE WATER CONNECTION

Water connection can be made either from the left or right.

The curved hose provides flexibility in the event the water supply pipe is made too long or too short, the isolation valve can be detached from its fixed position to make the connection.

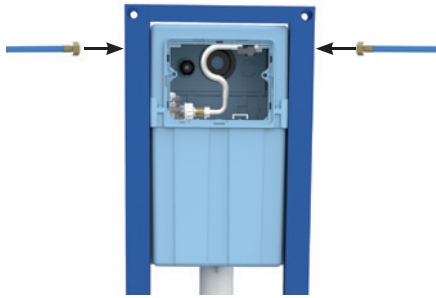

MAXIMUM SITE PROTECTION

The cistern is protected against intrusion of foreign bodies by offering only few openings. The crucial openings are protected during the first and second fix stages by rigid protection shrouds

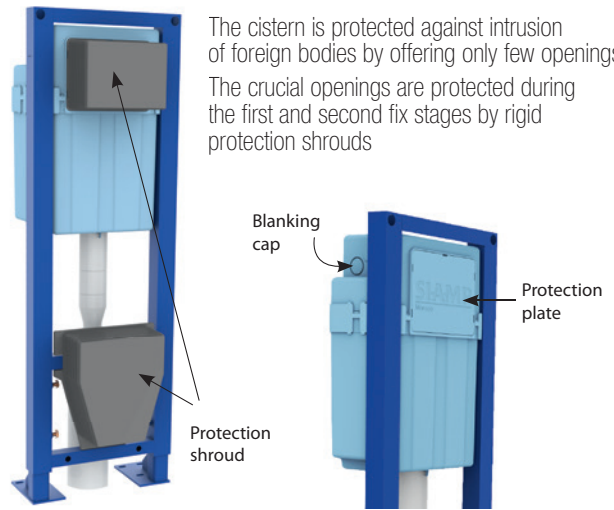

FAST, PRECISE INSTALLATION

Lettered guidance = **Simple adjustment** of the fixation rods

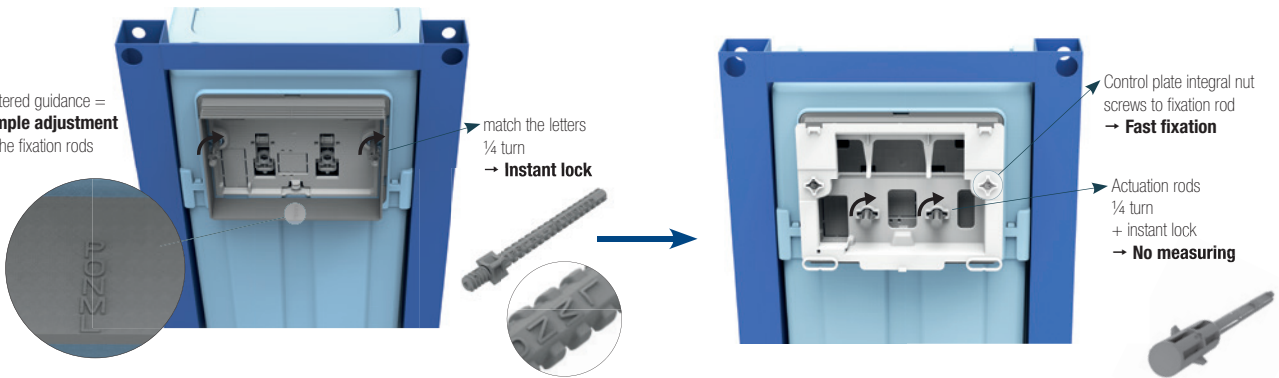

WATER CONTROL

The built-in isolation valve is accessible by removing only the flush plate. Time saving when connecting or isolating the water supply.

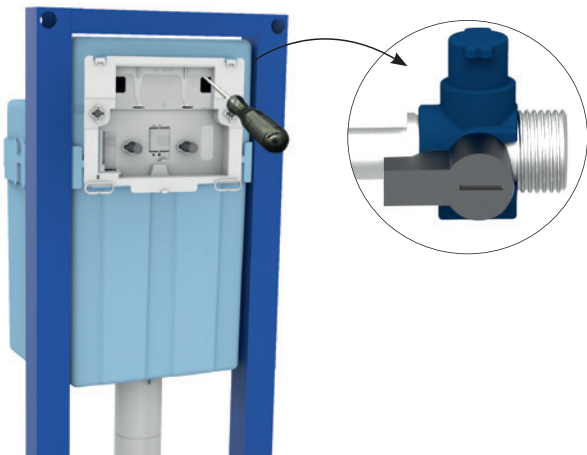

EASY MAINTENANCE

Once installed **INGENIO** is easy to maintain. No tools required. Access to all internal components is made through the wide opening behind the flush plate or through the rear access panel.



Both the flush valve and inlet valve can be removed from the cistern independently of each other.

Spare diaphragm and flush valve seal supplied

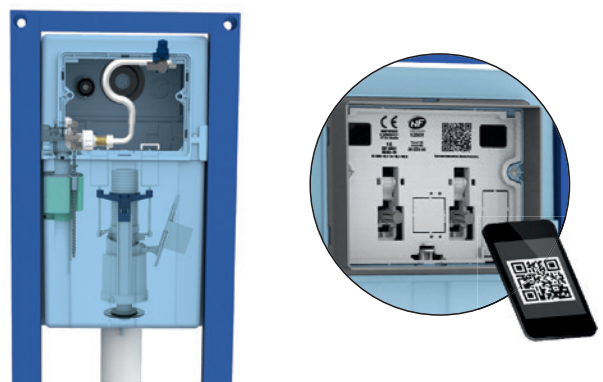
QR code provides immediate access to the user's manual.



QUICK REFERENCE MATRIX

WALL FRAMES		INGENIO Wall Fixing	INGENIO Self-Supporting	BCM 790	BCM 800	BCM INTRASLIM	BCM 350	BCU 350	BLM 400	SCU 350
Fixing type	Supporting floor		•					•		•
	Supporting wall	•	•	•	•	•	•	•	•	•
Dimensions	Width (mm)	350	350	502	400	572	350	350*	400	350
	Height (mm)	1100 ~ 1300	1100 ~ 1300	790 ~ 990	800 ~ 1000	1100 ~ 1300	1100 ~ 1300	1100 ~ 1300	1100 ~ 1300	508 ~ 550
	Depth (mm)	145 ~ 240	145 ~ 240	150 ~ 245	180 ~ 245	123 ~ 250	142 ~ 245	Self-supporting 142**	80 ~ 245	140
	WC height fixing range (mm)	325 ~ 525	325 ~ 525	325 ~ 525	325 ~ 525	325 ~ 525	325 ~ 525			
	WC fixing centers (mm)	180	180	180 / 230	180 / 230	180 / 230	180 / 230	180 / 230	180 / 230	-
Flush plate type	Front	Ingenio Sphère Ingenio Album 360, Ingenio Album 90, Ingenio Reflet 360, Ingenio Reflet 90, Ingenio Square, Ingenio Segment, Ingenio Smart, Ingenio Smarty		Album 360, Album 90, Reflet 360, Reflet 90, Square, Segment, Smart, Smarty, Lemon, Ying Yang , Monovolume anti-vandal		Album 360, Album 90, Reflet 360, Reflet 90, Square, Segment, Smart, Smarty, Ying Yang, Lemon, Smart Infrared, Monovolume anti-vandal		-	-	
	Top				BCM 800				-	-
Miscellaneous	Can be adapted to less-able use	•	•	•	•	•	•	•	-	•
	Water saving and Delayed Action	•	•	•	•		•	•	-	-
	WC pack option	•							-	-
Guarantee (years)	10	10	10	10	10	10	10	10	10	10
 EN 14055 Type 2	•	•	•	•	•	•	•	•	-	-
			•				•	•		

*Total width at the feet base: 385 mm

** For horizontal evacuation and 147 mm for vertical evacuation

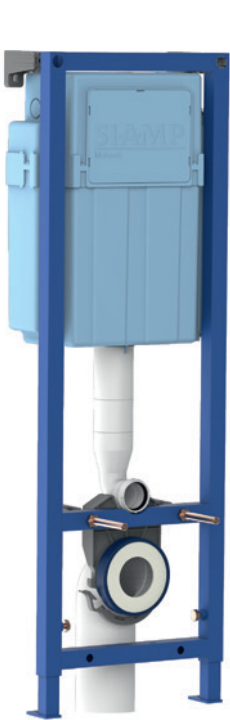

INGENIO WALL FIXING

Designed for the professional installer

Fast installation

- Wall fixing structure load bearing to 400kg
- Feet delivered in the installation position
- Self-braking vertical adjustment for precise height setting
- Snap & click, wall mounting rods
- 6/4 litre dual flush, on site adjustable to 4/2.6 litre
- QUIETO delayed action ultra quiet inlet valve
- Mechanical flushing
- Insulated cistern with protection against foreign bodies
- Secure water connection inside the cistern, built-in isolation valve accessible through flush plate.
- WC connection kit supplied separately ready for the second fix

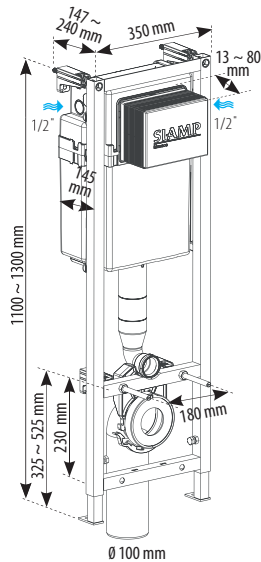

	Ref.	Barcode	Packing	Packing Nb	Packing Kg	Pallet quantity
INGENIO WALL FIXING	10 0022 33	3 24723 013482 3	Carton	1	14	28
INGENIO WC CONNECTION KIT	34 1171 67	3 24723 009946 7	Bag	1	-	-

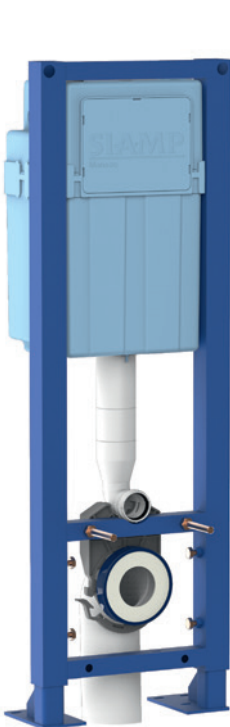

INGENIO SELF-SUPPORTING

Designed for the professional installer

Fast installation

- Self-supporting structure load bearing to 400kg
- Feet delivered in the installation position
- Self-braking vertical adjustment for precise height setting
- 6/4 litre dual flush, on site adjustable to 4/2.6 litre
- QUIETO delayed action ultra quiet inlet valve
- Mechanical flushing
- Insulated cistern with protection against foreign bodies
- Secure water connection inside the cistern, built-in isolation valve accessible through flush plate.
- WC connection kit supplied separately ready for the second fix

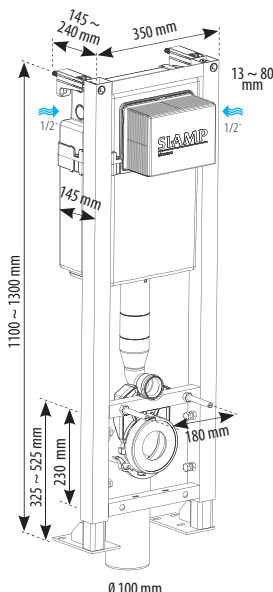

	Ref.	Barcode	Packing	Packing Nb	Packing Kg	Pallet quantity
INGENIO SELF-SUPPORTING	10 0022 34	3 24723 013483 0	Carton	1	17.6	28
INGENIO WC CONNECTION KIT	34 1171 67	3 24723 009946 7	Bag	1	-	-

TALL WC FRAMES

WALL FRAMES

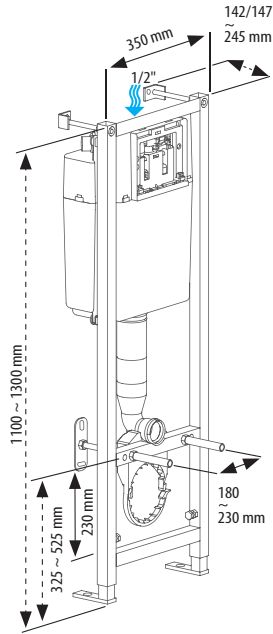

BCM 350 Tall & compact

- Wall fixing structure load bearing to 400kg
- 6/4 litre dual flush, onsite adjustable to 4/2.6 litre
- **Delayed action filling**
- **WRAS approved 95L inlet valve**
- Mechanical flushing
- 1/2" brass isolation valve
- Insulated to prevent condensation
- **Access for maintenance through the flush plate**
- Includes 90° drain connection kit

	Ref.	Barcode	Packing	Packing Nb	Packing Kg	Pallet quantity
BCM 350	31 2315 13	3 24723 002022 5	Carton	1	15.1	28

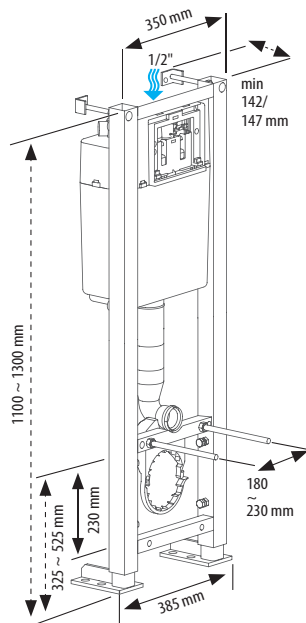

BCU 350 Self-supporting tall & compact

- **Self-supporting structure load bearing to 400kg**
- 6/4 litre dual flush, on site adjustable to 4/2.6 litre
- **Delayed action filling**
- **WRAS approved 95L inlet valve**
- Mechanical flushing
- 1/2" brass isolation valve
- Insulated to prevent condensation
- **Access for maintenance through the flush plate**
- Includes 90° drain connection kit

	Ref.	Barcode	Packing	Packing Nb	Packing Kg	Pallet quantity
BCU 350	31 2104 10	3 24723 009408 0	Carton	1	19.86	28

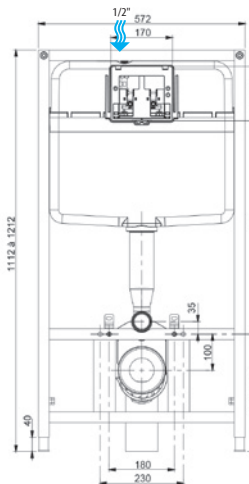

BCM INTRASLIM

Slim for narrow depth installation

- Wall fixing structure load bearing to 400kg
- 6/4 litre dual flush, on site adjustable to 4.5/3 litre
- WRAS approved 95L inlet valve
- Mechanical flushing
- 1/2" brass isolation valve
- Insulated cistern
- Access for maintenance through the flush plate
- Includes 90° drain connection kit

	Ref.	Barcode	Packing	Packing Nb	Packing Kg	Pallet quantity
BCM INTRASLIM	10 0024 53	3 24723 013484 7	Carton	1	16	20

LOW HEIGHT WC FRAMES

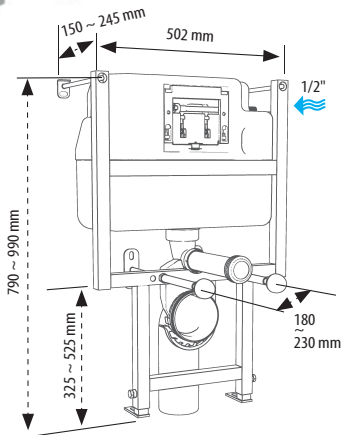
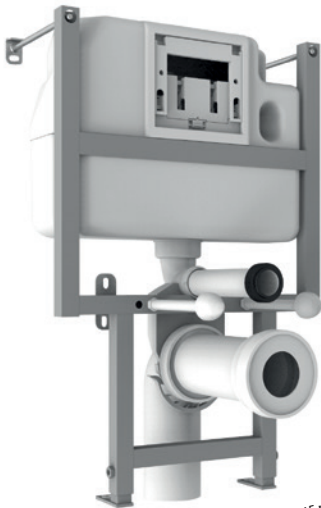

BCM 790

The low height solution

Ideal for below windows & cloakrooms

- Wall fixing structure load bearing to 400kg
- 6/4 litre dual flush, on site adjustable to 4/2.6 litre
- Delayed action filling
- WRAS approved 95L inlet valve
- Mechanical flushing
- 1/2" brass isolation valve
- Insulated to prevent condensation
- Access for maintenance through the flush plate
- Includes 90° drain connection kit

	Ref.	Barcode	Packing	Packing Nb	Packing Kg	Pallet quantity
BCM 790	31 2790 10	3 24723 009132 4	Carton	1	11.5	24

LOW HEIGHT WC FRAMES

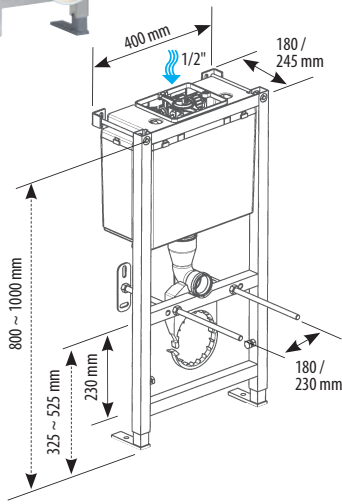

BCM 800

Low height top flush

- Wall fixing structure load bearing to 400kg
- 6/4 litre dual flush, on site adjustable to 4/2.6 litre
- **Delayed action filling**
- **WRAS approved 95L delayed action inlet valve**
- Mechanical flushing
- 1/2" brass isolation valve
- Insulated to prevent condensation
- **Access for maintenance through the flush plate**
- Includes 90° drain connection kit
- **Includes bright chrome top flush plate**

	Ref.	Barcode	Packing	Packing Nb	Packing Kg	Pallet quantity
BCM 800	31 1167 10	3 24723 002371 4	Carton	1	13.35	24

BASIN WC FRAME

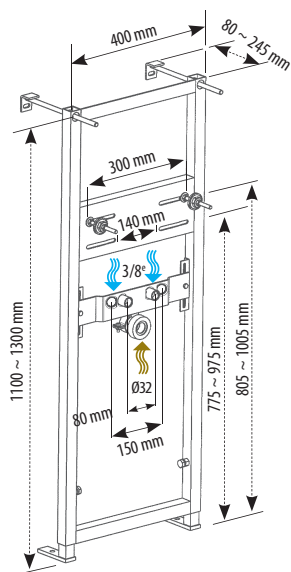

BLM 400

- Wall fixing structure load bearing to 150kg
- Washbasin height adjustment
- Variable distance for fixing bolts
- Water supply connections included

	Ref.	Barcode	Packing	Packing Nb	Packing Kg	Pallet quantity
BLM 400	31 1250 10	3 24723 001346 3	Carton	1	10	40

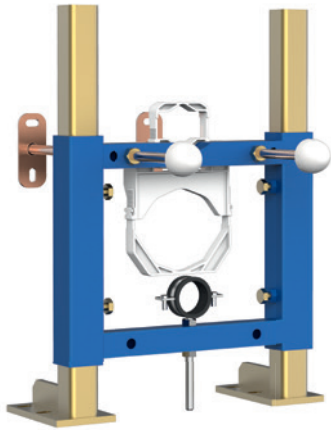

SCU 350 WC / BIDET FRAME

Multipurpose frame

- **Self-supporting structure load bearing to 400kg**
- Accepts flush supply sleeves from Ø30 to Ø50mm
- Accepts WC drain connections from Ø90 to Ø120mm
- Accepts bidet drain connection from Ø38 to Ø45mm

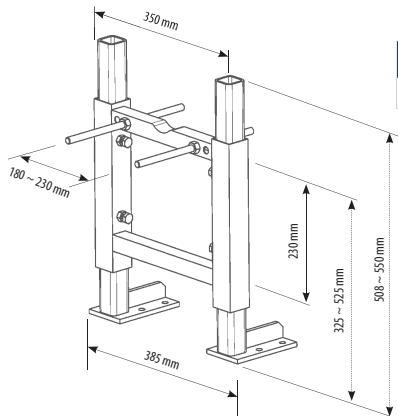

	Ref.	Barcode	Packing	Packing Nb	Packing Kg	Pallet quantity
SCU 350	31 2505 10	3 24723 004670 6	Carton	1	11.45	60

WC PACKS

WC packs are a **one box** solution, comprising of an INGENIO WC frame, WC, flush plate, and toilet seat.

SIAMP has two solutions, with the Deluxe version incorporating a water saving 4 litre flushing WC and QUIETO delayed action inlet valve.



CE
EN 14055
Type 2

CE
EN 997
Type 2

WC PACKS

p . 26 / 27



DELUXE SAMOA

p. 26

STANDARD SAMOA

p. 27

WC PACKS DELUXE

WC PACKS



DELUXE SAMOA PACK

Complete wall hung WC set

Ingenio inside
QUIETO delayed action

- **2 Part wall fixing structure load bearing to 400kg**
- Feet delivered in the installation position
- **Self-braking vertical adjustment for precise height setting**
- Snap & click, wall mounting rods
- 4/2.6 litre dual flush
- **QUIETO delayed action ultra quiet inlet valve**
- Mechanical flushing
- Insulated cistern with protection against foreign bodies
- Secure water connection inside the cistern, built-in isolation valve accessible through flush plate.
- **Sphere chrome flush plate**
- **Rimless wall hung pan**
- **Principaute toilet seat**

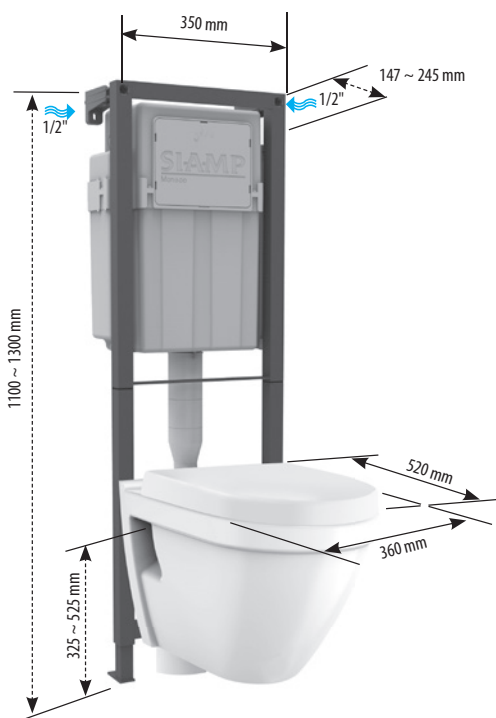

COMPLETE PACK
IN 1 BOX

	Ref.	Barcode	Packing	Packing Nb	Packing Kg	Pallet quantity
WC PACK DELUXE SAMOA	31 2338 10	3 24723 009409 7	Carton	1	42.00	15



Average flushing volume (litres) 3.75

STANDARD SAMOA PACK

Complete wall hung WC set

Ingenio inside

- **2 Part wall fixing structure load bearing to 400kg**
- Feet delivered in the installation position
- **Self-braking vertical adjustment for precise height setting**
- Snap & click, wall mounting rods
- 6/4 litres dual flush
- WRAS approved 95L delayed action inlet valve
- Mechanical flushing
- Insulated cistern with protection against foreign bodies
- Secure water connection inside the cistern, built-in isolation valve accessible through flush plate.
- **Smarty chrome flush plate**
- Standard wall hung pan
- **Mougins toilet seat**

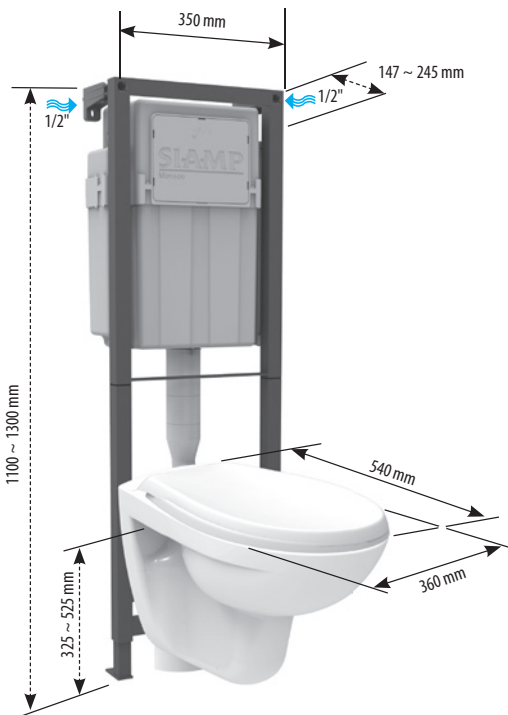

COMPLETE PACK IN 1 BOX

	Ref.	Barcode	Packing	Packing Nb	Packing Kg	Pallet quantity
WC PACK STANDARD SAMOA	31 1858 15	3 24723 004059 9	Carton	1	38.00	15

WALL FRAME ACCESSORIES





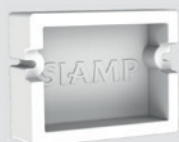







A range of accessories to deal with varying types of WC frame installation.





WALL FRAME ACCESSORIES

p . 30 / 31

	INGENIO WC CONNECTION KIT	p. 30
	BENT DRAIN PIPE	p. 30
	STRAIGHT DRAIN PIPE	p. 30
	PAN CONNECTOR	p. 31
	LONG SUPPLY SLEEVE STRAIGHT CONNECTOR	p. 31
	100-110MM ADAPTER R110	p. 31
	EXTENDED RODS	p. 32
	EXTENDED FIXATION AND ACTUATION SCREWS	p. 32
	PROTECTIVE COVER KIT INGENIO	p. 32
	EXTENDED FLUSH PLATE FIXING SCREWS	p. 33
	M10 TOP CORNER MOUNTING BRACKETS	p. 33
	M12 BOTTOM CORNER MOUNTING BRACKETS	p. 33

WALL FRAME ACCESSORIES



INGENIO WC CONNECTION KIT

- Rigid pan connector length 285mm, made of PVC, EPDM seal
- Flush pipe sleeve length 239 mm, made of HDPE, conical washer
- Fast WC pan mounting kit with nuts and covers

BENT DRAIN PIPE

- 90° Bent drain pipe, made from PVC.
- Solvent weld
- Clamps into wall frames
- EPDM seal

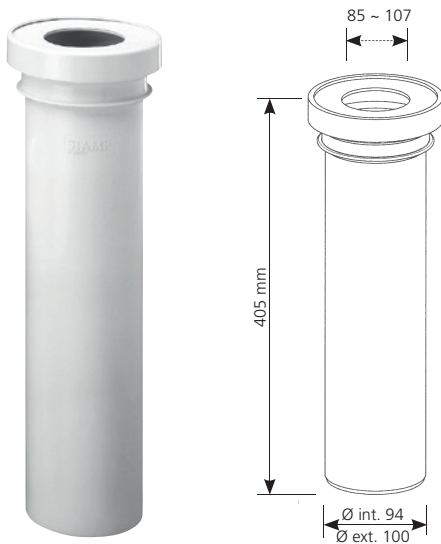
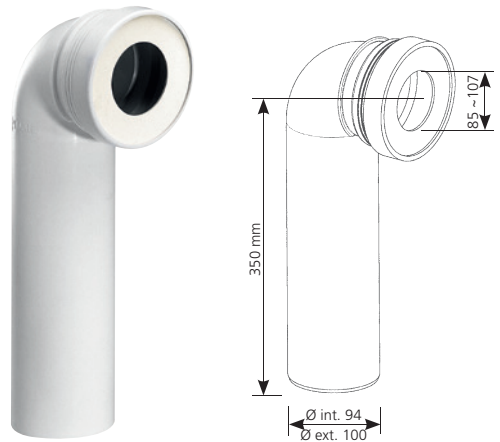

STRAIGHT DRAIN PIPE

- Straight drain pipe, made from PVC.
- Solvent weld
- Clamps into wall frames
- EPDM seal

	Ref.	Barcode	Packing	Packing		Pallet quantity
				Nb	Kg	
INGENIO WC connection kit	34 1171 67	3 24723 009946 7	Bag	1	-	-
Bent drain pipe	92 2003 00	3 24723 009684 8	-	10	-	360
Straight drain pipe	92 3000 07	3 24723 001269 5	-	15	-	240

PAN CONNECTOR

- Rigid pan connector length 190mm, made of PVC.
- EPDM seal

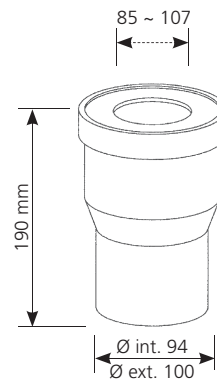

LONG SUPPLY SLEEVE STRAIGHT CONNECTOR

- For use where there is an oversized recess or void between the frame and the outer wall
- Length 450 mm

100-110MM ADAPTER R110

- Connector in between Ø 110 mm female and Ø 100 mm male pipe
- Made from PVC
- Solvent weld

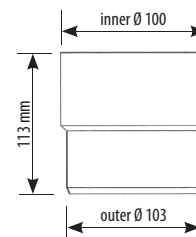

	Ref.	Barcode	Packing	Packing		Pallet quantity
				Nb	Kg	
Pan connector	92 3020 00	3 24723001295 4	-	21	6,28	420
Long supply sleeve straight connector	92 0145 07	-	-	-	-	-
100-110mm adapter R110	92 3060 52	3 24723 009431 8	Bulk	45	-	-

WALL FRAME ACCESSORIES



EXTENDED RODS

- For use where there is an oversized recess or void between the frame and the outer wall
- M12 male, M12 female
- Extension length : 78 mm

EXTENDED FIXATION AND ACTUATION SCREWS for use with INGENIO

- For use with Ingenio
- Extension to be used when void is between 80mm-180mm.



EXTENDED FIXATION AND ACTUATION SCREWS for use with INGENIO (Album/Reflet only)

- For use with Ingenio
- Extension to be used when cladding void is between 80mm-180mm.



PROTECTIVE COVER KIT INGENIO

- For use with Ingenio
- Protects against intrusion of debris
- To be used when void is between 80mm-180mm.



	Ref.	Barcode	Packing	Packing		Pallet quantity
				Nb	Kg	
M12 Extended rods	34 1151 07	3 24723 001962 5	Bag	2	-	-
Extended fixation and actuation screws for use with INGENIO	10 0021 80	3 24723 013393 2	Bag	1	-	-
Extended fixation and actuation screws for use with INGENIO (Album / Reflet only)	10 0021 84	3 24723 013394 9	Bag	1	-	-
Protective cover kit INGENIO	10 0021 81	3 24723 013395 6	Bag	1	-	-



EXTENDED FLUSH PLATE FIXING SCREWS

- For use with BCM350, BCU350, BCM790
- Extension to be used when cladding void is between 100mm-250mm.
- Length: 250 mm

M10 TOP CORNER MOUNTING BRACKETS



M12 BOTTOM CORNER MOUNTING BRACKETS

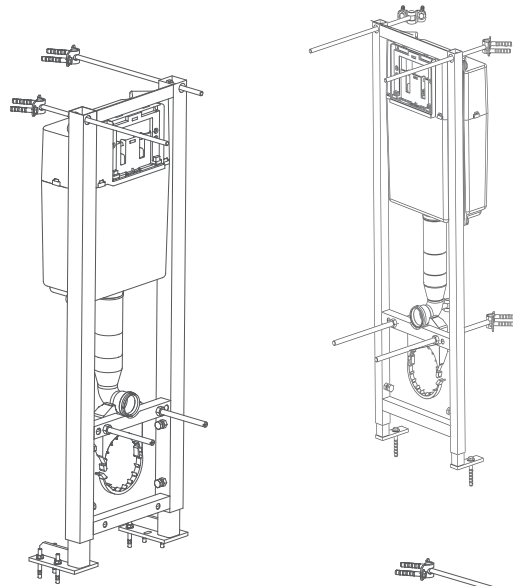

WALL FRAME CORNER INSTALLATION KIT

Two possible installations with the optional corner installation kit.

- 90° corner installation
- 30° angle installation on a single wall
- Suitable for all SIAMP wall frames
- M10 top corner mounting brackets can be installed on wall fixing & self-supporting frames
- M12 bottom corner mounting brackets are for use with wall fixing frames.

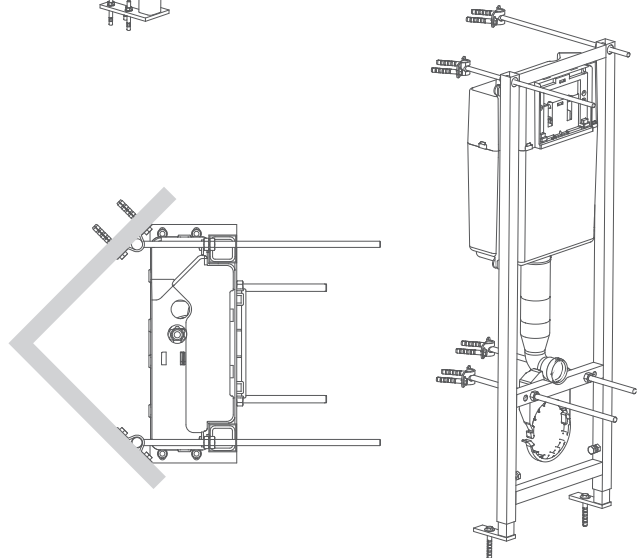

	Ref.	Barcode	Packing	Packing		Pallet quantity
				Nb	Kg	
BCM Extended Flush Plate Fixing Screws (4)	34 1149 46	3 24723 009436 3	Bag	4	-	-
M10 Top corner mounting brackets	34 1064 07	3 24723 009410 3	Bag	1	-	-
M12 bottom corner mounting brackets	34 1065 07	3 24723 009411 0	Bag	1	-	-

CONCEALED CISTERNS

Intended for concealed installations for back to wall or wall hung WC bowls.

INSTALLATION

BEHIND CLADDING

Intraslim B is the product for this type of installation as the flush plate acts as an access panel that will allow for easy maintenance.

Intra Pneumatic allows for remote flushing up to 2m away, the cistern can be reversed 180° for installation in commercial dry risers, for ease of maintenance access.

FURNITURE INSTALLATION

Intra cable has been the choice of bathroom furniture manufacturers for many years, with it's compact dimensions, pre-assembled fittings, adjustable flushpipe and access panel for easy maintenance, Intra is the ideal solution.

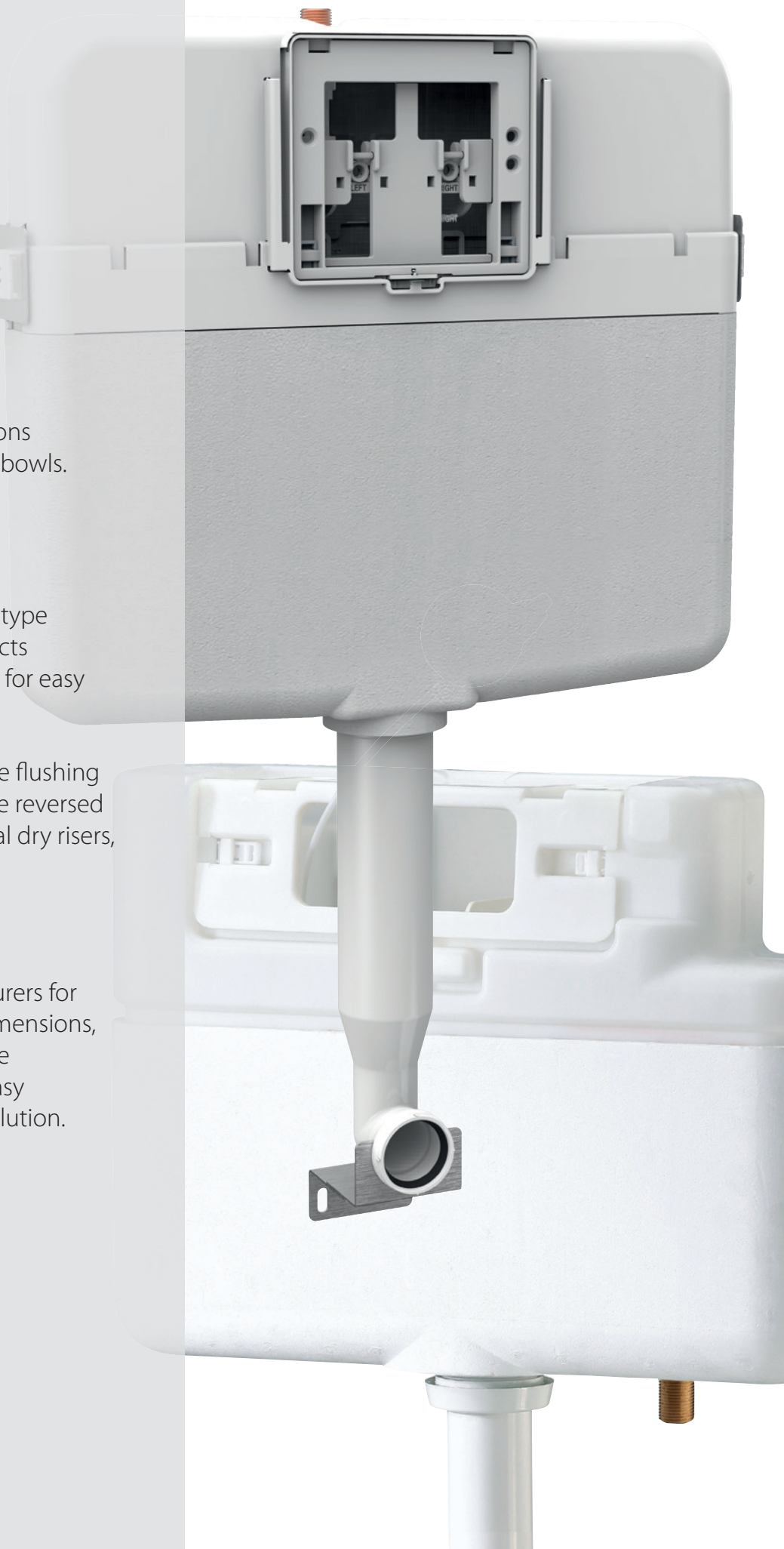



MECHANICAL

p . 37



INTRASLIM B

p. 37

CABLE

p . 37 / 40



INTRA CABLE ECO BOTTOM INLET

p. 37



INTRA CABLE BOTTOM INLET

p. 38



INTRA CABLE SIDE INLET

p. 38



TRUEFLOW

p. 40

PNEUMATIC

p . 39



INTRA PNEUMATIC ECO BOTTOM INLET

p. 39



INTRA PNEUMATIC BOTTOM INLET

p. 39



CONCEALED CISTERN ACCESSORIES

p . 40/ 41



EXTENDED CABLE PUSH BUTTON

p. 40



PNEUMATIC ANTI-VANDAL BUTTON

p. 41



DUAL FLUSH PNEUMATIC BUTTON CHROME

p. 41



SINGLE FLUSH RAISED PNEUMATIC BUTTONS

p. 41

QUICK REFERENCE MATRIX

CISTERNS		INTRASLIM B	INTRA CABLE ECO BOTTOM INLET	INTRA CABLE BOTTOM INLET	INTRA CABLE SIDE INLET	INTRA PN ECO	INTRA PN	TRUEFLOW
Inner equipment	Recessed	•	•	•	•	•	•	•
	Low level	•	•	•	•	•	•	•
	Mechanical outlet valve	•						
	Cable outlet valve		•	•	•			•
	Pneumatic outlet valve					•	•	
	Delayed action		•			•		
	Quiet fill	•	•	•	•	•	•	•
	Brass tail	•	•		•	•		
Supply direction	Top	•						
	Side				•			
	Bottom		•	•		•	•	•
Miscellaneous	Insulated cistern	•	•	•	•	•	•	
	Complete delivery		•	•	•	•	•	•
Dimensions	Width (mm.)	510/570	460	460	460	460	460	436
	Height (mm.)	457	340	340	340	340	340	260
	Depth (mm.)	90	127	127	127	127	127	160
	Wall fixing centers	537 - 557						
Guarantee (years)		10	10	10	10	10	10	10
		•	•	•	•	•	•	•

CONCEALED CISTERNS - MECHANICAL



INTRASLIM B

Ideal for narrow cavity installations

Wide choice of flush plates

- 6/4 litre dual flush, on site adjustable to 4/3.5 litres.
- **Supplied factory assembled for ease of installation**
- Integra 80 flush valve
- **WRAS approved 95L inlet valve**
- 1/2" brass isolation valve
- **Choice of dual flush plates**
- **Access for maintenance through the flush plate**
- Insulated to prevent condensation
- Push-fit flush pipe with reversible fixing bracket

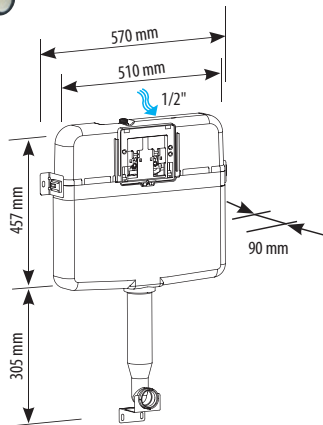

	Ref.	Barcode	Packing	Packing Nb	Packing Kg	Pallet quantity
INTRASLIM B	31 9032 10	3 24723 005275 2	Carton	1	3.7	42

Flush plates [p. 43-51](#)

CONCEALED CISTERNS - CABLE



INTRA CABLE ECO BOTTOM INLET

Designed for furniture

Optimal water saving

- 6/4 litre dual flush, on site adjustable to 4/2.6 litres.
- **Delayed action filling**
- **Supplied factory assembled for ease of installation**
- **WRAS approved Optima 50 flush valve**
- **WRAS approved 99B delayed action inlet valve**
- **1/2" brass inlet connection**
- Access cover allows for top and front entry for maintenance
- Insulated to prevent condensation
- Height and depth adjustable flush pipe
- **Fits 500mm wide compact furniture**

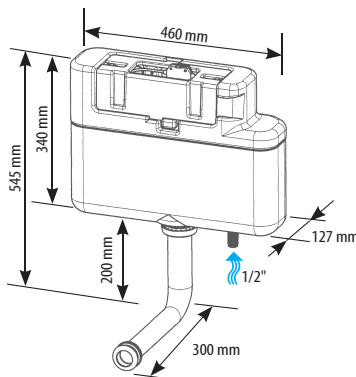

	Ref.	Barcode	Packing	Packing Nb	Packing Kg	Pallet quantity
INTRA CABLE ECO Bottom inlet	31 0150 10	3 24723 009406 6	Carton	1	2.82	96

CONCEALED CISTERNS - CABLE

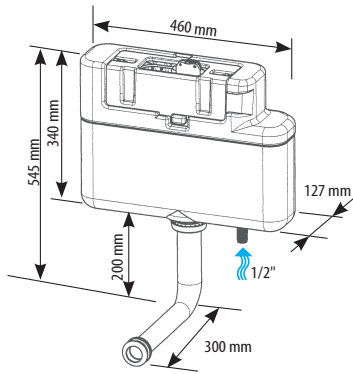

INTRA CABLE BOTTOM INLET

Designed for furniture

Suitable for compact furniture

- 6/4 litre dual flush
- **Supplied factory assembled for ease of installation**
- **WRAS approved Optima 50 flush valve**
- **WRAS approved 99B inlet valve**
- 1/2" inlet connection
- Access cover allows for top and front entry for maintenance
- Insulated to prevent condensation
- Height and depth adjustable flush pipe
- **Fits 500mm wide compact furniture**

	Ref.	Barcode	Packing	Packing Nb	Packing Kg	Pallet quantity
INTRA CABLE Bottom inlet	31 0147 10	3 24723 002372 1	Carton	1	2.82	96

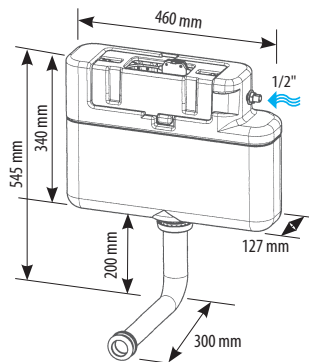

INTRA CABLE SIDE INLET

Designed for furniture

Suitable for compact furniture

- 6/4 litre dual flush
- **Supplied factory assembled for ease of installation**
- **WRAS approved Optima 50 flush valve**
- **WRAS approved 95L inlet valve**
- **1/2" brass inlet connection**
- Access cover allows for top and front entry for maintenance
- Insulated to prevent condensation
- Height and depth adjustable flush pipe
- **Fits 500mm wide compact furniture**

	Ref.	Barcode	Packing	Packing Nb	Packing Kg	Pallet quantity
INTRA CABLE Side inlet	31 0148 10	3 24723 002194 9	Carton	1	2.82	96

CONCEALED CISTERNS - PNEUMATIC

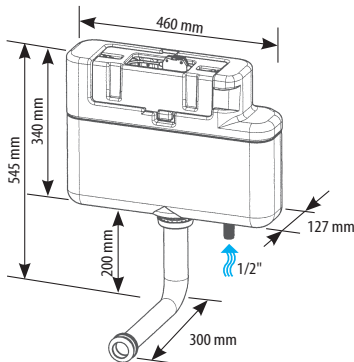

INTRA PNEUMATIC ECO BOTTOM INLET

Ideal for commercial use

Optimal water saving Remote flushing

- 6/4 litre dual flush, on site adjustable to 5/3 litres
- **Delayed action filling**
- **Supplied factory assembled for ease of installation**
- PN 80 flush valve
- **WRAS approved 99B delayed action inlet valve**
- **1/2" brass inlet connection**
- **2m air pipe with corrugated pipe protection**
- **Chrome dual flush button included**
- Access cover allows for top and front entry for maintenance
- Insulated to prevent condensation
- Height and depth adjustable flush pipe

	Ref.	Barcode	Packing	Packing Nb	Packing Kg	Pallet quantity
INTRA PNEUMATIC ECO Bottom inlet	31 0154 10	3 24723 009407 3	Carton	1	2.82	96

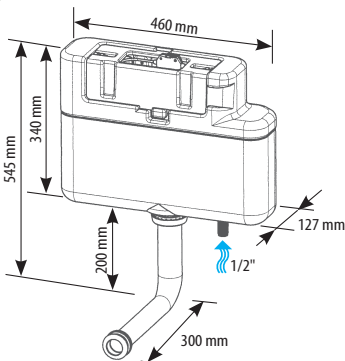

INTRA PNEUMATIC BOTTOM INLET

Ideal for commercial use

Remote flushing

- 6/4 litre dual flush
- **Supplied factory assembled for ease of installation**
- PN 80 flush valve
- **WRAS approved 99B delayed action inlet valve**
- 1/2" inlet connection
- **2m air pipe with corrugated pipe protection**
- **Chrome dual flush button included**
- Access cover allows for top and front entry for maintenance
- Insulated to prevent condensation
- Height and depth adjustable flush pipe

	Ref.	Barcode	Packing	Packing Nb	Packing Kg	Pallet quantity
INTRA PNEUMATIC Bottom inlet	31 0144 11	3 24723 003482 6	Carton	1	2.82	96

CONCEALED CISTERNS - CABLE

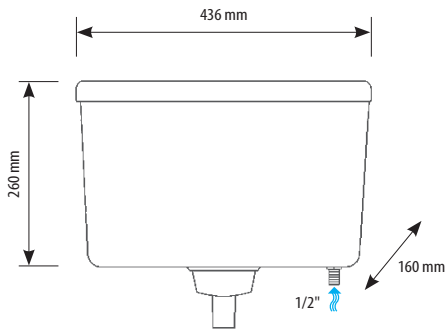

TRUEFLOW

Economical solution

- 6/4 litre dual flush.
- WRAS approved Optima 50 dual flush valve
- WRAS approved 99B inlet valve
- 1/2" inlet connection
- Height and depth adjustable flush pipe

	Ref.	Barcode	Packing	Packing Nb	Packing Kg	Pallet quantity
TRUEFLOW Bottom inlet	31 0147 18	3 24723 002518 3	Carton	1	2.25	106

CONCEALED CISTERN - ACCESSORIES

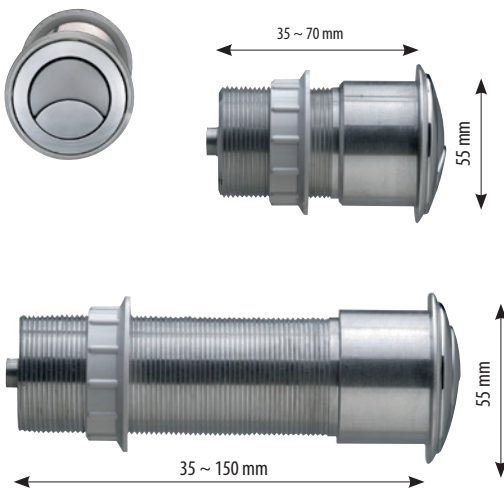

EXTENDED CABLE PUSH BUTTON

- Button made of ABS
- Body made of aluminum
- Cable actuation
- Recessed installation

	Ref.	Barcode	Packing	Packing Nb	Packing Kg
Extended cable button DV800/70	31 5005 10	3 24723 002142 0	Carton	1	0.20
Extended cable button DV800/150	31 5004 10	3 24723 002141 3	Carton	1	0.57



PNEUMATIC ANTI-VANDAL BUTTON

- Plate made of stainless steel
- Tamper-proof system
- Pneumatic actuation
- Dimensions in mm. : h 140 x l 140 x p 8
- For use with Intra Pneumatic



	Ref.	Barcode	Packing	Packing Nb	Packing Kg
Pneumatic Anti-Vandal Single Flush Button S/Steel	31 2552 10	3 24723 003948 7	Carton	1	0.57



DUAL FLUSH PNEUMATIC BUTTON CHROME

- Made from ABS
- Flush sitting buttons
- Pneumatic actuation
- For use with Intra Pneumatic



	Ref.	Barcode	Packing	Packing Nb	Packing Kg
Dual Flush Pneumatic Button Chrome	31 2551 10	3 24723 003790 2	Carton	1	0.25



SINGLE FLUSH RAISED PNEUMATIC BUTTON

- Made from ABS
- Raised button to facilitate activation by people with reduced mobility, seniors or young children
- Pneumatic actuation
- For use with Intra Pneumatic



	Ref.	Barcode	Packing	Packing Nb	Packing Kg
Single Flush Raised Pneumatic Button White	31 2535 10	3 24723 002496 4	Carton	1	0.25
Single Flush Raised Pneumatic Button Chrome	31 2555 10	3 24723 003791 9	Carton	1	0.25

FLUSH PLATES

FLUSHING OPTIONS:

MECHANICAL ACTUATION:

The most popular flushing mode on the market, efficient flushing and simplicity of installation.

AUTOMATIC OPERATION:

This system is the preferred solution for public places to ensure that the WC will always be clean and available for the next use.

INSPIRED COLLECTIONS:

DESIGN: Available in different models and various decorative finishes, lightweight and resistant to shocks.

MATERIAL: The purity of tempered glass with its clean forms, the Reflet range offers elegant control plates with depth effects.

CREATIVE: Following current trends, our range of creative plates will allow you to achieve a welcoming and original look thanks to a choice of colours and styles.

ESSENTIAL: Simple but effective, lightweight and resistant to shocks.

COMMERCIAL: Aluminum alloy, heavy weight and durable.
Anti-vandal and infrared options.



INSPIRATION

p . 45 / 49

DESIGN



SPHERE

p. 45



SMARTY

p. 49



SQUARE

p. 48



SEGMENT

p. 48

MATERIAL



SMART

p. 49



REFLET

p. 46

CREATIVE



ALBUM

p. 47

ESSENTIAL

p . 50



YIN YANG

p. 50



LEMON

p. 50

COMMERCIAL

p . 51



MONOVOLUME

p. 51



SMART IR

p. 51



PRODUCT FEATURES

Our range

MATERIALS

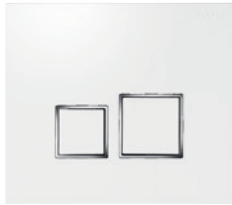

ABS

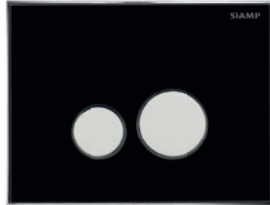

Glass



Wood

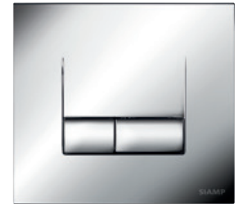

Metal

PERSONALISATION

DECORATION WITH CHOICE

A wide selection of decors and textures to choose from.

*minimum order quantities apply, enquire for further information.

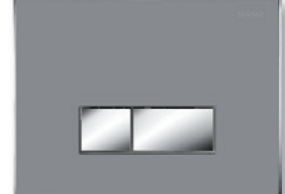

Quick reference matrix

Wall frames & Cisterns	INGENIO	BCM - BCU 350	BCM 790	INTRASLIM B
Flushing options				
Sphere	•			
Square	•	•	•	•
Segment	•	•	•	•
Smarty	•	•	•	•
Reflet	•	•	•	•
Album	•	•	•	•
Ying Yang		•	•	•
Lemon		•	•	•
Smart	•	•	•	•
Smart infra-red		•		
Monovolume		•	•	•

SPHERE
White

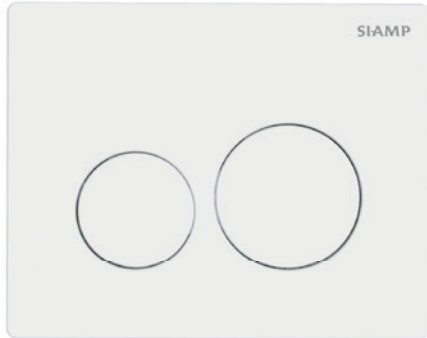

SPHERE INGENIO

Round design with soft edges

- Material: ABS
- Flush: Dual flush
- Activation: Mechanical
- Activation force: <20N
- Size: H: 164mm W: 207mm D: 8.5mm
- Min cladding thickness 13mm
- Compatible with: INGENIO

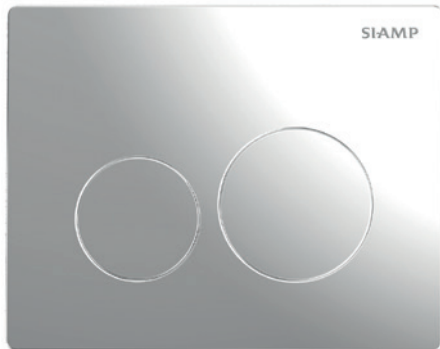

SPHERE
Chrome

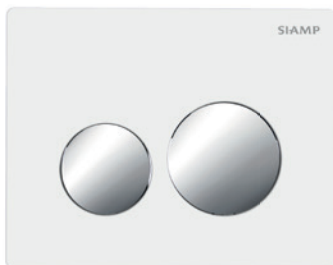

SPHERE
White / Chrome



SPHERE
Matt Chrome

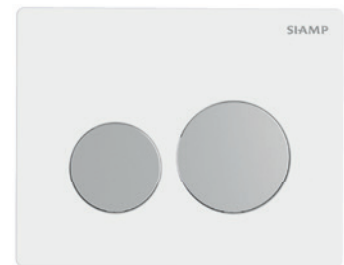

SPHERE
White / Matt Chrome

	Ref.	Barcode	Packing	Packing	
				Nb	Kg
SPHERE White	31 2610 60	3 24723 009947 2	Box	1	0.40
SPHERE Chrome	31 2612 60	3 24723 009943 6	Box	1	0.40
SPHERE White / Chrome	31 2614 60	3 24723 009945 0	Box	1	0.40
SPHERE Matt Chrome	31 2611 60	3 24723 009942 9	Box	1	0.40
SPHERE White / Matt Chrome	31 2613 60	324723 009944 3	Box	1	0.40

FLUSH PLATES - INSPIRATION

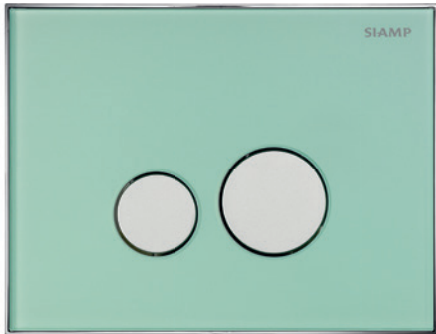

REFLET 360
Natural Green



REFLET 360
Black



REFLET 360
White

REFLET 360

Clarity and depth of glass

- Material: Glass with matt chrome ABS buttons
- Flush: Dual flush
- Activation: Mechanical
- Activation force: <20N
- Size: H: 180mm W: 236mm D: 13mm
- Min cladding thickness 20mm
- Compatible with: INGENIO, BCM/BCU350, BCM790, Intraslim

	Ref.	Barcode	Packing	Packing	
				Nb	Kg
REFLET 360 Natural green / Matt chrome	31 1982 10	3 24723 002358 5	Box	1	1.2
REFLET 360 Black / Matt chrome	31 1981 10	3 24723 002359 2	Box	1	1.2
REFLET 360 White/ Matt chrome	31 1984 10	3 24723 004210 4	Box	1	1.2

REFLET 360 INGENIO Natural green / Matt chrome	31 1982 60	3 24723 009891 0	Box	1	1.2
REFLET 360 INGENIO Black / Matt chrome	31 1981 60	3 24723 009890 3	Box	1	1.2
REFLET 360 INGENIO White White / Matt chrome	31 1984 60	3 24723 009889 7	Box	1	1.2



REFLET 90

Clarity and depth of glass

- Material: Glass with matt chrome ABS buttons
- Flush: Dual flush
- Activation: Mechanical
- Activation force: <20N
- Size: H: 180mm W: 236mm D: 13mm
- Min cladding thickness 20mm
- Compatible with: INGENIO, BCM/BCU350, BCM790, Intraslim



REFLET 90
Natural Green



REFLET 90
Black



REFLET 90
White

	Ref.	Barcode	Packing	Packing	
				Nb	Kg
REFLET 90 Natural green / Matt chrome	31 1932 10	3 24723 002286 1	Box	1	1.2
REFLET 90 Black / Matt chrome	31 1931 10	3 24723 002285 4	Box	1	1.2
REFLET 90 White/ Matt chrome	31 1934 10	3 24723 004212 8	Box	1	1.2

REFLET 90 INGENIO Natural green / Matt chrome	31 1932 60	3 24723 009898 9	Box	1	1.2
REFLET 90 INGENIO Black / Matt chrome	31 1931 60	3 24723 009859 0	Box	1	1.2
REFLET 90 INGENIO White/ Matt chrome	31 1934 60	3 24723 009861 3	Box	1	1.2



Album 360
Black



Album 360
Natural Oak

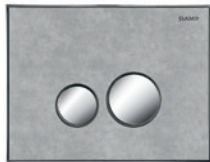

Album 360
Stone Grey

ALBUM 360

Creative decors

- Material: Decorative HPL with bright chrome ABS buttons
- Flush: Dual flush
- Activation: Mechanical
- Activation force: <20N
- Size: H: 180mm W: 236mm D: 13mm
- Min cladding thickness 20mm
- Compatible with: INGENIO, BCM/BCU350, BCM790, Intraslim

	Ref.	Barcode	Packing	Packing	
				Nb	Kg
ALBUM 360 Black	31 1792 10	3 24723 005130 4	Box	1	1.2
ALBUM 360 Natural Oak	31 1790 10	3 24723 005126 7	Box	1	1.2
ALBUM 360 Stone Grey	31 1791 10	3 24723 005128 1	Box	1	1.2

ALBUM 360 INGENIO Black	31 1792 60	3 24723 009882 8	Box	1	1.2
ALBUM 360 INGENIO Natural Oak	31 1790 60	3 24723 009880 4	Box	1	1.2
ALBUM 360 INGENIO Stone Grey	31 1791 60	3 24723 009881 1	Box	1	1.2



ALBUM 90

Creative decors

- Material: Decorative HPL with bright chrome ABS buttons
- Flush: Dual flush
- Activation: Mechanical
- Activation force: <20N
- Size: H: 180mm W: 236mm D: 13mm
- Min cladding thickness 20mm
- Compatible with: INGENIO, BCM/BCU350, BCM790, Intraslim

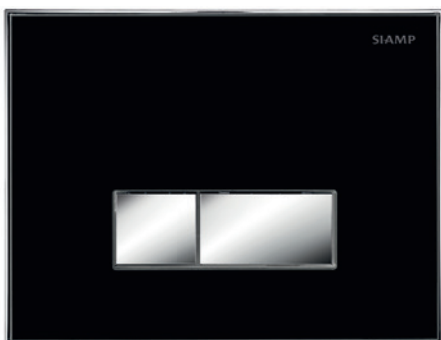

Album 90
Black



Album 90
Natural Oak



Album 90
Stone Grey

	Ref.	Barcode	Packing	Packing	
				Nb	Kg
ALBUM 90 Black	31 1692 10	3 24723 005136 6	Box	1	1.2
ALBUM 90 Natural Oak	31 1690 10	3 24723 005134 2	Box	1	1.2
ALBUM 90 Stone Grey	31 1691 10	3 24723 005135 9	Box	1	1.2

ALBUM 90 INGENIO Black	31 1692 60	3 24723 009887 3	Box	1	1.2
ALBUM 90 INGENIO Natural Oak	31 1690 60	3 24723 009885 9	Box	1	1.2
ALBUM 90 INGENIO Stone Grey	31 1691 60	3 24723 009886 6	Box	1	1.2

FLUSH PLATES - INSPIRATION

SEGMENT
White & Bright chrome inserts

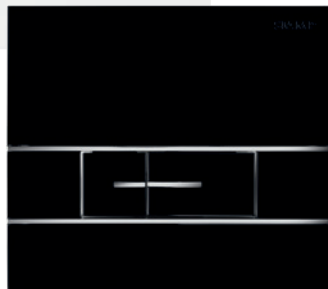

SEGMENT
Black & Bright chrome inserts



SEGMENT
Stainless steel finish & Bright chrome inserts



SEGMENT
Bright chrome & Matt chrome inserts

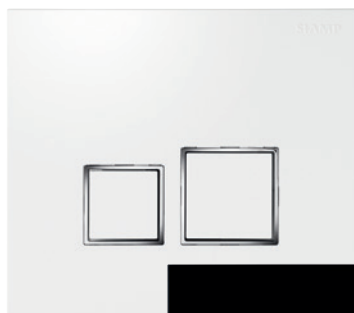

SQUARE
White & Bright chrome inserts

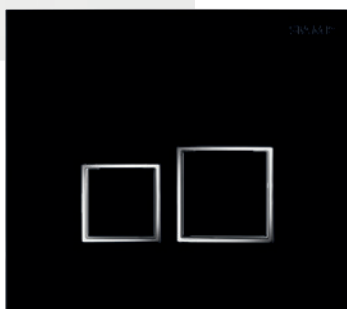

SQUARE
Black & Bright chrome inserts



SQUARE
Stainless steel finish & Bright chrome inserts



SQUARE
Bright chrome & Matt chrome inserts



SEGMENT

Segmented by delicate chrome inserts

- Material: ABS
- Flush: Dual flush
- Activation: Mechanical
- Activation force: <20N
- Size: H: 180mm W: 200mm D: 8.5mm
- Min cladding thickness 13mm* / 16mm
- Compatible with: INGENIO, BCM/BCU350, BCM790, Intraslim

	Ref.	Barcode	Packing	Packing	
				Nb	Kg
SEGMENT White / Bright chrome inserts	31 1710 10	3 24723 002417 9	Box	1	0.40
SEGMENT Black / Bright chrome inserts	31 1711 10	3 24723 002418 6	Box	1	0.40
SEGMENT Stainless steel finish / Bright chrome inserts	31 1712 10	3 24723 002419 3	Box	1	0.40
SEGMENT Bright chrome / Matt chrome inserts	31 1722 10	3 24723 002422 3	Box	1	0.40

SEGMENT INGENIO White / Bright chrome inserts	31 1710 60	3 24723 009903 0	Box	1	0.40
SEGMENT INGENIO Black / Bright chrome inserts	31 1711 60	3 24723 009904 7	Box	1	0.40
SEGMENT INGENIO Stainless steel finish / Bright chrome inserts	31 1712 60	3 24723 009905 4	Box	1	0.40
SEGMENT INGENIO Bright chrome / Matt chrome inserts	31 1722 60	3 24723 009906 1	Box	1	0.40



SQUARE

True square design with chrome inserts

- Material: ABS
- Flush: Dual flush
- Activation: Mechanical
- Activation force: <20N
- Size: H: 180mm W: 200mm D: 8.5mm
- Min cladding thickness 13mm* / 16mm
- Compatible with: INGENIO, BCM/BCU350, BCM790, Intraslim

	Ref.	Barcode	Packing	Packing	
				Nb	Kg
SQUARE White / Bright chrome inserts	31 2040 10	3 24723 002425 4	Box	1	0.41
SQUARE Black / Bright chrome inserts	31 2041 10	3 24723 002426 1	Box	1	0.41
SQUARE Stainless steel finish / Bright chrome inserts	31 2042 10	3 24723 002427 8	Box	1	0.41
SQUARE Bright chrome / Matt chrome inserts	31 2072 10	3 24723 002430 8	Box	1	0.41

SQUARE INGENIO White / Bright chrome inserts	31 2040 60	3 24723 009899 6	Box	1	0.41
SQUARE INGENIO Black / Bright chrome inserts	31 2041 60	3 24723 009900 9	Box	1	0.41
SQUARE INGENIO Stainless steel finish / Bright chrome inserts	31 2042 60	3 24723 009901 6	Box	1	0.41
SQUARE INGENIO Bright chrome / Matt chrome inserts	31 2072 60	3 24723 009902 3	Box	1	0.41

*Min. cladding thickness applies to INGENIO only

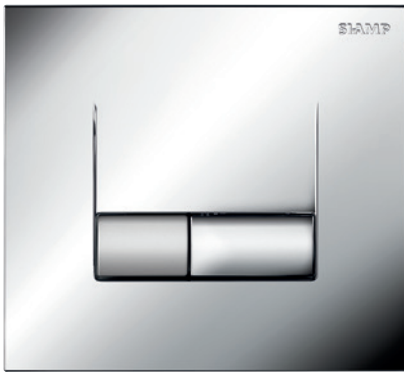

SMARTY
Bright chrome



SMARTY
Matt chrome

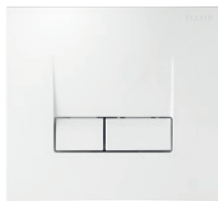

SMARTY
White



SMARTY

Contemporary design

- Material: ABS
- Flush: Dual flush
- Activation: Mechanical
- Activation force: <20N
- Size: H: 180mm W: 200mm D: 11mm
- Min cladding thickness 13mm* / 16mm
- Compatible with: INGENIO, BCM/BCU350, BCM790, Intraslim

	Ref.	Barcode	Packing	Packing	
				Nb	Kg
SMARTY Bright chrome / Matt chrome	31 1912 10	3 24723 002090 4	Box	1	0.39
SMARTY Matt chrome / Bright chrome	31 1911 10	3 24723 002088 1	Box	1	0.39
SMARTY White	31 1910 10	3 24723 002087 4	Box	1	0.39

SMARTY INGENIO Bright chrome / Matt chrome	31 1912 60	3 24723 009843 9	Box	1	0.39
SMARTY INGENIO Matt chrome / Bright chrome	31 1911 60	3 24723 009842 2	Box	1	0.39
SMARTY INGENIO White	31 1910 60	3 24723 009841 5	Box	1	0.39



SMART
Bright chrome



SMART
Matt chrome



SMART

Metal integrity

- Material: Aluminium
- Flush: Dual flush
- Activation: Mechanical
- Activation force: <20N
- Size: H: 180mm W: 200mm D: 11mm
- Min cladding thickness 13mm* / 16mm
- Compatible with: INGENIO, BCM/BCU350, BCM790, Intraslim
- Fingerprint resistant coating on Matt Chrome version

	Ref.	Barcode	Packing	Packing	
				Nb	Kg
SMART Bright chrome & Vandal resistant	31 1874 10	3 24723 001958 8	Box	1	0.8
SMART Matt chrome & Vandal resistant / Fingerprints proof	31 1872 10	3 24723 002073 7	Box	1	0.8

SMART INGENIO Bright chrome & Vandal resistant	31 1874 60	3 24723 009853 8	Box	1	0.8
SMART INGENIO Matt chrome & Vandal resistant / Fingerprints proof	31 1872 60	3 24723 009852 1	Box	1	0.8

*Min. cladding thickness applies to INGENIO only

FLUSH PLATES - ESSENTIAL



YIN YANG

- Material: ABS
- Flush: Dual flush
- Activation: Mechanical
- Activation force: <20N
- Size: H: 180mm W: 200mm D: 22mm
- Min cladding thickness 16mm
- Compatible with: BCM/BCU350, BCM790, Intraslim

	Ref.	Barcode	Packing	Packing	
				Nb	Kg
YIN YANG White	31 1800 10	3 24723 001304 3	Box	1	0.35
YIN YANG Bright chrome	31 1853 16	3 24723 001899 4	Box	1	0.35
YIN YANG Bright chrome / Matt chrome	31 1853 10	3 24723 001489 7	Box	1	0.35
YIN YANG Matt chrome / Bright chrome	31 1853 16	3 24723 001899 4	Box	1	0.35

LEMON
Bright chrome



LEMON
Matt chrome



LEMON

- Material: ABS
- Flush: Dual flush
- Activation: Mechanical
- Activation force: <20N
- Size: H: 180mm W: 200mm D: 8.5mm
- Min cladding thickness 16mm
- Compatible with: BCM/BCU350, BCM790, Intraslim

	Ref.	Barcode	Packing	Packing	
				Nb	Kg
LEMON Bright chrome	31 1814 10	3 24723 001680 8	Box	1	0.38
LEMON Matt chrome	31 1813 10	3 24723 001679 2	Box	1	0.38



MONOVOLUME ANTI-VANDAL

Anti vandal

- Material: Aluminium
- Flush: Single flush
- Activation: Mechanical
- Activation force: <20N
- Size: H: 180mm W: 200mm D: 24mm
- Min cladding thickness 16mm
- Compatible with: BCM/BCU350, BCM790, Intraslim B

	Ref.	Barcode	Packing	Packing	
				Nb	Kg
MONOVOLUME ANTI-VANDAL stainless steel	31 1888 10	3 24723 001408 8	Box	1	0.68



SMART INFRARED

Contactless flushing

- Mains or Battery
- Material: Aluminium alloy
- Flush: Single flush
- Activation: Automatic
- Size: H: 180mm W: 200mm D: 24mm
- Min cladding thickness 16mm
- Compatible with: BCM/BCU350
- Manual override to allow flushing in the event of power loss

	Ref.	Barcode	Packing	Packing	
				Nb	Kg
SMART INFRARED MAINS Matt chrome	31 1950 10	3 24723 002148 2	Box	1	1.5
SMART INFRARED BATTERY Matt chrome	31 1954 10	3 24723 003452 9	Box	1	1.5

TECHNICAL EQUIPMENT

Chosen by many global bathroom brands to equip their cisterns, the SIAMP range of inlet valves and flush valves offers quality and durability, guaranteed by WRAS and many other international standards.

Made with premium and recyclable raw materials, our products are continually tested and certified with manufacturing and product sustainability in mind, meaning SIAMP can offer a 10 year guarantee.







Expectations of comfort (quiet, ease of operation, simple to install) and water saving has led to the development of innovative solutions covered by numerous international patents.











INLET VALVES

p . 55 / 57

	COMPACT 100 DELAYED ACTION	p. 55
	COMPACT 99T	p. 55
	COMPACT 99T DELAYED ACTION	p. 56
	COMPACT 99B	p. 56
	QUIETO DELAYED ACTION	p. 57
	COMPACT 95L	p. 57



FLUSH VALVES

p . 59 / 61

	OPTIMA S	p. 59
	OPTIMA 50	p. 59
	OPTIMA 49	p. 60
	SKIPPER 45	p. 60
	STORM 33A	p. 61
	UNISIPHON	p. 61

COMPONENT PACKS

p . 62

	DELUXE OPTIMA 50 / 99T	p. 62
	ECO DELUXE OPTIMA S / 99T DELAYED ACTION	p. 62

ACCESSORIES & SPARE PARTS

p . 63

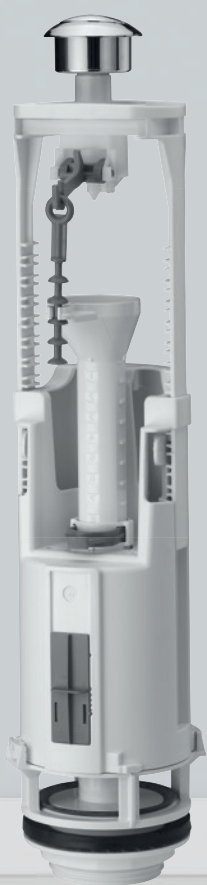

INLET VALVES		100 00	Compact 99T	Compact 99T Delayed Action	Compact 99B	Quieto	Compact 95L
Entry	Side	•				•	•
	Bottom	•	•	•	•		
Closure	Hydraulical	•	•	•	•	•	•
	Mechanical						
Connection	3/8" brass		•			•	•
	1/2" brass		•	•			•
	1/2" plastic	•	•		•		•
Dimensions	Length (mm)	81,5	75,5	92	75,5	112	112
	Width (mm)	62,9	53	66	53	69	50
	Height (from connection axis) (mm)	284	235 ~ 344	240 ~ 330	282	256	270
Certifications		•	•	•	•		•
	Guarantee (years)	10	10	10	10	10	10

Water saving



150l
per person

WC FLUSHING
up to
22%

The average UK household consumes **150 litres of water per person, per day.**

22% of this consumption is associated to flushing the WC.

Our range of delayed action inlet valves contribute to saving water with two functions.

- **the first is to delay the inlet valve from re-filling the cistern until the flush valve has closed.**

Saving water from being wasted during the flushing cycle.

- **the second is to maintain a consistent volume of water entering the cistern.**

As the cistern refills with speed, the water spills over into the box, rapidly lifting the float for a quick, reliable shut off.



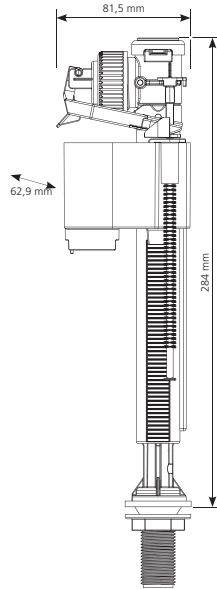

COMPACT 100 DELAYED ACTION

Water saving

Save up to 3L per day *

- **Delayed action**
- Compact body
- **Low pressure**
- Quiet fill
- Anti-backflow
- **1/2" Plastic tail**
- Pressure range 0.1-10 bars

	Ref.	Barcode	Packing	Packing Nb	Packing Kg	Pallet quantity
COMPACT 100 Delayed Action 1/2" Plastic	10 0021 63	3 24723 013343 7	Bag	60	-	900

*based on a dwelling with 1 bar pressure and 4 occupants.

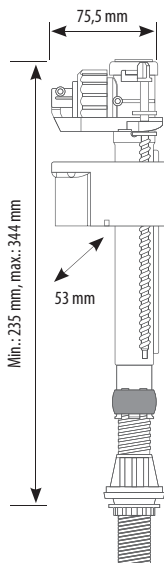

COMPACT 99T TELESCOPIC

Maximum adjustment

- **Telescopic**
- Compact body
- **Low pressure**
- Anti-backflow
- **1/2" Brass, 3/8" Brass, 1/2" Plastic options**
- Pressure range 0.1-10 bars

	Ref.	Barcode	Packing	Packing Nb	Packing Kg	Pallet quantity
COMPACT 99T 1/2" Brass Telescopic	30 9921 10	3 24723 006952 1	Box	24	8.5	360
COMPACT 99T 3/8" Brass Telescopic	30 9922 10	3 24723 006953 8	Box	24	8	360
COMPACT 99T 1/2" Plastic Telescopic	30 9980 10	3 24723 007127 2	Box	24	8	360

INLET VALVES

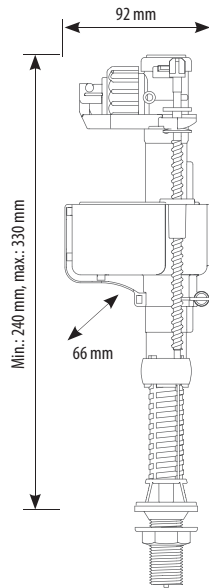

COMPACT 99T TELESCOPIC DELAYED ACTION

Water saving

Save up to 3l per day*

- Telescopic
- Delayed action
- Low pressure
- Quiet fill
- Anti-backflow
- **1/2" Brass tail**
- Pressure range 0.1-10 bars

	Ref.	Barcode	Packing	Packing		Pallet
				Nb	Kg	quantity
COMPACT 99T Delayed action 1/2" Brass	30 9923 10	3 24723 006954 5	Box	24	9.7	360

*based on a dwelling with 1 bar pressure and 4 occupants.

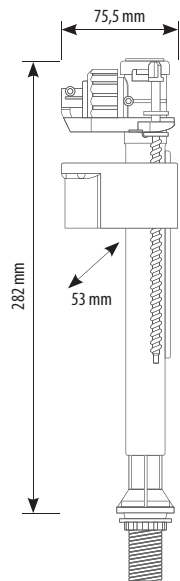

COMPACT 99B

- Compact body
- Quiet fill
- Anti-backflow
- **1/2" Plastic tail**
- Pressure range 0.5-10 bars

	Ref.	Barcode	Packing	Packing		Pallet
				Nb	Kg	quantity
COMPACT 99B 1/2" Plastic	30 9960 07	3 24723 001282 4	Bag	60	18.8	900



QUIETO DELAYED ACTION

Ultra quiet & water saving

Save up to 3l per day*

- Ultra quiet 9 dB
- Delayed action
- Anti-backflow
- 3/8" Brass tail
- Pressure range 0.5-10 bars

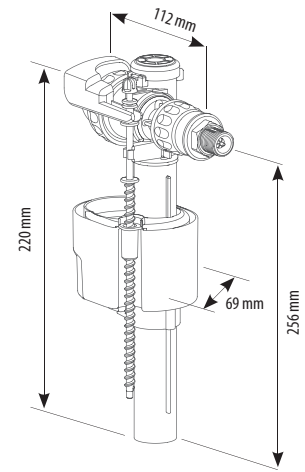
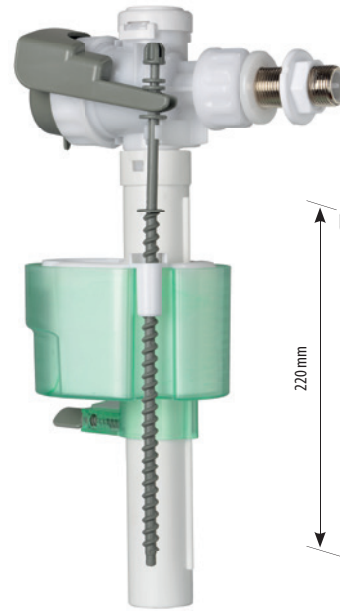

	Ref.	Barcode	Packing	Packing Nb	Packing Kg	Pallet quantity
Quieto	30 7781 10	3 24723 007126 5	Box	20	7.08	300

*based on a dwelling with 1 bar pressure and 4 occupants.

WATCH OUR NEW VIDEO
TO FIND OUT MORE
ABOUT QUIETO



Supplied with 3/8" + 1/2" Brass connections

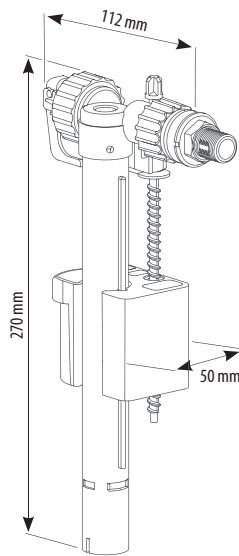
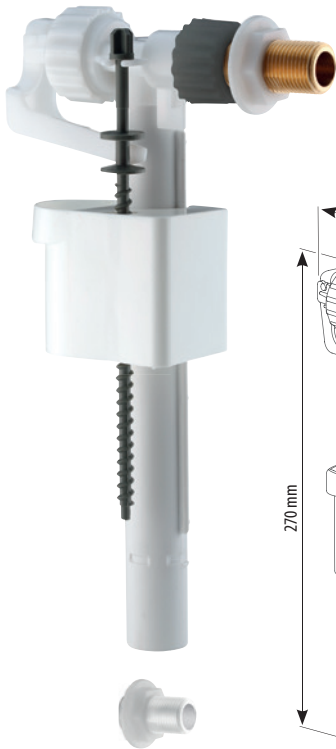

Available in 1/2" plastic



COMPACT 95L

- Compact body
- Quiet fill
- Anti-backflow
- 3/8" + 1/2" Brass, 1/2" Plastic options
- Pressure range 0.5-10 bars

	Ref.	Barcode	Packing	Packing Nb	Packing Kg	Pallet quantity
COMPACT 95L 3/8" + 1/2" BRASS	30 9565 10	3 24723 007068 8	Box	24	9.6	360
COMPACT 95L 1/2" Plastic	30 9506 07	3 24723 001493 4	Bag	50	14.5	750

QUICK REFERENCE MATRIX

FLUSH VALVES		Optima S	Optima 50	Optima 49	Skipper 45	Storm 33A
Actuation system	Dual flush	•	•	•	•	
	Single flush					•
Adjustability	Ø Lid hole (mm)	16~40	16~40	16~50	40~44	18~40
	Cistern height (mm)	282~432	272~480	285~448	305~455	305~415
	Overflow height (mm)	185~325	149~245	155~245	180~240	180~240
Certifications		•	•	•	•	•
Guarantee (years)		10	10	10	10	10

Universal bayonet



One bayonet interchangeable with all SIAMP flush mechanisms, release the mechanism easily from the bayonet without disassembling the tank:

Simple maintenance and replacement

→ **No need to remove the cistern**

TELESCOPIC OVERFLOW

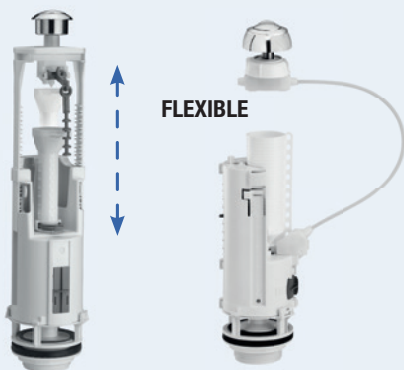

ADJUSTABLE HEIGHT

by sliding stirrup, matches most of the cisterns of the market

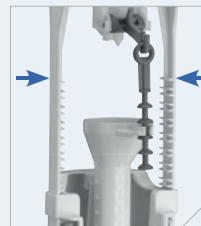

ADJUSTABLE SMALL FLUSH
with notches

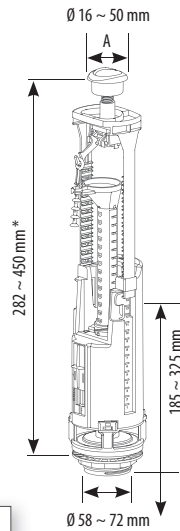
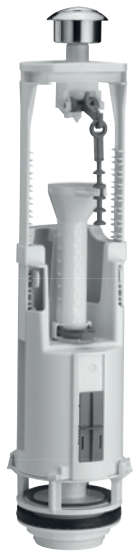

Raised button available (see page 63 for more details)



OPTIMA S

Fully adjustable

Telescopic overflow

- Dual flush
- Height adjustable
- Telescopic overflow
- High flow rate 3.5l/s
- Easy removal for maintenance

	Ref.	Barcode	Packing	Packing Nb	Packing Kg	Pallet quantity
OPTIMA S	32 7004 10	3 24723 009267 3	Box	14	9	210

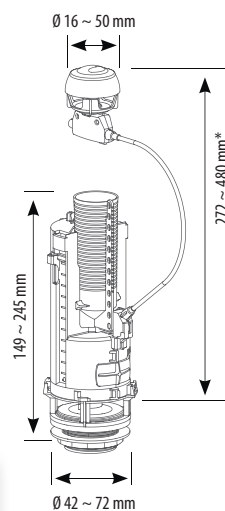

1/2" strainer



Raised button available (see page 63 for more details)



OPTIMA 50

Flexibility for all

Adaptable to any installation

- Dual flush
- Button can be located on front, top or side of cistern
- **Cable length 470mm**
- Supplied with **2" & 1 1/2" strainer**
- High flow rate 3.5l/s
- Easy removal for maintenance

	Ref.	Barcode	Packing	Packing Nb	Packing Kg	Pallet quantity
OPTIMA 50	32 5002 10	3 24723 007130 2	Box	14	7.6	210

FLUSH VALVES

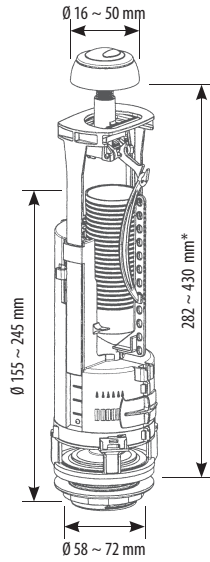

Raised button available (see page 63 for more details)



OPTIMA 49

Quick adjustment

- Dual flush
- Height adjustable
- Adjustable overflow
- High flow rate 3.5l/s
- Easy removal for maintenance

	Ref.	Barcode	Packing	Colisage Nb	Kg	Pallet quantity
OPTIMA 49	32 4999 10	3 24723 007129 6	Box	14	9	210

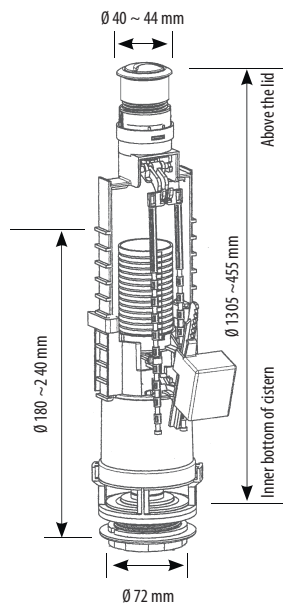

SKIPPER 45

- Dual flush
- Height adjustable
- Adjustable overflow
- High flow rate 3.5l/s
- Easy removal for maintenance

	Ref.	Barcode	Packing	Packing Nb	Kg	Pallet quantity
SKIPPER 45	32 4560 10	3 24723 007132 6	Box	14	7.05	210

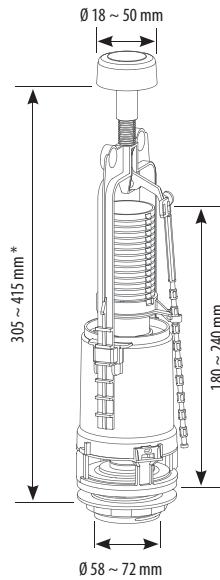
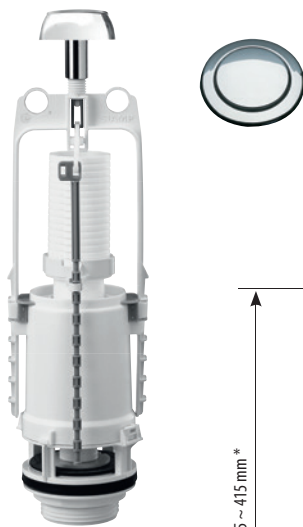

STORM 33A

- Single flush
- **Height adjustable**
- **Adjustable overflow**
- High flow rate 3.5l/s
- Easy removal for maintenance

	Ref.	Barcode	Packing	Packing Nb	Packing Kg	Pallet quantity
STORM 33A	32 3355 10	3 24723 007131 9	Box	14	7	210

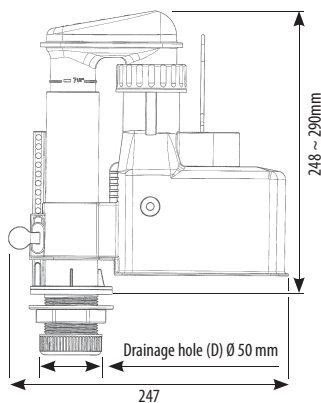

UNISIPHON

Ideal for replacing original equipment

- Height adjustable between **7 1/2" (248mm) & 9 1/2" (290mm)**
- Adjustable flush volume between 6L - 9L
- **Internal overflow**
- Adjustable dead water level
- Two part for easy maintenance

	Ref.	Barcode	Packing	Packing Nb	Packing Kg	Pallet quantity
UNISIPHON	32 8004 07	3 24723 007197 5	Bag c/w Header card	12	8	180

COMPONENT PACKS



DELUXE OPTIMA 50 / 99T COMPONENT PACK

	Ref.	Barcode	Packing	Packing Nb	Packing Kg	Pallet quantity
OPTIMA 50/99T 1/2" brass deluxe component pack	37 9981 10	3 24723 007128 9	Box	9	8.75	135

ECO DELUXE OPTIMA S / 99T DELAYED ACTION COMPONENT PACK

	Ref.	Barcode	Packing	Packing Nb	Packing Kg	Pallet quantity
OPTIMA S/99T 1/2" brass deluxe component pack	37 9411 10	3 24723 009146 1	Box	9	9.2	135



OPTIMA 50 / 99B COMPONENT PACK

	Ref.	Barcode	Packing	Packing Nb	Packing Kg	Pallet quantity
OPTIMA 50/99B component pack	37 9980 07	3 24723 002373 8	Bag	16	13.2	240



OPTIMA 49 / 99B COMPONENT PACK

	Ref.	Barcode	Packing	Packing Nb	Packing Kg	Pallet quantity
OPTIMA 49/99B component pack	37 9801 07	3 24723 004729 1	Bag	14	11.3	210



SKIPPER 45 / 99B COMPONENT PACK

	Ref.	Barcode	Packing	Packing Nb	Packing Kg	Pallet quantity
SKIPPER 45/99B component pack	33 9950 07	3 24723 007142 5	Bag	15	12	225



STORM 33 / 99B COMPONENT PACK

	Ref.	Barcode	Packing	Packing Nb	Packing Kg	Pallet quantity
STORM 33/99B component pack	35 9950 07	3 24723 007143 2	Bag	15	9	225

All component packs are supplied with pan to cistern coupling bolts and doughnut washer.



**PAN TO CISTERN
COUPLING BOLTS**

Ref. 34504107



**CLOSE COUPLING
PLATE & BOLT SET**

Ref. 34508207



**DOUGHNUT
WASHER**

Ref. 34031909



CABLE FOR OPTIMA 50

- 750 mm Ref. 34495709
- 470 mm Ref. 34495309
- 315 mm Ref. 34498009



**OPTIMA S
PUSH BUTTON**

Ref. 34705009



**OPTIMA 49
PUSH BUTTON**

Ref. 34494909



**OPTIMA 50
PUSH BUTTON**

Ref. 34495009



**SKIPPER 45
PUSH BUTTON**

Ref. 34455009



**STORM 33A
PUSH BUTTON**

Ref. 34335009



**OPTIMA 49 / S RAISED
PUSH BUTTON**

Ref. 34505407



**OPTIMA 50 RAISED
PUSH BUTTON**

Ref. 34505107



**OPTIMA 50 LARGE (60MM)
PUSH BUTTON**

Ref. 34497107



**STORM/SKIPPER
OUTLET SEAL**

Ref. 34233209



**OPTIMA OUTLET
SEALS**

Ref. 34490509



**DIAPHRAGM
WASHER**

Ref. 34951309



**UNISIPHON
DIAPHRAGM**

Ref. 34460700

TOILET SEATS

THE VARIOUS MATERIALS OF OUR TOILET SEATS:

- **THERMOSET:**

Heavy duty, manufactured with high quality antibacterial and scratch-resistant materials.

- **THERMOPLASTIC:**

Economical, hard wearing and made with recyclable material.

- **COMPOSITE WOOD:**

The most robust material, dedicated to luxury products, offering a high quality finish.

- **MDF:**

Medium-density fibreboard, with the aesthetics and warmth of wood.

HINGE OPTIONS:

- **PREMIUM:**

Quick fitting, soft close and detachable. Designed for both comfort and hygiene.

- **CLASSIC:**

Products intended for intensive use, suitable for commercial use.







- **BAR HINGE:**

Solid and durable





THERMOSET

p . 68 / 71

	AZUR PREMIUM SLIM	p. 68
	PRINCIPAUTÉ PREMIUM	p. 68
	VENCE PREMIUM	p. 69
	ESTÉREL PREMIUM	p. 69
	ESTÉREL CLASSIC	p. 70
	MOUGINS CLASSIC	p. 70
	PMR	p. 71

THERMOPLASTIC

p . 71 / 72

	GÉNÉRATIONS PREMIUM	p. 71
	MONTE CARLO 3	p. 72

MDF

p . 72

	HORIZON CLASSIC	p. 72
---	------------------------	-------

COMPOSITE WOOD

p . 73

	CAP FERRAT PREMIUM	p. 73
	CAP FERRAT CLASSIC	p. 73

PRODUCT FEATURES

Material

THERMOSET

- Antibacterial
- Scratch resistant
- Chemical resistant
- High quality finish

COMPOSITE WOOD

- Highly robust
- Antibacterial
- Highly moisture resistant
- Maintains warmth

THERMOPLASTIC

- Hard wearing
- Recyclable material

MDF

- Rigid

Design



Fixing system

STAINLESS STEEL

- **Top fixing** : Fast and effortless installation

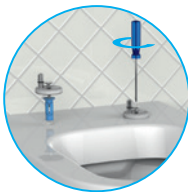

- **Bottom fixing** : For standard WC bowls



PLASTIC

- **Plastic bar** : Durable and colour matched to the seat



Solutions

SOFT CLOSE



- **Quiet**: Seat & lid close slowly and quietly
- **Hygienic**: Minimal contact required to begin the closure
- **Safe**: Prevention of slamming and trapped fingers, child friendly.

QUICK RELEASE



- **Hygienic**: Easy cleaning of the WC

ADJUSTABLE



- **Large adjustment range**
- Expanding fixing for secure fit

DURABLE



- Corrosion resistant
- Fast fix nut for quick installation

TOILET SEATS		Azur Premium Slim	Principauté Premium	Vence Premium	Estérel Premium	Estérel Classic	Mougins Classic	PMR	Génération Premium	Monte Carlo 3	Horizon Classic	Cap Ferrat Premium	Cap Ferrat Classic
Material	Thermoset	•	•	•	•	•	•	•					
	Thermoplastic								•	•			
	Composite wood											•	•
	MDF										•		
Fixing system	Plastic bar hinge + quick plastic screw									•			
	Individual hinge, stainless steel	•	•	•	•	•	•	•	•		metal	•	•
	Top fixing	•	•	•	•				•			•	•
Comfort	Soft close	•	•	•	•				•			•	
	Antibacterial	•	•	•	•	•	•	•				•	•
	Quick release	•	•	•	•				•			•	
Design	Sandwich	•		•	•	•	•	•	•	•	•	•	•
	Slim	•											
	Wrapover		•	•									
	D-shape		•										
Dimensions	Length (mm)	420 ~ 450	394 ~ 440	411 ~ 461	420 ~ 450	420 ~ 450	433 ~ 443	418 ~ 466	408 ~ 454	405 ~ 450	410 ~ 470	440 ~ 460	440 ~ 460
	Width (mm)	375	368	368	376	369	372	373	371	364	370	380	380
	Center distance WC (mm)	90 ~ 165	80 ~ 175	117 ~ 180	80 ~ 175	140 ~ 185	155	150 ~ 180	95 ~ 185	133 ~ 180	110 ~ 200	120 ~ 180	120 ~ 180
	Opening angle	120°	110°	110°	110°	110°	120°	120°	98°	98°	98°	98°	98°
Weight		2,2	2,5	2,1	2,3	1,6	1,5	2,4	1,9	1,4	2,8	2,8	2,8
Guarantee (years)		2	2	2	2	2	2	2	2	2	1	5	5

THERMOSET TOILET SEATS



AZUR PREMIUM SLIM

Thin profile

Extra flat design

- Oval shape
- Sandwich design
- **Soft close**
- **Quick release** for easy cleaning
- **Top fixing** for effortless installation
- **Adjustable stainless steel hinges**
- White
- 2.2 kg

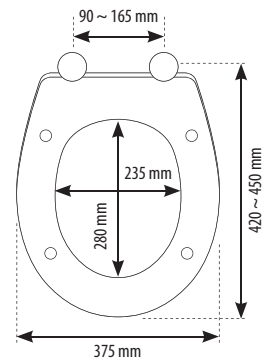

	Ref.	Barcode	Packing	Packing Nb	Packing Kg	Pallet quantity
AZUR PREMIUM SLIM	95 9007 10	3 24723 001072 1	Box	4	12.65	160



PRINCIPAUTÉ PREMIUM

Modern D-Shape

Flat and overlapping cover

- D-Shape
- Wrapover design
- **Soft close**
- **Quick release** for easy cleaning
- **Top fixing** for effortless installation
- **Adjustable stainless steel hinges**
- White
- 2.5 kg

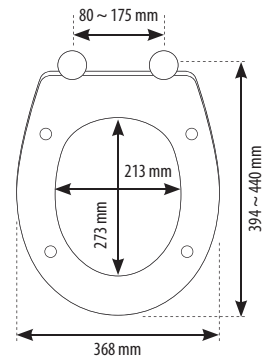

	Ref.	Barcode	Packing	Packing Nb	Packing Kg	Pallet quantity
PRINCIPAUTÉ PREMIUM	95 9001 10	3 24723 007641 3	Box	4	13.2	160



VENCE PREMIUM

Contemporary covering

Flat cover

- Oval shape
- Semi wrapover design
- **Soft close**
- **Quick release** for easy cleaning
- **Top fixing** for effortless installation
- **Adjustable stainless steel hinges**
- White
- 2.1 kg

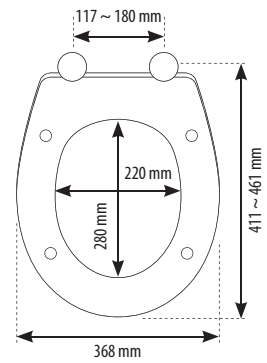

	Ref.	Barcode	Packing	Packing Nb	Packing Kg	Pallet quantity
VENCE PREMIUM	95 9005 10	3 24723 007645 1	Box	4	11.2	160



ESTÉREL PREMIUM

Concave shape

Curved design

- Oval shape
- Sandwich design
- **Soft close**
- **Quick release** for easy cleaning
- **Top fixing** for effortless installation
- **Adjustable stainless steel hinges**
- White
- 2.3 kg

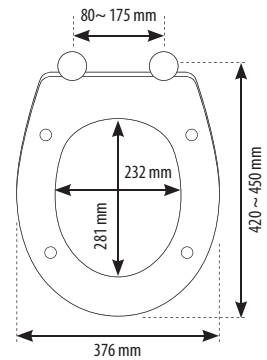

	Ref.	Barcode	Packing	Packing Nb	Packing Kg	Pallet quantity
ESTÉREL PREMIUM	95 9003 10	3 24723 007643 7	Box	7	19.5	168

THERMOSET TOILET SEATS



ESTÉREL CLASSIC

Suitable for intensive use

Robust

- Oval shape
- Sandwich design
- Bottom **fast fix**
- **Adjustable stainless steel hinges**
- White
- 1.6 kg

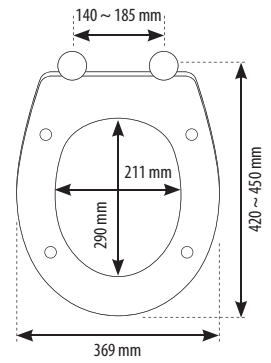

	Ref.	Barcode	Packing	Packing Nb	Packing Kg	Pallet quantity
ESTÉREL CLASSIC	95 9002 10	3 24723 007642 0	Box	4	9.2	160



MOUGINS CLASSIC

Standard thermoset

Ergonomical

- Oval shape
- Sandwich design
- Bottom **fast fix**
- **Stainless steel hinges**
- White
- 1.5 kg

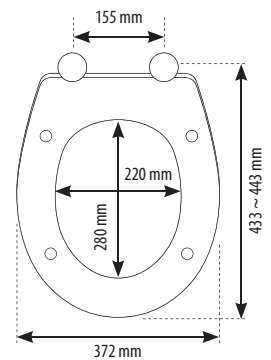

	Ref.	Barcode	Packing	Packing Nb	Packing Kg	Pallet quantity
MOUGINS CLASSIC	95 9012 10	3 24723 010210 5	Box	7	12.8	168

THERMOSET TOILET SEATS



PMR

Accessibility for all

Prevention of lateral movement
Reinforced fixation

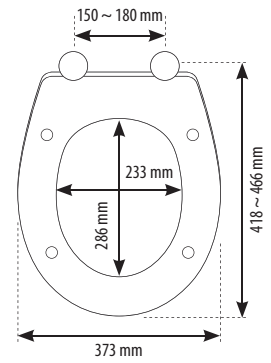

- Oval shape
- Sandwich design
- **Adjustable locating buffers for added stability**
- Bottom **fast fix**
- **Adjustable secure fix stainless steel hinges**
- White
- 2.4 kg

	Ref.	Barcode	Packing	Packing Nb	Packing Kg	Pallet quantity
PMR	95 8610 10	3 24723 008345 9	Box	4	10.9	160

THERMOPLASTIC TOILET SEATS



GÉNÉRATIONS PREMIUM

Adaptable for all the family

Integrated & removable
childrens seat

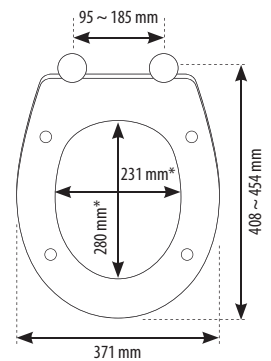

*for child: 150 x 205 mm

- Oval shape
- Sandwich design
- Magnetic stay secures childrens seat to the cover
- **Soft close**
- **Quick release** for easy cleaning
- **Top fixing** for easy installation
- **Adjustable stainless steel hinges**
- White
- 1.9 kg

	Ref.	Barcode	Packing	Packing Nb	Packing Kg	Pallet quantity
GÉNÉRATIONS PREMIUM	95 8223 10	3 24723 007665 9	Box	5	13.2	150

THERMOPLASTIC TOILET SEATS



White



MONTE CARLO 3

Choice of colours

Available in White, Manhattan grey, Dark grey, Raspberry, Plum, Taupe

- Oval shape
- Sandwich design
- Bottom fix
- Adjustable plastic bar hinge
- White
- 1.4kg

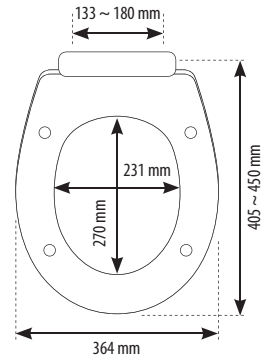

Manhattan Grey



Dark Grey



Raspberry



Plum

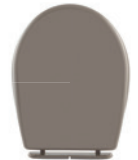

Taupe

	Ref.	Barcode	Packing	Packing Nb	Packing Kg	Pallet quantity
MONTE CARLO 3 WHITE	45 5251 18	3 24723 003557 1	Tray	10	17.89	160
MONTE CARLO 3 MANHATTAN GREY	45 5254 18 0096	3 24723 005374 2	Tray	3	5.55	108
MONTE CARLO 3 DARK GREY	45 5254 18 1480	3 24723 005188 5	Tray	3	5.55	108
MONTE CARLO 3 RASPBERRY	45 5254 18 6773	3 24723 005189 2	Tray	3	5.55	108
MONTE CARLO 3 PLUM	45 5254 18 0639	3 24723 005186 1	Tray	3	5.55	108
MONTE CARLO 3 TAUPE	45 5254 18 6056	3 24723 005190 8	Tray	3	5.55	108

MDF TOILET SEATS



HORIZON CLASSIC

Classic toilet seat

Large hinge adjustment range

- Oval shape
- Sandwich design
- **Anti-UV treatment**
- Bottom fix
- Metallic hinges
- White
- 2,8 kg

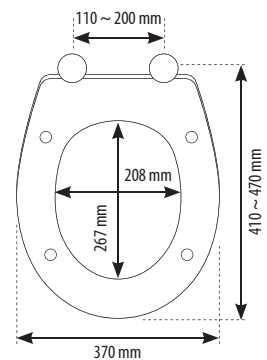

	Ref.	Barcode	Packing	Packing Nb	Packing Kg	Pallet quantity
HORIZON CLASSIC	95 8270 10	3 24723 008342 8	Box	1	3	144

COMPOSITE WOOD TOILET SEATS



CAP FERRAT PREMIUM

Robust luxury

Maximum resistance to moisture
Sensation of warmth

- Oval shape
- Sandwich design
- **Soft close**
- **Quick release** for easy cleaning
- **Top fixing** for easy installation
- **Adjustable stainless steel hinges**
- White
- 2.8 kg

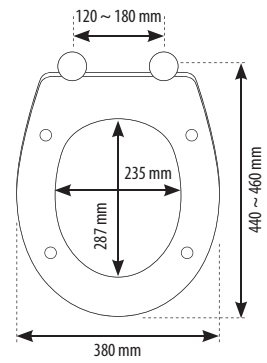

	Ref.	Barcode	Packing	Packing Nb	Packing Kg	Pallet quantity
CAP FERRAT PREMIUM	95 9501 10	3 24723 008739 6	Box	5	17.5	150

HIGHLY ROBUST MATERIAL

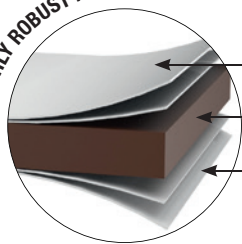

2 anti-bacterial lacquered coats

Homogeneous mix of different components: resin, wood and vegetable material - heated and pressed

2 anti-bacterial lacquered coats



CAP FERRAT CLASSIC

Robust and versatile

Maximum resistance to moisture
Sensation of warmth

- Oval shape
- Sandwich design
- **Top fixing** for easy installation
- **Adjustable stainless steel hinges**
- White
- 2.8 kg

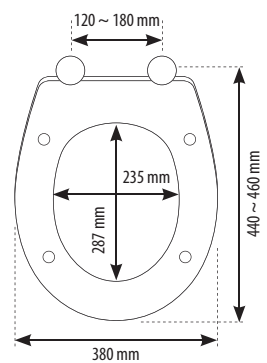

	Ref.	Barcode	Packing	Packing Nb	Packing Kg	Pallet quantity
CAP FERRAT CLASSIC	95 9500 10	3 24723 007672 7	Box	5	17.5	150



SIAMP

SIAMP Ltd,
Unit C2, Meadowbank Business Park,
Tweedale Way, Hollinwood
Oldham,
OL9 8EH

T: 0161 681 2120
F: 0161 681 2130

info@siamp.co.uk
www.siamp.co.uk