



 **KINDRED**

KITCHEN SINKS AND MORE

SHOWROOM PRICE GUIDE - FEBRUARY 2018

Kindred

Your home and everything in it is a reflection of you. From the comforts that are important to you and your family, to design preferences and layouts, and even the fixtures and fittings in the kitchen, all elements echo the unique aspects of your life. The kitchen is the center of the home, the heart. That's why we make Kindred sinks and accessories so easy on their owners.

Easy to choose
Easy to install
Easy to clean
Easy to love

Choose from Kindred's offering of stainless steel and color products, for topmount, dual mount or undermount installation, and complement your choice with some of our chore busting accessories. Durable, functional products, designed for living, in a variety of sizes, shapes and price points.

Every product is thoughtfully considered down to the smallest detail, to ensure that your selection is both practical and beautiful. And we stand behind our products with industry certifications, and solid product warranties.

We appreciate your interest in our products and invite you to explore the many Kindred options for the heart of your home. Thank you!

KITCHEN SINKS AND MORE 





KINDRED STYLE.

Function, finish and fittings ...

A SINK SERVES ONE KEY FUNCTION ... TO WASH UP. PLAIN AND SIMPLE.

However, with consideration for bowl configuration, material, finish and a few key accessories, the kitchen sink can be anything but mundane – it can be key to simplifying tasks in the kitchen.

Consider how you use your sink. Do you wash and stack, or simply rinse before loading the dishwasher? How about food prep? You may want one large bowl for cleanup of serving trays and roasters, with a second separate sink for a prep station or hospitality area. We have sinks for all of these and more!

The décor of your home and choice of appliances and cabinetry hardware finishes may also influence your selection of a particular finish in a sink. Commercial satin is a lovely complement to commercial look appliances, whereas granite composite products with matching faucets are a nice alternative to stainless.

A sink is just a sink ... until you add chore busting accessories! Chopping boards for slicing and serving, colanders for rinsing, and racks for draining are just some of the many sink accessories we offer to add function to your sink, and simplify your life. Add a dual spray kitchen faucet and matching soap dispenser, and your sink is transformed to a hub of kitchen efficiency!



Table of Contents

KINDRED COLLECTION DESIGNER SERIES HAND-CRAFTED	
Apron Front	04 - 05
Undermount and trough	06 - 09
Accessory rail sinks	10 - 12
KINDRED COLLECTION - STAINLESS	
Undermount	16 - 20
Vanity	22 - 25
KINDRED SANITIZED® GRANITE	
Topmount	28 - 29
Undermount	29 - 31
Color matched Granite faucets and soap dispensers	65 & 67
STEEL QUEEN	
Hand Fabricated	
Dual Mount	35 - 38
Apron Front	36
Undermount	39 - 40
Topmount	41 - 46
Cuisinette accessorized sinks	47 - 49
Undermount	50 - 56
Laundry and Hospitality	57 - 61
KINDRED FAUCETS / FITTINGS AND FOOD WASTE DISPOSERS	
Pull-out and pull-down faucets	64 - 66
Soap dispensers	67
Food waste disposers	68 - 69
KINDRED ACCESSORIES	
.....	72 - 76
FINISH NOTES	
.....	76
KINDRED WARRANTIES	
.....	76
QUICK FIND GUIDE	
.....	77 - 78



Sink model KCFD36B/9-10BG shown with faucet model KF10A.

K I N D R E D C O L L E C T I O N

Kindred Collection includes three families of product:

Designer Series

Hand crafted kitchen sinks in heavy 18 ga stainless steel, with sleek, but easy to clean 10 mm corners, and a commercial satin finish. Look for Apron Front sinks, Topmount sinks with integrated accessory rails, and Undermount models in a variety of sizes and bowl combinations to suit most every space. These models are **big, deep, quiet, beautiful and robust**. And many of the models include accessories!

Undermount

Kindred Collection 18 gauge undermount sinks feature big, generous dimensions, and distinctive creased bottom bowls, in an **array of sizes for kitchen, bar, island and vanity**.

Sanitized® Granite

Kindred Granite is simply gorgeous ... and tough! Available in **five fabulous sublime colors**, Kindred Granite topmount and undermount models are shipped complete with stainless steel bottom grids, and are a particularly striking choice when combined with a color-matched Kindred faucet.

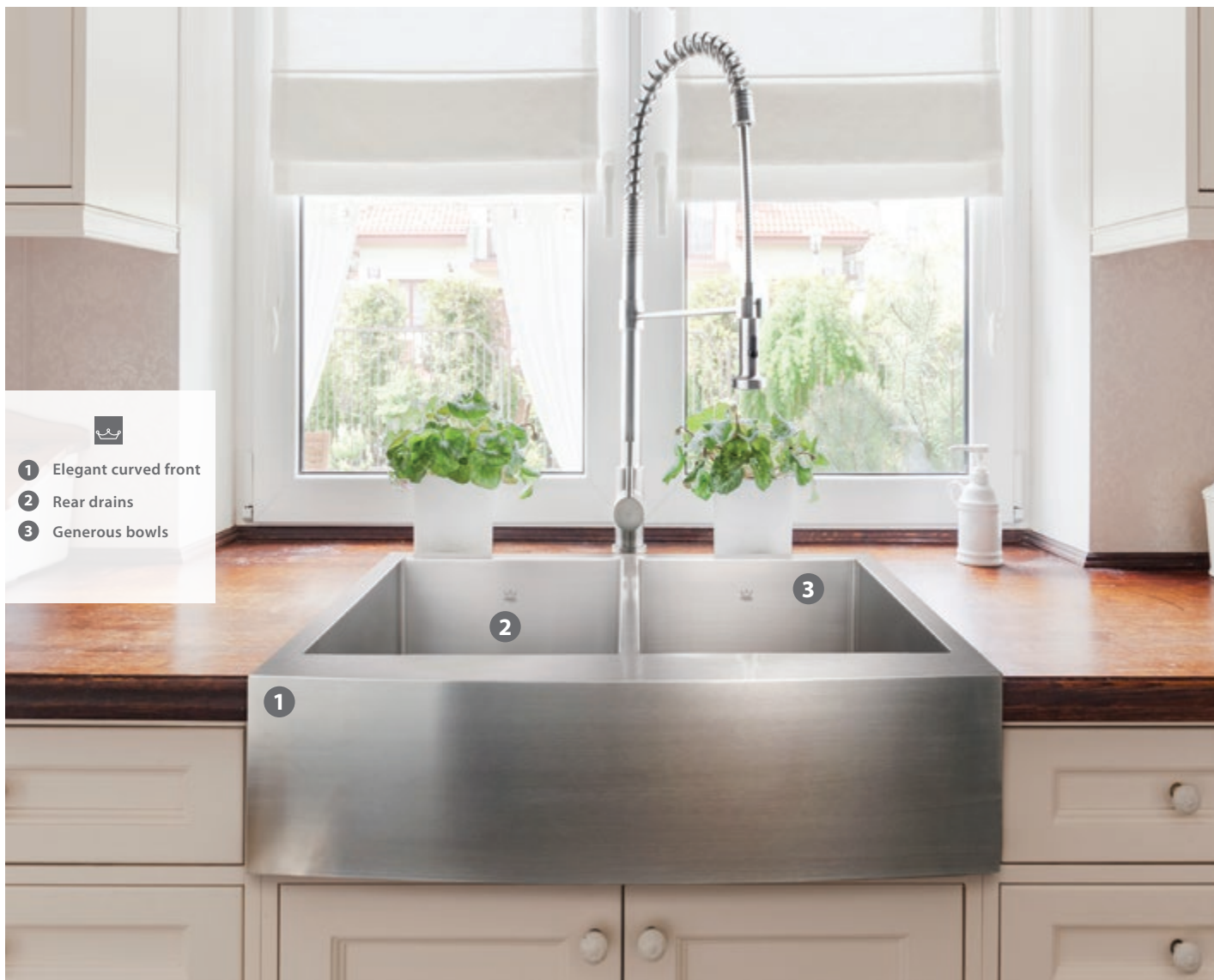

Sink model KFD36B/9-10BG shown with faucet model KF10B.

Designer Series Apron Front Sinks

HAND CRAFTED BEAUTY FOR YOUR HOME

When traditional styling calls out to you, but modern materials meet your lifestyle, consider a stainless steel Apron Front sink for old world charm and convenience for upkeep. Beautiful, big bowls will hold the biggest pots and platters in your pantry, and the curved expanse of the stainless steel apron will stand out as a showpiece in your kitchen. Kindred Designer Series apron front sinks may be installed flush to the countertop, undermount in a solid surface material, or for a truly unique profile, raised slightly above the countertop surface. Spectacular!

Cleverly designed with rear drains for more storage below, and with a sink bowl that is closer to the front of the apron for comfort, Kindred Designer Series apron front sinks feature a hardy commercial satin finish inside and out and easy to clean **10 mm bowl corners**. And we also include waste fittings and a bottom grid with every model for a sink that can handle whatever your busy home can dish out!



KCFS30B/10-10BG

\$1,749.00

10 mm radius covered corners

UPC® Shipping Weight 56.0 lbs. (25.5 kg.)

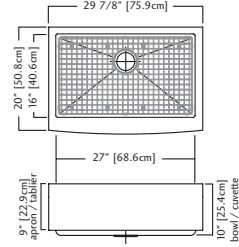

Outside sink rim dimensions 20" FB x 29 7/8" LR
Single bowl dimensions 16" FB x 27" LR x 10" DP

Bow front

Rear drain wastehole location
Bowl is pitched to the center of the wastehole
9" curved apron front

Undermount template included

FUN# 123.0178.912

30" cabinet - recommended minimum

OPTIONAL ACCESSORIES

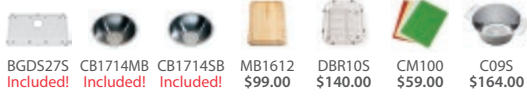

BGDS275 Included! CB1714MB Included! CB1714SB Included! MB1612 \$99.00 DBR105 \$140.00 CM100 \$59.00 C095 \$164.00

SUGGESTED KINDRED FITTINGS



KF10A \$509.00 KSD10A \$134.00

Speak to a showroom associate to determine correct hole drillings

KCFS33B/10-10BG

\$1,949.00

10 mm radius covered corners

UPC® Shipping Weight 61.0 lbs. (27.7 kg.)

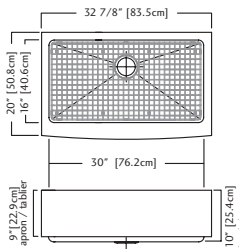

Outside sink rim dimensions 20" FB x 32 7/8" LR
Single bowl dimensions 16" FB x 30" LR x 10" DP

Bow front

Rear drain wastehole location
Bowl is pitched to the center of the wastehole
9" curved apron front

Undermount template included

FUN# 123.0178.915

33" cabinet - recommended minimum

OPTIONAL ACCESSORIES

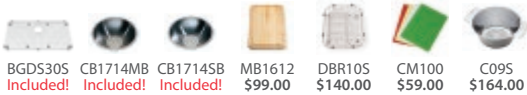

BGDS305 Included! CB1714MB Included! CB1714SB Included! MB1612 \$99.00 DBR105 \$140.00 CM100 \$59.00 C095 \$164.00

SUGGESTED KINDRED FITTINGS

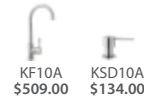

KF10A \$509.00 KSD10A \$134.00

Speak to a showroom associate to determine correct hole drillings

KCFS36B/10-10BG

\$2,079.00

10 mm radius covered corners

UPC® Shipping Weight 72.0 lbs. (32.8 kg.)

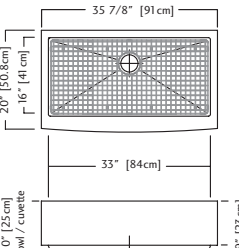

Outside sink rim dimensions 20" FB x 35 7/8" LR
Single bowl dimensions 16" FB x 33" LR x 10" DP

Bow front

Rear drain wastehole location
Bowl is pitched to the center of the wastehole
9" curved apron front

Undermount template included

FUN# 123.0055.590

36" cabinet - recommended minimum

OPTIONAL ACCESSORIES

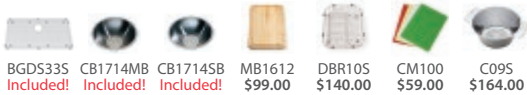

BGDS335 Included! CB1714MB Included! CB1714SB Included! MB1612 \$99.00 DBR105 \$140.00 CM100 \$59.00 C095 \$164.00

SUGGESTED KINDRED FITTINGS

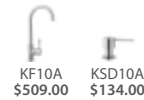

KF10A \$509.00 KSD10A \$134.00

Speak to a showroom associate to determine correct hole drillings

KCFD36B/9-10BG

\$2,699.00

10 mm radius covered corners

UPC® Shipping Weight 70.8 lbs. (32.3 kg.)

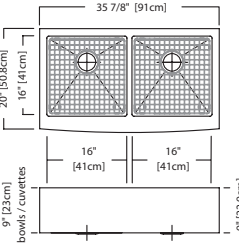

Outside sink rim dimensions 20" FB x 35 7/8" LR
Equal size bowl dimensions 16" FB x 16" LR x 9" DP

Bow front

Rear drain wastehole locations
Bowls are pitched to the center of the wasteholes
9" curved apron front

Undermount template included

FUN# 123.0055.615

36" cabinet - recommended minimum

OPTIONAL ACCESSORIES

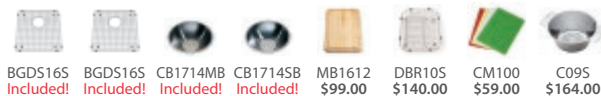

BGDS165 Included! BGDS16S Included! CB1714MB Included! CB1714SB Included! MB1612 \$99.00 DBR105 \$140.00 CM100 \$59.00 C095 \$164.00

SUGGESTED KINDRED FITTINGS



KF10A \$509.00 KSD10A \$134.00

Speak to a showroom associate to determine correct hole drillings



- 1 Smooth single handle operation
- 2 Easy to clean 10 mm corners
- 3 Rear drains for more storage below
- 4 Hand fabricated luxury

Sink model KCUC33R/9-10BG shown with faucet model KF10A and soap dispenser KSD10A.

Designer Series Undermount Sinks

A CLEAN SWEEP IN STREAMLINED BEAUTY

The chameleon of sinks, an undermount model works with most any decor, and is a natural choice when your countertop selection is a solid surface material. Kindred Designer Series undermount sinks are hand fabricated from heavy 18 ga stainless, with a robust commercial satin finish. And with sound dampening and undercoating on the underside, these big beauties are quiet even when full!

Choose from sizes and models for a wide range of standard cabinet sizes, and be delighted to discover that your sink not only **includes waste fittings**, but also a **stainless steel bottom grid** to help out with food prep or air drying dishes.

Robust materials, easy to clean, complete with accessories - what's not to love?!



DESIGNER SERIES • UNDERMOUNT SINKS • 18 GAUGE, 18-10 STAINLESS STEEL • BOTTOM GRID INCLUDED

KCUS21A/8-10BG

\$839.00



10 mm radius coved corners

UPC® Shipping Weight 25.64 lbs. (11.4 kg.)

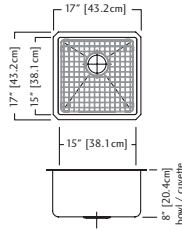

Outside sink rim dimensions 17" FB x 17" LR
Single bowl dimensions 15" FB x 15" LR x 8" DP

Rear drain wastehole location
Bowl is pitched to the center of the wastehole
Undermount template included

FUN# 123.0178.906

18" cabinet - recommended minimum

OPTIONAL ACCESSORIES

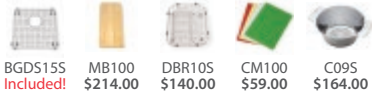

SUGGESTED KINDRED FITTINGS



KCUS24A/9-10BG

\$1,219.00



10 mm radius coved corners

UPC® Shipping Weight 36.0 lbs. (16.4 kg.)

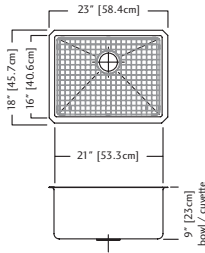

Outside sink rim dimensions 18" FB x 23" LR
Single bowl dimensions 16" FB x 21" LR x 9" DP

Rear drain wastehole location
Bowl is pitched to the center of the wastehole
Undermount template included

FUN# 123.0178.907

24" cabinet - recommended minimum

OPTIONAL ACCESSORIES



SUGGESTED KINDRED FITTINGS



KCUS30A/9-10BG

\$1,269.00



10 mm radius coved corners

UPC® Shipping Weight 48.6 lbs. (22.0 kg.)

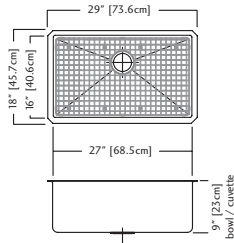

Outside sink rim dimensions 18" FB x 29" LR
Single bowl dimensions 16" FB x 27" LR x 9" DP

Rear drain wastehole location
Bowl is pitched to the center of the wastehole
Undermount template included

FUN# 123.0178.908

30" cabinet - recommended minimum

OPTIONAL ACCESSORIES



SUGGESTED KINDRED FITTINGS



KCUS33A/9-10BG

\$1,359.00



10 mm radius coved corners

UPC® Shipping Weight 41.4 lbs. (18.8 kg.)

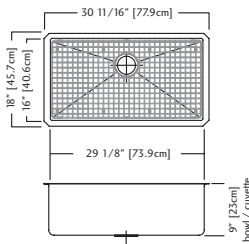

Outside sink rim dimensions 18" FB x 30 11/16" LR
Single bowl dimensions 16" FB x 29 1/8" LR x 9" DP

Rear drain wastehole location
Bowl is pitched to the center of the wastehole
Undermount template included

FUN# 123.0178.909

33" cabinet - recommended minimum

OPTIONAL ACCESSORIES



SUGGESTED KINDRED FITTINGS



DESIGNER SERIES • UNDERMOUNT SINKS • 18 GAUGE, 18-10 STAINLESS STEEL • BOTTOM GRID INCLUDED

KCUD30/9-10BG

\$1,799.00

cUPC® Shipping Weight 47.0 lbs. (21.4 kg.)

Outside sink rim dimensions 18" FB x 29" LR
Equal size bowl dimensions 16" FB x 13" LR x 9" DP
Rear drain wastehole locations
Bowls are pitched to the center of the wastehole
Undermount template included

FUN# 123.0078.543

30" cabinet - recommended minimum

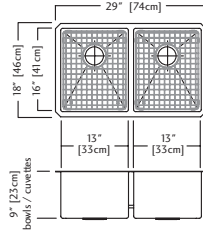

OPTIONAL ACCESSORIES



SUGGESTED KINDRED FITTINGS



KCUD33/9-10BG

\$1,989.00

cUPC® Shipping Weight 49.25 lbs. (22.0 kg.)

Outside sink rim dimensions 18" FB x 31" LR
Equal size bowl dimensions 16" FB x 14" LR x 9" DP
Rear drain wastehole locations
Bowls are pitched to the center of the wastehole
Undermount template included

FUN# 123.0078.550

33" cabinet - recommended minimum

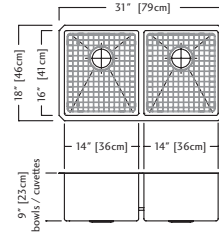

OPTIONAL ACCESSORIES



SUGGESTED KINDRED FITTINGS

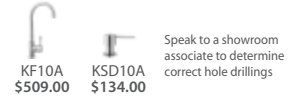

KCUD36/9-10BG

\$2,089.00

cUPC® Shipping Weight 46.85 lbs. (20.9 kg.)

Outside sink rim dimensions 18" FB x 35" LR
Equal size bowl dimensions 16" FB x 16" LR x 9" DP
Rear drain wastehole locations
Bowls are pitched to the center of the wastehole
Undermount template included

FUN# 123.0055.624

36" cabinet - recommended minimum

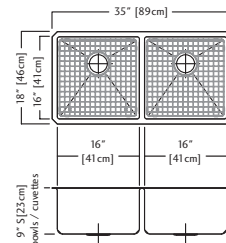

OPTIONAL ACCESSORIES



SUGGESTED KINDRED FITTINGS



KCUC27R/9-10BG

\$1,539.00

cUPC® Shipping Weight 40.0 lbs. (18.2 kg.)

Outside sink rim dimensions 18" FB x 26" LR
Large bowl dimensions 16" FB x 13" LR x 9" DP
Small bowl dimensions 16" FB x 10" LR x 8" DP
Rear drain wastehole locations
Bowls are pitched to the center of the wastehole
Undermount template included

FUN# 123.0178.910

27" cabinet - recommended minimum

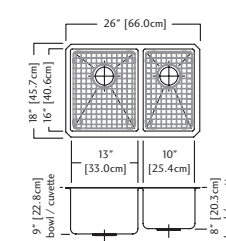

OPTIONAL ACCESSORIES



SUGGESTED KINDRED FITTINGS

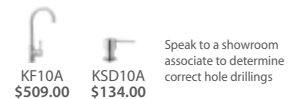

DESIGNER SERIES • UNDERMOUNT SINKS • 18 GAUGE, 18-10 STAINLESS STEEL • BOTTOM GRID INCLUDED

KCUC33R/9-10BG

\$1,859.00

10 mm radius coved corners
 UPC® Shipping Weight 51.0 lbs. (21.2 kg.)

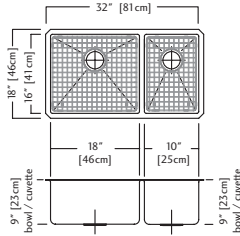

Outside sink rim dimensions 18" FB x 32" LR
 Large bowl dimensions 16" FB x 18" LR x 9" DP
 Small bowl dimensions 16" FB x 11" LR x 9" DP

Rear drain wastehole locations
 Bowls are pitched to the center of the wastehole
Undermount template included

FUN# 123.0055.594

33" cabinet - recommended minimum

OPTIONAL ACCESSORIES



BGDS115 **Included!** BGDS185 **Included!** MB100 \$214.00 DBR10S \$140.00 CM100 \$59.00 C095 \$164.00

SUGGESTED KINDRED FITTINGS

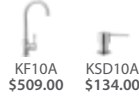

KF10A \$509.00 KSD10A \$134.00 Speak to a showroom associate to determine correct hole drillings

KCUC36R/9-10BG

\$2,229.00

10 mm radius coved corners
 UPC® Shipping Weight 46.0 lbs. (20.9 kg.)

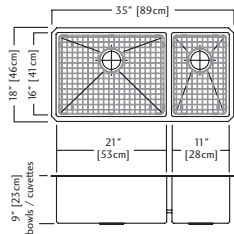

Outside sink rim dimensions 18" FB x 35" LR
 Large bowl dimensions 16" FB x 21" LR x 9" DP
 Small bowl dimensions 16" FB x 11" LR x 9" DP

Rear drain wastehole locations
 Bowls are pitched to the center of the wastehole
Undermount template included

FUN# 123.0151.502

36" cabinet - recommended minimum

OPTIONAL ACCESSORIES



BGDS115 **Included!** BGDS21S **Included!** MB100 \$214.00 DBR10S \$140.00 CM100 \$59.00 C095 \$164.00

SUGGESTED KINDRED FITTINGS



KF10A \$509.00 KSD10A \$134.00 Speak to a showroom associate to determine correct hole drillings

KCUS8A/8-10BG

\$559.00

10 mm radius coved corners
 UPC® Shipping Weight 21.15 lbs. (9.4 kg.)

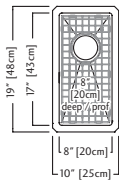

Outside sink rim dimensions 19" FB x 10" LR
 Single bowl dimensions 17" FB x 8" LR x 8" DP

Rear drain wastehole location
 Bowl is pitched to the center of the wastehole
Undermount template included

FUN# 122.0275.251

18" cabinet - recommended minimum

OPTIONAL ACCESSORIES



BGDS0817S **Included!**

SUGGESTED KINDRED FITTINGS

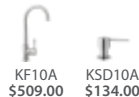

KF10A \$509.00 KSD10A \$134.00 Speak to a showroom associate to determine correct hole drillings

KCUS22A/8-10BG

\$679.00

10 mm radius coved corners
 UPC® Shipping Weight 25.35 lbs. (11.3 kg.)

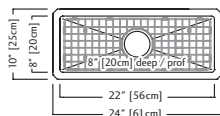

Outside sink rim dimensions 10" FB x 24" LR
 Single bowl dimensions 8" FB x 22" LR x 8" DP

Rear drain wastehole location
 Bowl is pitched to the center of the wastehole
Undermount template included

FUN# 122.0275.252

24" cabinet - recommended minimum

OPTIONAL ACCESSORIES



BGDS22S **Included!**

SUGGESTED KINDRED FITTINGS



KF10A \$509.00 KSD10A \$134.00 Speak to a showroom associate to determine correct hole drillings



Sink model KCC30R/9-10A shown with C09S colander, DBR10S drain rack and KF10A faucet.

Designer Series Accessory Rail Sinks

INNOVATIVE DESIGN

At Kindred we never stop experimenting with the latest materials and technology and exploring innovative ideas and designs to bring the world's best sink selection to you.

Our Designer Series Accessory Rail kitchen sinks are fabricated from heavy 18 gauge stainless steel with generous 9 inch deep bowls, boast a sleek rim and profile with 10 mm radius corners, and an integrated accessory rail. These models do double duty and save space, by allowing placement of drainer baskets, colanders and cutting boards right on the sink for food prep and clean up. All Designer Series Accessory Rail models are shipped **complete with a stainless steel bottom grid, glass board/color mat, and stainless steel colander.**

As with all Designer Series models, we have finished our topmount and undermount sinks with a commercial #4 satin finish, a perfect complement to commercial look appliances, and easy to repair should you scratch it.

DESIGNER SERIES • TOPMOUNT ACCESSORY RAIL SINKS • 18 GAUGE, 18-10 STAINLESS STEEL

KCD36/9-10A

\$2,199.00



10 mm radius covered corners

Shipping Weight 56.0 lbs. (25.4 kg)

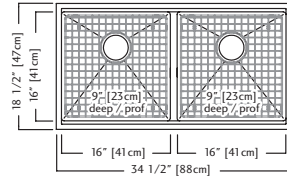

Outside sink rim dimensions 18 1/2" FB x 34 1/2" LR
Equal size bowl dimensions 16" FB x 16" LR x 9" DP

Rear drain wastehole locations
Bowls are pitched to the center of the wastehole

FUN# 123.0202.224

36" cabinet - recommended minimum

OPTIONAL ACCESSORIES

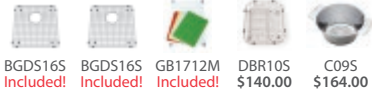

BGDS165 Included! BGDS165 Included! GB1712M Included! DBR105 \$140.00 C09S \$164.00

SUGGESTED KINDRED FITTINGS



Speak to a showroom associate to determine correct hole drillings

KCD33/9-10A

\$2,089.00



10 mm radius covered corners

Shipping Weight 52.0 lbs. (23.6 kg)

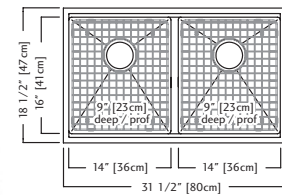

Outside sink rim dimensions 18 1/2" FB x 30 1/2" LR
Equal size bowl dimensions 16" FB x 14" LR x 9" DP

Rear drain wastehole locations
Bowls are pitched to the center of the wastehole

FUN# 123.0202.222

33" cabinet - recommended minimum

OPTIONAL ACCESSORIES

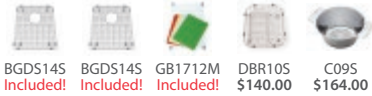

BGDS145 Included! BGDS145 Included! GB1712M Included! DBR105 \$140.00 C09S \$164.00

SUGGESTED KINDRED FITTINGS



Speak to a showroom associate to determine correct hole drillings

KCC33R/9-10A

\$1,949.00



10 mm radius covered corners

Shipping Weight 53.0 lbs. (24.0 kg)

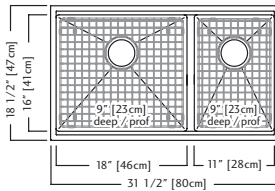

Outside sink rim dimensions 18 1/2" FB x 31 1/2" LR
Large bowl dimensions 16" FB x 18" LR x 9" DP
Small bowl dimensions 16" FB x 11" LR x 9" DP

Rear drain wastehole locations
Bowls are pitched to the center of the wastehole

FUN# 123.0202.236

33" cabinet - recommended minimum

OPTIONAL ACCESSORIES

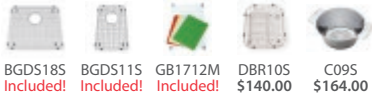

BGDS185 Included! BGDS115 Included! GB1712M Included! DBR105 \$140.00 C09S \$164.00

SUGGESTED KINDRED FITTINGS

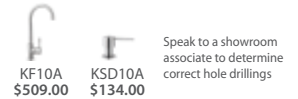

Speak to a showroom associate to determine correct hole drillings

KCS30/10-10A

\$1,329.00



10 mm radius covered corners

Shipping Weight 48.0 lbs. (21.8 kg)

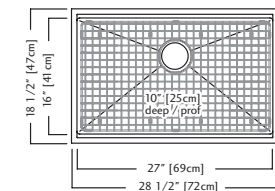

Outside sink rim dimensions 18 1/2" FB x 28 1/2" LR
Single bowl dimensions 16" FB x 27" LR x 10" DP

Rear drain wastehole locations
Bowls are pitched to the center of the wastehole

FUN# 123.0202.228

30" cabinet - recommended minimum

OPTIONAL ACCESSORIES

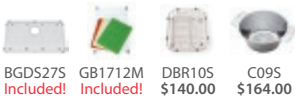

BGDS275 Included! GB1712M Included! DBR105 \$140.00 C09S \$164.00

SUGGESTED KINDRED FITTINGS

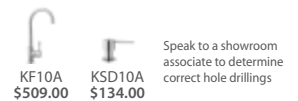

Speak to a showroom associate to determine correct hole drillings

DESIGNER SERIES • TOPMOUNT ACCESSORY RAIL SINKS • 18 GAUGE, 18-10 STAINLESS STEEL

KCS33/10-10A

\$1,419.00

UPC®

10 mm radius coved corners
Shipping Weight 52.0 lbs. (23.6 kg.)

Outside sink rim dimensions 18 1/2" FB x 28 1/2" LR
Single bowl dimensions 16" FB x 30" LR x 10" DP
Rear drain wastehole locations
Bowls are pitched to the center of the wastehole

FUN# 123.0202.230
33" cabinet - recommended minimum

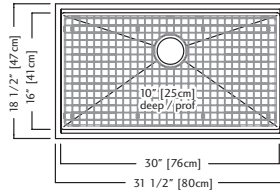

OPTIONAL ACCESSORIES

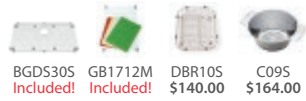

SUGGESTED KINDRED FITTINGS



KCS21SR/8-10BG

\$999.00

UPC®

10 mm radius coved corners
Shipping Weight 31.0 lbs. (14.0 kg.)

Outside sink rim dimensions 17" FB x 17 1/2" LR
Single bowl dimensions 15" FB x 15" LR x 8" DP
Rear drain wastehole locations
Bowls are pitched to the center of the wastehole

FUN# 123.0202.234
21" cabinet - recommended minimum

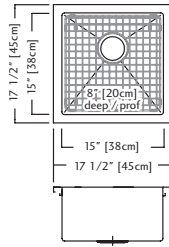

OPTIONAL ACCESSORIES

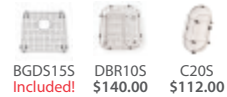

SUGGESTED KINDRED FITTINGS





DESIGNED TO INSPIRE

Hand fabricated in heavy 18 ga stainless to exacting quality standards, and shipped complete with waste fittings and installation templates, Kindred Designer Series sinks are designed to inspire you in the creation of your dream kitchen. We offer a wide range of sizes suitable to standard cabinets, and include chore busting accessories and waste fittings with every single model.

Whether you choose a statuesque apron front model, an undermount model, or a model with a slim integrated accessory rail, a Kindred Designer Series sink will be a wonderful centerpiece in your home, and a joy to use for years to come.

Easy to choose Easy to use Easy to love



- ① Aerated stream & spray flow
- ② Radiant silk rim and bowls
- ③ 18 ga stainless steel

1

2

3

Sink model KSS6UA/9D shown with BGAS2317S bottom grid, KFPD1150 faucet and soap dispenser KSD150.

KINDRED COLLECTION

Why Kindred?

Kindred Collection undermount stainless steel sinks offer affordable luxury in a variety of sizes and configurations, for most any kitchen or powder room. Single bowl, double, triple and combos for kitchen. And for the powder room, stainless steel round, ovals and even rectangular bowls for a truly striking oasis.

Designed to be installed by a professional into a solid surface countertop, Kindred Collection undermount sinks are manufactured from heavy 18 gauge stainless steel, and finished in lustrous radiant sink on the rim and in the bowls. In using 18 gauge stainless, we can manufacture a very deep sink, with tight radius corners - allowing you a sleek profile in a sink with super capacity for those big clean up jobs! An 18 gauge sink also means a quiet sink when in use. And after all, who doesn't appreciate the strong, silent type?!

What is a radiant silk finish? We're glad you asked! Our proprietary radiant silk finish actually starts off bright and shiny, and is then processed with unique buffing methods to produce a hard wearing lustre that is still bright, but easy to repair should you happen to scratch it.

So Kindred Collection undermount products are heavy, and beautifully finished. **But what else makes them so special?** We like to include waste fittings with our products, so you don't have to purchase them separately, and the same applies to cutout templates! And we have a preference to place our drains towards the back of the sink bowl, giving you more room below for storage - simple idea, but very useful! **We're not done yet** ... before we pack our sinks we apply sound deadening pads, and also undercoating, which acts to reduce condensation on the underside of the sink, and also enhances the sound insulation.

The thought we take, and the features we build into our Kindred Collection sinks are all with you in mind, to ensure that your sink is ...

Easy to choose Easy to use Easy to love



Sink model KSS7UA/9D with BGA3117S bottom grid.

Kindred Undermount Series

VALUE IS GOOD...

Take a look at Kindred Collection Undermount Series and see if you don't agree ...

- 9" deep bowls are deep enough to contain any water splashing
- Silk finish sink bowls and sink deck are warm in appearance and easy to maintain
- Heavy 18 gauge and high Nickel 18/10 stainless steel ... make for a superior quality product
- Tight radius bowl corners increase sink bowl capacity
- **Bottom grid included with most kitchen sink models**
- Straight clean bowl shapes, and sink bowl drain lines, complement the very popular commercial kitchen of today
- Optional accessories simplify meal preparation

We hope that you agree.

KINDRED COLLECTION · UNDERMOUNT SERIES · 18 GAUGE, 18-10 STAINLESS STEEL

KSD1UA/9D

\$1,049.00



Undermount model

Shipping Weight 23.1 lbs. (10.5 kg.)

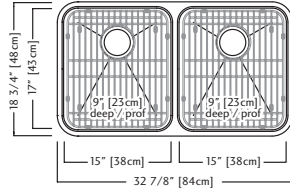

Outside sink rim dimensions 18 3/4" FB x 32 7/8" LR
Equal size bowl dimensions 17" FB x 15" LR x 9" DP

Rear drain wastehole locations

FUN# 122.0183.144

36" cabinet - recommended minimum

OPTIONAL ACCESSORIES

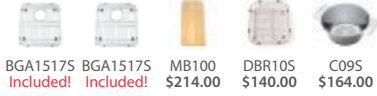

SUGGESTED KINDRED FITTINGS



KSD2UA/9D

\$919.00



Undermount model

Shipping Weight 23.1 lbs. (10.5 kg.)

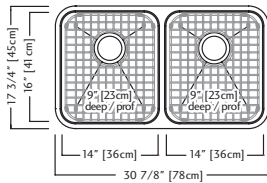

Outside sink rim dimensions 17 3/4" FB x 30 7/8" LR
Equal size bowl dimensions 16" FB x 14" LR x 9" DP

Rear drain wastehole locations

FUN# 122.0183.146

33" cabinet - recommended minimum

OPTIONAL ACCESSORIES

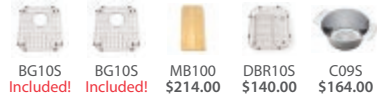

SUGGESTED KINDRED FITTINGS



KSDCRU/9

\$1,059.00



Undermount model

Shipping Weight 26.0 lbs. (11.8 kg.)

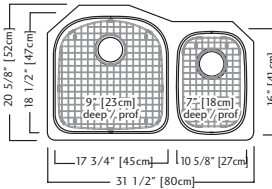

Outside sink rim dimensions 20 5/8" FB x 31 1/2" LR
Large bowl dimensions 18 1/2" FB x 17 3/4" LR x 9" DP
Small bowl dimensions 16" FB x 10 5/8" LR x 7" DP

Rear drain wastehole locations

FUN# 122.0045.000

33" cabinet - recommended minimum

OPTIONAL ACCESSORIES

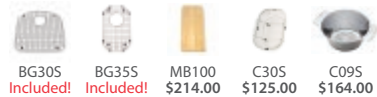

SUGGESTED KINDRED FITTINGS



KSCM3RUA/9D

\$989.00



Undermount model

Shipping Weight 31.2 lbs. (14.2 kg.)

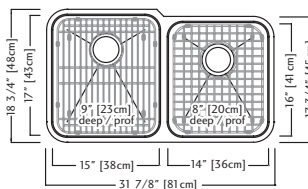

Outside sink rim dimensions 18 3/4" FB x 31 7/8" LR
Large bowl dimensions 17" FB x 15" LR x 9" DP
Small bowl dimensions 16" FB x 14" LR x 8" DP

Rear drain wastehole locations

FUN# 122.0183.150

33" cabinet - recommended minimum

OPTIONAL ACCESSORIES

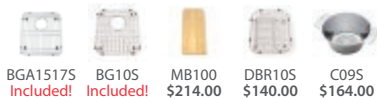

SUGGESTED KINDRED FITTINGS

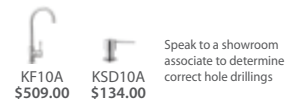

KINDRED COLLECTION • UNDERMOUNT SERIES • 18 GAUGE, 18-10 STAINLESS STEEL

KSC1RUA/9D

\$1,179.00



Undermount model

Shipping Weight 18.8 lbs. (8.5 kg.)

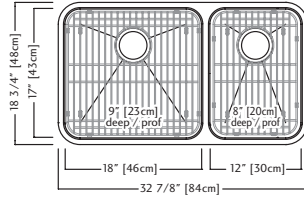

Outside sink rim dimensions 18 3/4" FB x 32 7/8" LR
Large bowl dimensions 17" FB x 18" LR x 9" DP
Small bowl dimensions 17" FB x 12" LR x 8" DP

Rear drain wastehole locations

FUN# 122.0183.153

33" cabinet - recommended minimum

OPTIONAL ACCESSORIES

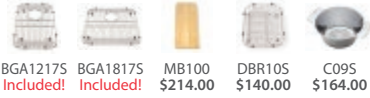

SUGGESTED KINDRED FITTINGS



KSC2RUA/9D

\$919.00



Undermount model

Shipping Weight 19.9 lbs. (9.0 kg.)

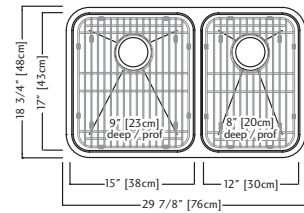

Outside sink rim dimensions 18 3/4" FB x 29 7/8" LR
Large bowl dimensions 17" FB x 15" LR x 9" DP
Small bowl dimensions 17" FB x 12" LR x 8" DP

Rear drain wastehole locations

FUN# 122.0183.155

30" cabinet - recommended minimum

OPTIONAL ACCESSORIES

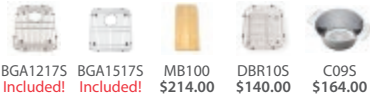

SUGGESTED KINDRED FITTINGS



KSCM1RUA/9D

\$1,419.00



Undermount model

Shipping Weight 33.0 lbs. (15.0 kg.)

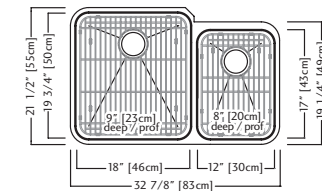

Outside sink rim dimensions 21 1/2" FB x 32 7/8" LR
Large bowl dimensions 19 3/4" FB x 18" LR x 9" DP
Small bowl dimensions 17" FB x 12" LR x 8" DP

Rear drain wastehole locations

FUN# 122.0183.157

24" x 36" cabinet - recommended minimum

OPTIONAL ACCESSORIES

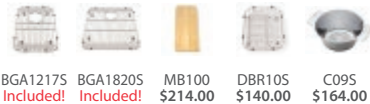

SUGGESTED KINDRED FITTINGS



KSS6UA/9D

\$709.00



Undermount model

Shipping Weight 14.8 lbs. (6.7 kg.)

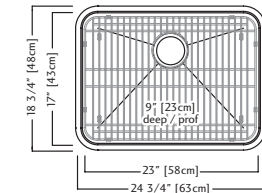

Outside sink rim dimensions 18 3/4" FB x 24 3/4" LR
Single bowl dimensions 17" FB x 23" LR x 9" DP

Rear drain wastehole location

FUN# 122.0183.160

27" cabinet - recommended minimum

OPTIONAL ACCESSORIES



SUGGESTED KINDRED FITTINGS

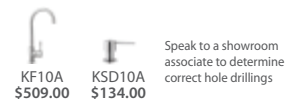

KINDRED COLLECTION • UNDERMOUNT SERIES • 18 GAUGE, 18-10 STAINLESS STEEL

KSS5UA/9D

\$749.00

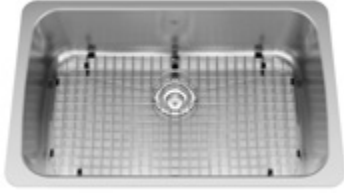

Undermount model

Shipping Weight 26.3 lbs. (11.9 kg.)

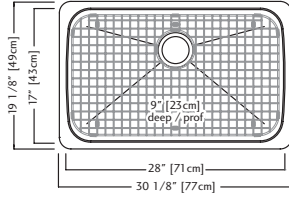

Outside sink rim dimensions 19 1/8" FB x 30 1/8" LR
Single bowl dimensions 17" FB x 28" LR x 9" DP

Rear drain wastehole location

FUN# 122.0183.161

30" cabinet - recommended minimum

OPTIONAL ACCESSORIES

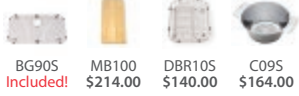

SUGGESTED KINDRED FITTINGS



KSS7UA/9D

\$759.00

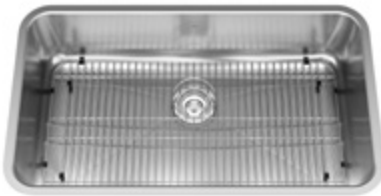

Undermount model

Shipping Weight 35. lbs. (15.9 kg.)

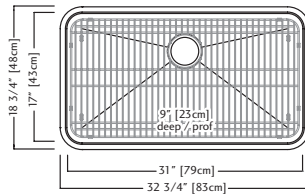

Outside sink rim dimensions 18 3/4" FB x 32 3/4" LR
Single bowl dimensions 17" FB x 31" LR x 9" DP

Rear drain wastehole location

FUN# 122.0183.162

33" cabinet - recommended minimum

OPTIONAL ACCESSORIES



SUGGESTED KINDRED FITTINGS



KSS4UA/9D

\$619.00



Undermount model

Shipping Weight 9.9 lbs. (4.5 kg.)

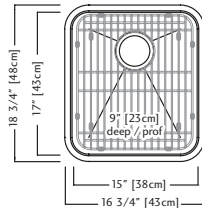

Outside sink rim dimensions 18 3/4" FB x 16 3/4" LR
Single bowl dimensions 17" FB x 15" LR x 9" DP

Rear drain wastehole location

FUN# 122.0183.165

18" cabinet - recommended minimum

OPTIONAL ACCESSORIES



SUGGESTED KINDRED FITTINGS

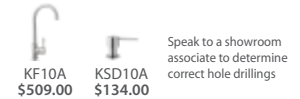

KSS8UA/8D

\$599.00



Undermount model

Shipping Weight 13.2 lbs. (6.0 kg.)

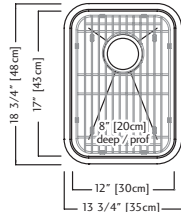

Outside sink rim dimensions 18 3/4" FB x 13 3/4" LR
Single bowl dimensions 17" FB x 12" LR x 8" DP

Rear drain wastehole location

FUN# 122.0183.167

18" cabinet - recommended minimum

OPTIONAL ACCESSORIES

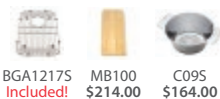

SUGGESTED KINDRED FITTINGS

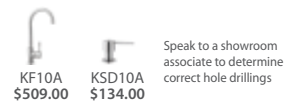

KINDRED COLLECTION • UNDERMOUNT SERIES • 18 GAUGE, 18-10 STAINLESS STEEL

KSS3UA/7D

\$379.00

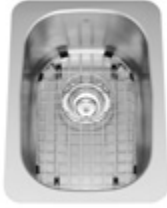

Undermount model



Shipping Weight 13.2 lbs. (6.0 kg.)

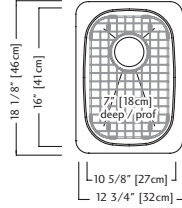

Outside sink rim dimensions 18 1/8" FB x 12 3/4" LR
Single bowl dimensions 16" FB x 10 5/8" LR x 7" DP

Rear drain wastehole location

FUN# 122.0183.168

18" cabinet - recommended minimum

OPTIONAL ACCESSORIES



BG355
Included!



MB100
\$214.00



C30S
\$125.00

SUGGESTED KINDRED FITTINGS



KF10A
\$509.00



KSD10A
\$134.00

Speak to a showroom associate to determine correct hole drillings

KSR1UA/9

\$659.00



Undermount model



Shipping Weight 13.0 lbs. (5.9 kg.)

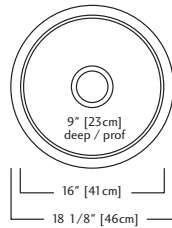

Outside sink rim dimensions 18 1/8" diameter
Single bowl dimensions 16" diameter x 9" DP

Center drain wastehole location

FUN# 122.0183.170

18" cabinet - recommended minimum

SUGGESTED KINDRED FITTINGS



KF10A
\$509.00



KSD10A
\$134.00

Speak to a showroom associate to determine correct hole drillings



BEYOND STYLISH GOOD LOOKS

Heavy 18 gauge stainless steel and slim profiles for more capacity.

Undercoated and sound dampening included.

Bottom grids and waste fittings included - no need to buy extras!

Rear drains for more storage below.

Easy to clean corners and finish on rims and bowls.

Installation instructions and template included.

Sizes and configurations to suit every space.

Easy to choose Easy to install Easy to use Easy to love



Vanity basin KSOV18U/7 shown.

Kindred Collection Vanity Basins

SMART AND STYLISH

No longer simply utilitarian spaces, bathrooms and powder rooms are now a canvas to create your personal statement in luxury and design. Kindred Collection stainless steel vanity basins satisfy with sanitary, robust and easy to maintain materials.

Choose from **undermount and topmount models**, in a variety of sizes and shapes. Stainless steel's chameleon like qualities mean a match to every decorating scheme, and a surface that is both easy to care for and hygienic.



KINDRED COLLECTION • VANITY BASINS • 18 GAUGE, 18-10 STAINLESS STEEL

KSOWB1119U/5

\$389.00



Undermount model

UPC® Shipping Weight 8.8 lbs. (4.0 kg.)

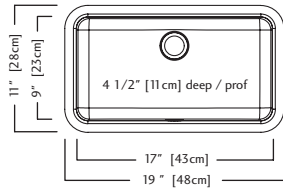

Outside sink rim dimensions 11" FB x 19" LR
 Single bowl dimensions 9" FB x 17" LR x 4 1/2" DP
 Includes front overflow waste assembly
 1 1/4" waste opening
Waste fitting not included
21" cabinet - recommended minimum

OPTIONAL ACCESSORIES



125GOWK
\$62.00

KSOWB1420U/5

\$529.00



Undermount model

UPC® Shipping Weight 8.8 lbs. (4.0 kg.)

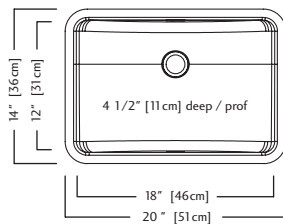

Outside sink rim dimensions 14" FB x 20" LR
 Single bowl dimensions 12" FB x 18" LR x 4 1/2" DP
 Includes front overflow waste assembly
 1 1/4" waste opening
Waste fitting not included
21" cabinet - recommended minimum

OPTIONAL ACCESSORIES



125GOWK
\$62.00

KSOV1420U/7

\$599.00



Undermount model

Shipping Weight 12.1 lbs. (5.5 kg.)

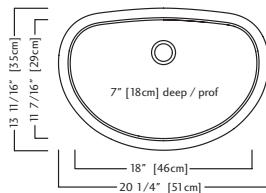

Outside sink rim dimensions 13 11/16" FB x 20 1/4" LR
 Single bowl dimensions 11 7/16" FB x 18" LR x 7" DP
 Includes front overflow waste assembly
 1 1/4" waste opening
Waste fitting not included
21" cabinet - recommended minimum

OPTIONAL ACCESSORIES



125GOWK
\$62.00

KSOV1318U/7

\$429.00



Undermount model

Shipping Weight 12.5 lbs. (5.7 kg.)

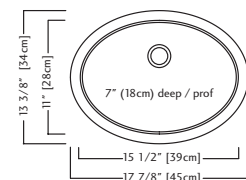

Outside sink rim dimensions 13 3/8" FB x 17 7/8" LR
 Single bowl dimensions 11" FB x 15 1/2" LR x 7" DP
 Includes front overflow waste assembly
 1 1/4" waste opening
Waste fitting not included
18" cabinet - recommended minimum

OPTIONAL ACCESSORIES



125GOWK
\$62.00

KINDRED COLLECTION • VANITY BASINS • 18 GAUGE, 18-10 STAINLESS STEEL

KSOV18U/7

\$439.00



Undermount model



Shipping Weight 6.3 lbs. (2.9 kg.)

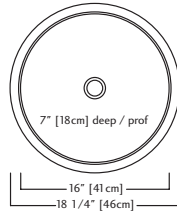

Outside sink rim dimensions 18 1/4" diameter
Single bowl dimensions 16" diameter x 7" DP

Includes front overflow waste assembly
1 1/4" waste opening

Waste fitting not included

18" cabinet - recommended minimum

OPTIONAL ACCESSORIES



125GOWK
\$62.00

KSOV16U/7

\$419.00



Undermount model



Shipping Weight 9.0 lbs. (4.1 kg.)

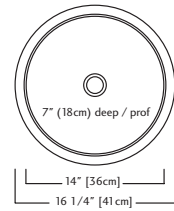

Outside sink rim dimensions 16 1/4" diameter
Single bowl dimensions 14" diameter x 7" DP

Includes front overflow waste assembly
1 1/4" waste opening

Waste fitting not included

18" cabinet - recommended minimum

OPTIONAL ACCESSORIES



125GOWK
\$62.00

KINDRED COLLECTION • VANITY BASINS • 18 GAUGE, 18-10 STAINLESS STEEL

KSOV1821/7

\$409.00



Topmount model



Shipping Weight 12.1 lbs. (5.5 kg.)

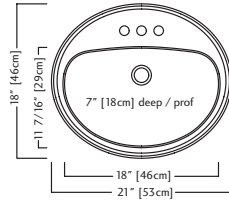

Outside sink rim dimensions 18" FB x 21" LR
Single bowl dimensions 11 7/16" FB x 18" LR x 7" DP

Faucet ledge
Includes front overflow assembly
1 1/4" waste opening

Waste fitting not included

Standard drilling: KSOV1821/7/3 - 3 hole - 1 1/8" diameter, 4" centers
Optional drilling: KSOV1821/7/1 - 1 hole on center

24" cabinet - recommended minimum

OPTIONAL ACCESSORIES



125GOWK
\$62.00

KSOV1619/7

\$359.00



Topmount model



Shipping Weight 6.0 lbs. (2.7 kg.)

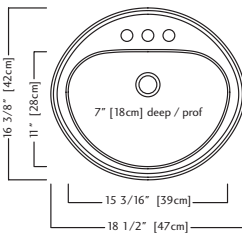

Outside sink rim dimensions 16 3/8" FB x 18 1/2" LR
Single bowl dimensions 11" FB x 15 3/16" LR x 7" DP

Faucet ledge
Includes front overflow assembly
1 1/4" waste opening

Waste fitting not included

Standard drilling: KSOV1619/7/3 - 3 hole, 1 1/8" diameter, 4" centers
Optional drilling: KSOV1619/7/1 - 1 hole on center

21" cabinet - recommended minimum

OPTIONAL ACCESSORIES



125GOWK
\$62.00

KSOV1418/7

\$349.00



Topmount model



Shipping Weight 12.5 lbs. (5.7 kg.)

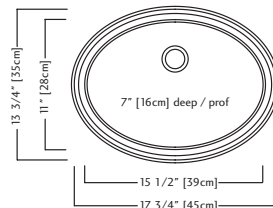

Outside sink rim dimensions 13 3/4" FB x 17 3/4" LR
Single bowl dimensions 11" FB x 15 1/2" LR x 7" DP

Includes front overflow assembly
1 1/4" waste opening

Waste fitting not included

21" cabinet - recommended minimum

OPTIONAL ACCESSORIES



125GOWK
\$62.00

KSOV17/7

\$339.00



Topmount model



Shipping Weight 9.9 lbs. (4.5 kg.)

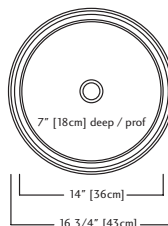

Outside sink rim dimensions 16 3/4" diameter
Single bowl dimensions 14" diameter x 7" DP

Includes front overflow assembly
1 1/4" waste opening

Waste fitting not included

21" cabinet - recommended minimum

OPTIONAL ACCESSORIES



125GOWK
\$62.00



- 1 Sanitized silver for hygiene
- 2 Integrated accessory ledge
- 3 Stainless steel bottom grid included



CH
Champagne



ES
Espresso

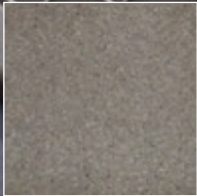

SM
Storm



ON
Onyx

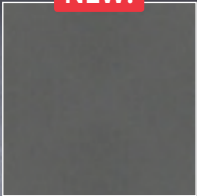

NEW!

SG
Shadow Grey

Sink model KGSL2031/85M shown with BG210SS bottom grid, KFPD1800 faucet and soap dispenser KSD1800.

KINDRED COLLECTION GRANITE

When stainless steel won't do may we recommend granite sinks for your kitchen. Molded of tough, hard wearing and easy-to-clean materials granite is a great alternative.

With its fashionable and contemporary lines our Kindred Mythos granite sinks are available in five fantastic colors. Don't be surprised when you open the box and find a stainless steel bottom grid packed right in with the sink, it's always included. For a completely coordinated look Kindred offers color matched faucets in all five granite colors ... simply stunning.



Kindred Granite Series

Evolution means constant change with a goal of improvement. Whether we're talking salamanders or sinks, to evolve means to change and adapt to new requirements, and to see benefit from those changes.

Kindred Granite models have evolved from first generation composite products to fourth generation leading edge designs and colors to Sanitized® silver materials.

Let us count the ways that Kindred Granite stands apart from the crowd ...

- Kindred Granite patented DuraKleen finish is smooth to the touch and easy to clean
- Kindred Granite is homogeneous
- Kindred Granite has a soft matte finish
- Kindred Granite boasts a tolerance for high temperatures up to 280 degrees Celsius
- Kindred Granite is colorfast
- Kindred Granite is scratch resistant
- Kindred Granite has superior thermal shock characteristics
- Kindred Granite feels warm to the touch and will insulate hot water
- Kindred Granite sinks are quiet
- Kindred Granite colors are available in color matched faucets and soap dispensers

Kindred Granite sinks ... an inspired idea that has come of age!

KINDRED GRANITE • SANITIZED® • COLOR GRANITE COMPOSITE

KGDL2031/8

\$749.00



Topmount model



Shipping Weight 58.6 lbs. (26.6 kg.)

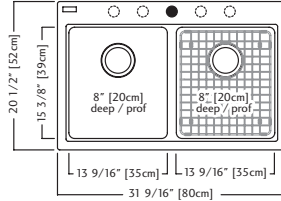

Outside sink rim dimensions 20 1/2" FB x 31 9/16" LR
Equal size bowl dimensions 15 3/8" FB x 13 9/16" LR x 8" DP
Rear drain wastehole locations

Standard drilling: 1 hole, knockouts (4) allow holes to be added on-site

- KGDL2031/8CH - Champagne FUN# 114.0055.298
- KGDL2031/8ES - Espresso FUN# 114.0183.173
- KGDL2031/8SM - Storm FUN# 114.0394.651
- KGDL2031/8ON - Onyx FUN# 114.0153.125
- KGDL2031/8SG - Shadow Grey FUN# 114.0528.031

33" cabinet - recommended minimum

OPTIONAL ACCESSORIES

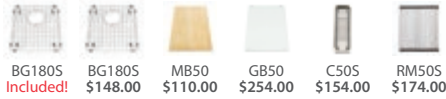

COLORS AVAILABLE

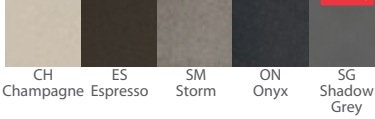

SUGGESTED KINDRED FITTINGS

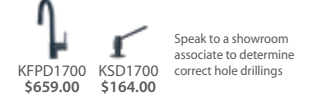

KGDC2031R/8

\$799.00



Topmount model



Shipping Weight 48.0 lbs. (21.7 kg.)

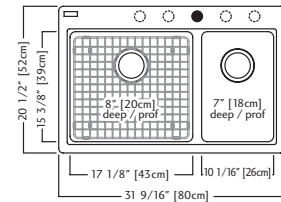

Outside sink rim dimensions 20 1/2" FB x 31 9/16" LR
Large bowl dimensions 15 3/8" FB x 17 1/8" LR x 8" DP
Small bowl dimensions 15 3/8" FB x 10 1/16" LR x 7" DP
Rear drain wastehole locations

Standard drilling: 1 hole, knockouts (4) allow holes to be added on-site

- KGDC2031R/8CH - Champagne FUN# 114.0061.203
- KGDC2031R/8ES - Espresso FUN# 114.0202.022
- KGDC2031R/8SM - Storm FUN# 114.0394.652
- KGDC2031R/8ON - Onyx FUN# 114.0183.174
- KGDC2031R/8SG - Shadow Grey FUN# 114.0528.031

33" cabinet - recommended minimum

OPTIONAL ACCESSORIES

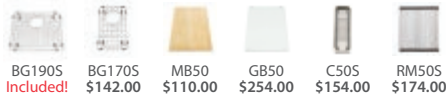

COLORS AVAILABLE

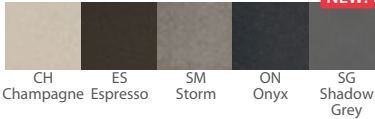

SUGGESTED KINDRED FITTINGS

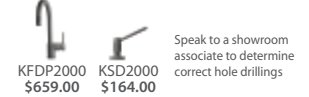

KGDC2027R/8

\$749.00



Topmount model



Shipping Weight 41.0 lbs. (18.6 kg.)

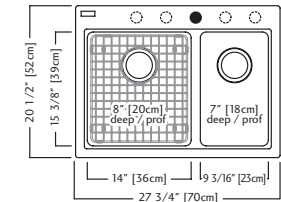

Outside sink rim dimensions 20 1/2" FB x 27 3/4" LR
Large bowl dimensions 15 3/8" FB x 14" LR x 8" DP
Small bowl dimensions 15 3/8" FB x 9 3/16" LR x 7" DP
Rear drain wastehole locations

Standard drilling: 1 hole, knockouts (4) allow holes to be added on-site

- KGDC2027R/8CH - Champagne FUN# 114.0055.309
- KGDC2027R/8ES - Espresso FUN# 114.0202.023
- KGDC2027R/8SM - Storm FUN# 114.0394.653
- KGDC2027R/8ON - Onyx FUN# 114.0183.176
- KGDC2027R/8SG - Shadow Grey FUN# 114.0528.032

30" cabinet - recommended minimum

OPTIONAL ACCESSORIES

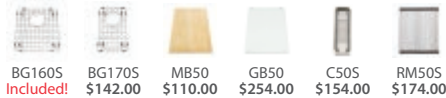

COLORS AVAILABLE

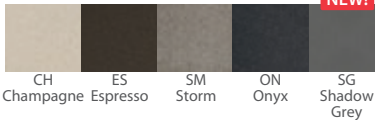

SUGGESTED KINDRED FITTINGS

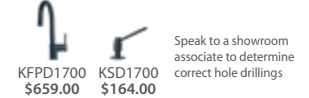

KGSL2031/8

\$809.00



Topmount model



Shipping Weight 35.0 lbs. (15.3 kg.)

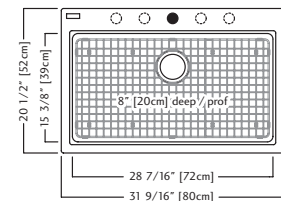

Outside sink rim dimensions 20 1/2" FB x 31 9/16" LR
Single bowl dimensions 15 3/8" FB x 28 7/16" LR x 8" DP
Rear drain wastehole location

Standard drilling: 1 hole, knockouts (4) allow holes to be added on-site

- KGSL2031/8CH - Champagne FUN# 114.0055.323
- KGSL2031/8ES - Espresso FUN# 114.0202.024
- KGSL2031/8SM - Storm FUN# 114.0394.654
- KGSL2031/8ON - Onyx FUN# 114.0183.177
- KGSL2031/8SG - Shadow Grey FUN# 114.0528.033

33" cabinet - recommended minimum

OPTIONAL ACCESSORIES



COLORS AVAILABLE

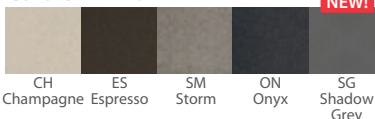

SUGGESTED KINDRED FITTINGS



KINDRED GRANITE • SANITIZED® • COLOR GRANITE COMPOSITE

KGSL2023/8

\$729.00



Topmount model



Shipping Weight 33.0 lbs. (14.9 kg.)

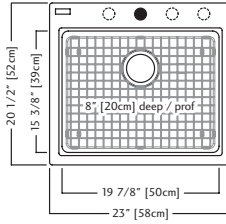

Outside sink rim dimensions 20 1/2" FB x 23" LR
Single bowl dimensions 15 3/8" FB x 19 7/8" LR x 8" DP

Rear drain wastehole location

Standard drilling: 1 hole, knockouts (4) allow holes to be added on-site

KGSL2023/8CH - Champagne FUN# 114.0055.318
KGSL2023/8ES - Espresso FUN# 114.0183.181
KGSL2023/8SM - Storm FUN# 114.0394.655
KGSL2023/8ON - Onyx FUN# 114.0183.179
KGSL2023/8SG - Shadow Grey FUN# 114.0528.034
27" cabinet - recommended minimum

OPTIONAL ACCESSORIES



COLORS AVAILABLE

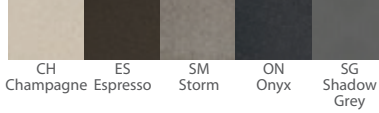

SUGGESTED KINDRED FITTINGS



KGSL2017/8

\$639.00



Topmount model



Shipping Weight 36.0 lbs. (16.4 kg.)

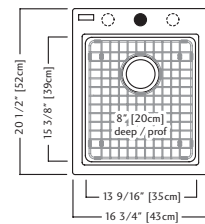

Outside sink rim dimensions 20 1/2" FB x 16 3/4" LR
Single bowl dimensions 15 3/8" FB x 13 9/16" LR x 8" DP

Rear drain wastehole location

Standard drilling: 1 hole, knockouts (2) allow holes to be added on-site

KGSL2017/8CH - Champagne FUN# 114.0061.208
KGSL2017/8ES - Espresso FUN# 114.0183.329
KGSL2017/8SM - Storm FUN# 114.0394.656
KGSL2017/8ON - Onyx FUN# 114.0183.182
KGSL2017/8SG - Shadow Grey FUN# 114.0528.035

18" cabinet - recommended minimum

OPTIONAL ACCESSORIES



COLORS AVAILABLE

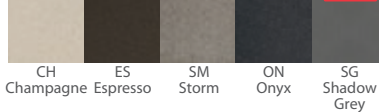

SUGGESTED KINDRED FITTINGS

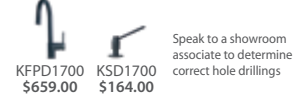

KGDL2233/9

\$919.00



Topmount model



Shipping Weight 41.0 lbs. (18.8 kg.)

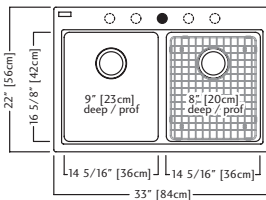

Outside sink rim dimensions 22" FB x 33" LR
Equal size bowl dimensions 16 5/8" FB x 14 5/16" LR x 8" DP

Rear drain wastehole location

Standard drilling: 1 hole, knockouts (4) allow holes to be added on-site

KGDL2233/9CH - Champagne FUN# 114.0055.328
KGDL2233/9ES - Espresso FUN# 114.0202.025
KGDL2233/9SM - Storm FUN# 114.0530.122
KGDL2233/9ON - Onyx FUN# 114.0168.162
KGDL2233/9SG - Shadow Grey FUN# 114.0530.121

36" cabinet - recommended minimum

OPTIONAL ACCESSORIES



COLORS AVAILABLE

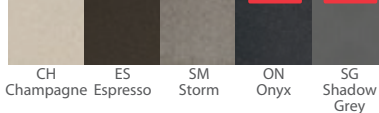

SUGGESTED KINDRED FITTINGS



KGD1U/8

\$799.00



Undermount model



Shipping Weight 47.1 lbs. (21.3 kg.)

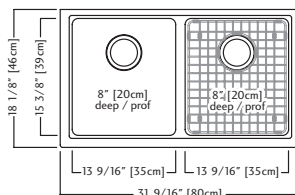

Outside sink rim dimensions 18 1/8" FB x 31 9/16" LR
Equal size bowl dimensions 15 3/8" FB x 13 9/16" LR x 8" DP

Rear drain wastehole location

KGD1U/8CH - Champagne FUN# 114.0061.222
KGD1U/8ES - Espresso FUN# 125.0183.331
KGD1U/8SM - Storm FUN# 125.0394.657
KGD1U/8ON - Onyx FUN# 125.0183.330
KGD1U/8SG - Shadow Grey FUN# 125.0528.036

33" cabinet - recommended minimum

OPTIONAL ACCESSORIES

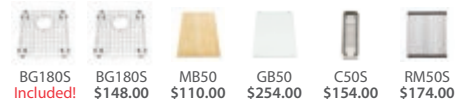

COLORS AVAILABLE

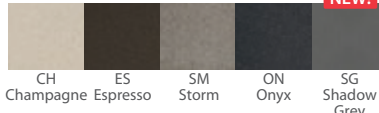

SUGGESTED KINDRED FITTINGS

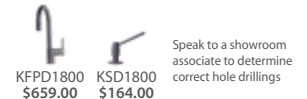

KINDRED GRANITE • SANITIZED® • COLOR GRANITE COMPOSITE

KGDCR1U/8

\$889.00



Undermount model



Shipping Weight 48.0 lbs. (21.7 kg.)

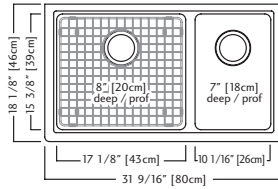

Outside sink rim dimensions 18 1/8" FB x 31 9/16" LR
Large bowl dimensions 15 3/8" FB x 17 1/8" LR x 8" DP
Small bowl dimensions 15 3/8" FB x 10 1/16" LR x 7" DP

Rear drain wastehole location

KGDCR1U/8CH - Champagne FUN# 125.0055.314
KGDCR1U/8ES - Espresso FUN# 125.0202.026
KGDCR1U/8SM - Storm FUN# 125.0394.658
KGDCR1U/8ON - Onyx FUN# 125.0183.332
KGDCR1U/8SG - Shadow Grey FUN# 125.0528.037

33" cabinet - recommended minimum

OPTIONAL ACCESSORIES

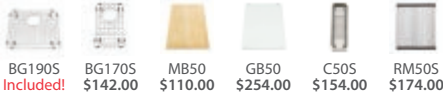

COLORS AVAILABLE

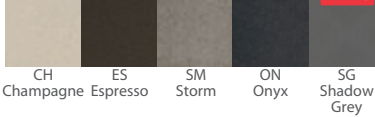

SUGGESTED KINDRED FITTINGS



KGDC2RU/8

\$809.00



Undermount model



Shipping Weight 41.0 lbs. (18.6 kg.)

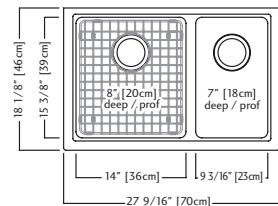

Outside sink rim dimensions 18 1/8" FB x 27 9/16" LR
Large bowl dimensions 15 3/8" FB x 14" LR x 8" DP
Small bowl dimensions 15 3/8" FB x 9 3/16" LR x 7" DP

Rear drain wastehole location

KGDC2RU/8CH - Champagne FUN# 114.0061.232
KGDC2RU/8ES - Espresso FUN# 125.0202.027
KGDC2RU/8SM - Storm FUN# 125.0394.659
KGDC2RU/8ON - Onyx FUN# 125.0183.334
KGDC2RU/8SG - Shadow Grey FUN# 125.0528.038

27" cabinet - recommended minimum

OPTIONAL ACCESSORIES

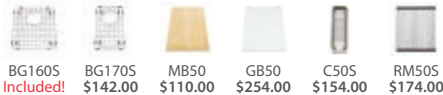

COLORS AVAILABLE

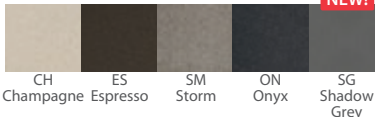

SUGGESTED KINDRED FITTINGS



KGSIU/8

\$839.00



Undermount model



Shipping Weight 35.0 lbs. (15.3 kg.)

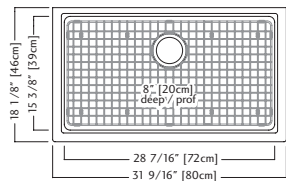

Outside sink rim dimensions 18" FB x 31 9/16" LR
Single bowl dimensions 15 3/8" FB x 28 7/16" LR x 8" DP

Rear drain wastehole location

KGSIU/8CH - Champagne FUN# 125.0078.233
KGSIU/8ES - Espresso FUN# 125.0202.340
KGSIU/8SM - Storm FUN# 125.0394.660
KGSIU/8ON - Onyx FUN# 125.0183.334
KGSIU/8SG - Shadow Grey FUN# 125.0528.039

33" cabinet - recommended minimum

OPTIONAL ACCESSORIES

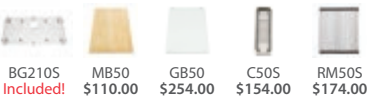

COLORS AVAILABLE

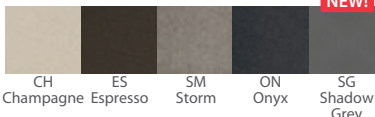

SUGGESTED KINDRED FITTINGS



KGSIU/8

\$769.00



Undermount model



Shipping Weight 33.0 lbs. (14.9 kg.)

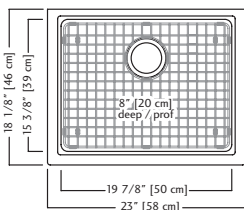

Outside sink rim dimensions 18 1/8" FB x 23" LR
Single bowl dimensions 15 3/8" FB x 19 7/8" LR x 8" DP

Rear drain wastehole location

KGSIU/8CH - Champagne FUN# 125.0078.169
KGSIU/8ES - Espresso FUN# 125.0183.966
KGSIU/8SM - Storm FUN# 125.0394.661
KGSIU/8ON - Onyx FUN# 125.0183.335
KGSIU/8SG - Shadow Grey FUN# 125.0528.040

24" cabinet - recommended minimum

OPTIONAL ACCESSORIES

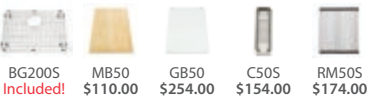

COLORS AVAILABLE

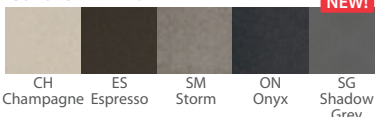

SUGGESTED KINDRED FITTINGS



KINDRED GRANITE • SANITIZED® • COLOR GRANITE COMPOSITE

KGS3U/8

\$659.00



Undermount model

Shipping Weight 36.0 lbs. (16.3 kg.)

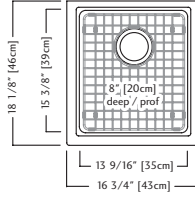

Outside sink rim dimensions 18 1/8" FB x 16 3/4" LR
Single bowl dimensions 15 3/8" FB x 13 9/16" LR x 8" DP

Rear drain wastehole location

KGS3U/8CH - Champagne FUN# 125.0078.228
KGS3U/8ES - Espresso FUN# 125.0183.966
KGS3U/8SM - Storm FUN# 125.0394.661
KGS3U/8ON - Onyx FUN# 125.0183.336
KGS3U/8SG - Shadow Grey FUN# 125.0528.041

18" cabinet - recommended minimum

OPTIONAL ACCESSORIES

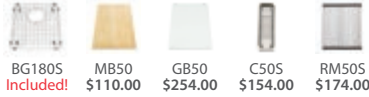

COLORS AVAILABLE

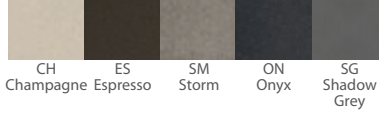

SUGGESTED KINDRED FITTINGS

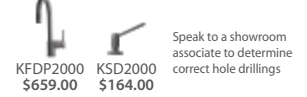

KGD2U/9

\$979.00



Undermount model

Shipping Weight 41.0 lbs. (18.8 kg.)

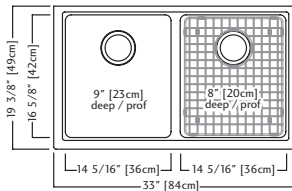

Outside sink rim dimensions 19 3/8" FB x 33" LR
Large bowl dimensions 16 5/8" FB x 14 5/16" LR x 9" DP
Small bowl dimensions 16 5/8" FB x 14 5/16" LR x 8" DP

Rear drain wastehole location

KGD2U/9CH - Champagne FUN# 114.0061.252
KGD2U/9ES - Espresso FUN# 125.0203.913
KGD2U/9SM - Storm FUN# 125.0530.124
KGD2U/9ON - Onyx FUN# 125.0168.161
KGD2U/9SG - Shadow Grey FUN# 125.0530.123

33" cabinet - recommended minimum

OPTIONAL ACCESSORIES



COLORS AVAILABLE

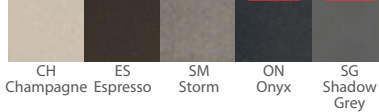

SUGGESTED KINDRED FITTINGS

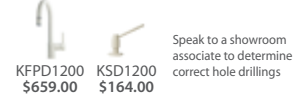

Kindred Granite Faucets & Soap Dispensers

A BEAUTIFUL ADDITION

Want to know what works well with a Kindred sink? A Kindred Faucet! All the popular finishes are available and while chrome may be considered the kitchen standard we go beyond ordinary to extraordinary with color matched granite faucets to complement your Kindred Granite sink.

It's important to know Kindred faucets have been machined from solid brass castings. Plastic moldings have been restricted to use where this technology is required. We believe that function comes first, not cost savings.

You've selected the sink; now add the **finest finishing touch** with Kindred faucets.



KFPD1200 / KSD1200
Champagne Finish

KFPD2000 / KSD2000
Shadow Grey Finish

KFPD1700 / KSD1700
Onyx Finish

KFPD1800 / KSD1800
Espresso Finish

KFPD1900 / KSD1900
Storm Finish



- 1 Satin finished rim and bowls
- 2 Lifetime mechanical warranty on faucet
- 3 2.2 gpm water saver rate

K I N D R E D S T E E L Q U E E N

Design and Quality

The Kindred Steel Queen family has a long and proud history in the plumbing industry, where it is known for great value, easy to care for finishes, and sizes and shapes for virtually any room in your home. Choose from hand fabricated sinks with commercial finishes in Apron Front, Undermount and Dual Mount models; traditional Topmount and Undermount models with easy care finishes; and even accessorized sinks, all in great value 20 gauge stainless steel.

Durable by Any Standard

We realize that purchase of a Kindred Steel Queen sink is an important decision. Kindred includes all the essentials that you will need in every Kindred Steel Queen package, time saving installation hardware, factory applied rimseal, illustrated installation instructions, and a template for marking and cutting the countertop. And did we mention that Kindred Steel Queen sinks are **easy to install**. You don't need to be a master plumber to install our product.



Sink model QDLF2031/8 shown with KFPD1100 faucet, KSD1100 soap dispenser and MBZ16 cutting board.

Kindred Steel Queen Fabricated Kitchen Sinks

Every Steel Queen 20 gauge fabricated sink is created to exacting specifications, with tight corners, and robust commercial satin finishes on all surfaces. As with all Steel Queen products, we include waste fittings, sound dampening pads, undercoating, rim seal, installation hardware, template and illustrated installation instructions, to ensure that you have **everything you need.**

APRON FRONT

Steel Queen apron front sinks are available in single bowl and double bowl models, both of which are shipped complete with stainless steel bottom grids, right in the sink carton. A sweeping bow front is sure to stand out in your kitchen whether installed flush with the countertop, below it, or slightly elevated.

DUAL MOUNT

Born of innovative design, with an eye to versatility, Steel Queen dual mount models embrace contemporary design at a mid price point. Steel Queen dual mount models feature a remarkably flat deck to allow for installation as a topmount or below the counter as an undermount.

UNDERMOUNT

Great value, sleek zero radius bowl corners, and the most popular sizes for kitchen and island applications, all with creased bowl bottoms for efficient draining, and an easy to care for commercial finish.



STEEL QUEEN FABRICATED SINKS - DUAL MOUNT - 20 GAUGE, 18-8 STAINLESS STEEL

QDLY2031/8

\$939.00

cUPC®



Topmount or undermount model

20 mm radius coved corners

Shipping Weight 30.0 lbs. (13.6 kg.)

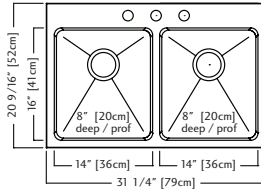

Outside sink dimensions 20 9/16" FB x 31 1/4" LR
Equal size bowl dimensions 16" FB x 14" LR x 8" DP

Rear drain wastehole location, faucet ledge
Bowl is pitched to the center of the wastehole

Standard drilling: QDLY2031/8/3 - 3 hole - 1 1/2" dia., 4" center-to-center

FUN# 101.0488.366

Optional drilling: QDLY2031/8/1 - 1 hole on center

FUN# 101.0488.365

33" cabinet - recommended minimum

OPTIONAL ACCESSORIES



BGZ145 \$148.00
BGZ145 \$148.00
DBR105 \$140.00
MBZ16 \$161.00

SUGGESTED KINDRED FITTINGS



KFPD1150 \$719.00
KSD1150 \$184.00

Speak to a showroom associate to determine correct hole drillings

QSLY2225/8

\$779.00

cUPC®



Topmount or undermount model

20 mm radius coved corners

Shipping Weight 25.0 lbs. (11.3 kg.)

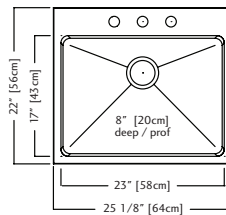

Outside sink dimensions 22" FB x 25 1/8" LR
Single bowl dimensions 17" FB x 23" LR x 8" DP

Rear drain wastehole location, faucet ledge
Bowl is pitched to the center of the wastehole

Standard drilling: QSLY2225/8/3 - 3 hole - 1 1/2" dia., 4" center-to-center

FUN# 101.0488.368

Optional drilling: QSLY2225/8/1 - 1 hole on center

FUN# 101.0488.367

27" cabinet - recommended minimum

OPTIONAL ACCESSORIES



BGZ235 \$169.00
DBR105 \$140.00
MBZ16 \$161.00

SUGGESTED KINDRED FITTINGS

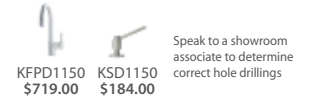

KFPD1150 \$719.00
KSD1150 \$184.00

Speak to a showroom associate to determine correct hole drillings

QSLY2020/8

\$689.00

cUPC®



Topmount or undermount model

20 mm radius coved corners

Shipping Weight 20.0 lbs. (9.1 kg.)

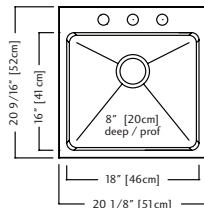

Outside sink dimensions 20 9/16" FB x 20 1/8" LR
Single bowl dimensions 16" FB x 18" LR x 8" DP

Rear drain wastehole location, faucet ledge
Bowl is pitched to the center of the wastehole

Standard drilling: QSLY2020/8/3 - 3 hole - 1 1/2" dia., 4" center-to-center

FUN# 101.0488.370

Optional drilling: QSLY2020/8/1 - 1 hole on center

FUN# 101.0488.369

24" cabinet - recommended minimum

OPTIONAL ACCESSORIES



BGZ185 \$164.00
DBR105 \$140.00
MBZ16 \$161.00

SUGGESTED KINDRED FITTINGS



KFPD1150 \$719.00
KSD1150 \$184.00

Speak to a showroom associate to determine correct hole drillings

STEEL QUEEN FABRICATED SINKS • APRON FRONT & DUAL MOUNT • 20 GAUGE, 18-8 STAINLESS STEEL

QDFS31B

\$1,209.00

cUPC®



Apron front model
Zero radius corners
 Shipping Weight 55.3 lbs. (25.1 kg.)

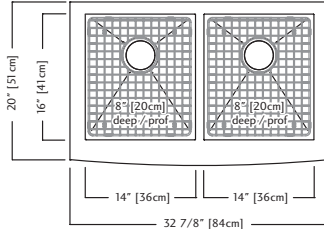

Outside sink dimensions 20" FB x 32 7/8" LR
 Equal size bowl dimensions 16" FB x 14" LR x 8" DP
 Rear drain wastehole location
 Bowls are pitched to the center of the wastehole
 Standard drilling: QDFS31B - no hole
FUN# 123.0285.882

33" cabinet - recommended minimum

OPTIONAL ACCESSORIES



BGDS145 **Included!** BGDS145 **Included!**

SUGGESTED KINDRED FITTINGS



KFPD1150 **\$719.00** KSD1150 **\$184.00**

Speak to a showroom associate to determine correct hole drillings

QSFS31B

\$1,159.00

cUPC®



Apron front model
Zero radius corners
 Shipping Weight 23.3 lbs. (10.6 kg.)

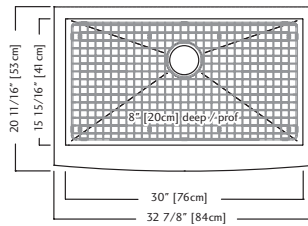

Outside sink dimensions 20 11/16" FB x 32 7/8" LR
 Equal size bowl dimensions 15 15/16" FB x 30" LR x 8" DP
 Rear drain wastehole location
 Bowl is pitched to the center of the wastehole
 Standard drilling: QSFS31B - no hole
FUN# 123.0285.886

33" cabinet - recommended minimum

OPTIONAL ACCESSORIES



BGDS305 **Included!**

SUGGESTED KINDRED FITTINGS



KFPD1150 **\$719.00** KSD1150 **\$184.00**

Speak to a showroom associate to determine correct hole drillings

QDLF2233/8

\$1,059.00

cUPC®



Topmount or undermount model
Zero radius corners
 Shipping Weight 19.3 lbs. (8.8 kg.)

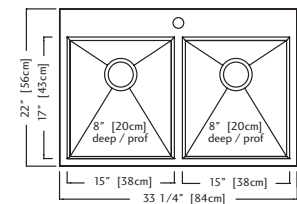

Outside sink dimensions 22" FB x 33 1/4" LR
 Equal size bowl dimensions 17" FB x 15" LR x 8" DP
 Rear drain wastehole location, faucet ledge
 Bowl is pitched to the center of the wastehole
 Standard drilling: QDLF2233/8/3 - 3 hole - 1 1/2" dia., 4" center-to-center
FUN# 101.0191.930
 Optional drilling: QDLF2233/8/1 - 1 hole on center
FUN# 101.0191.929

33" cabinet - recommended minimum

OPTIONAL ACCESSORIES



BGZ155 **\$154.00** BGZ155 **\$154.00** MBZ17 **\$161.00** DBR105 **\$140.00**

SUGGESTED KINDRED FITTINGS



KFPD1150 **\$719.00** KSD1150 **\$184.00**

Speak to a showroom associate to determine correct hole drillings

QDLF2031/8

\$829.00

cUPC®



Topmount or undermount model
Zero radius corners
 Shipping Weight 33.3 lbs. (14.8 kg.)

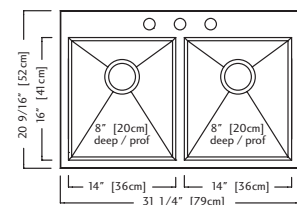

Outside sink dimensions 20 9/16" FB x 31 1/4" LR
 Equal size bowl dimensions 16" FB x 14" LR x 8" DP
 Rear drain wastehole location, faucet ledge
 Bowl is pitched to the center of the wastehole
 Standard drilling: QDLF2031/8/3 - 3 hole - 1 1/2" dia., 4" center-to-center
FUN# 101.0191.924
 Optional drilling: QDLF2031/8/1 - 1 hole on center
FUN# 101.0191.923

33" cabinet - recommended minimum

OPTIONAL ACCESSORIES



BGZ145 **\$148.00** BGZ145 **\$148.00** MBZ16 **\$161.00** DBR105 **\$140.00**

SUGGESTED KINDRED FITTINGS



KFPD1150 **\$719.00** KSD1150 **\$184.00**

Speak to a showroom associate to determine correct hole drillings

STEEL QUEEN FABRICATED SINKS • DUAL MOUNT • 20 GAUGE, 18-8 STAINLESS STEEL

QCLF2031R/8

\$849.00

cUPC®



Topmount or undermount model

Zero radius corners

Shipping Weight 34.1 lbs. (15.2 kg.)

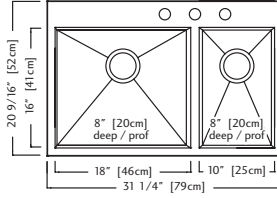

Outside sink dimensions 20 9/16" FB x 31 1/4" LR

Large bowl dimensions 16" FB x 18" LR x 8" DP

Small bowl dimensions 16" FB x 10" LR x 8" DP

Rear drain wastehole location, faucet ledge
Bowl is pitched to the center of the wastehole

Standard drilling: QCLF2031R/8/3 - 3 hole - 1 1/2" dia., 4" center-to center

FUN# 101.0191.927

Optional drilling: QCLF2031R/8/1 - 1 hole on center

FUN# 101.0191.926

33" cabinet - recommended minimum

OPTIONAL ACCESSORIES



BGZ185 \$164.00
BGZ105 \$142.00
MBZ16 \$161.00
DBR105 \$140.00

SUGGESTED KINDRED FITTINGS



Speak to a showroom associate to determine correct hole drillings

KFPD1150 \$719.00
KSD1150 \$184.00

QCLF2027R/8

\$839.00

cUPC®



Topmount or undermount model

Zero radius corners

Shipping Weight 31.7 lbs. (14.2 kg.)

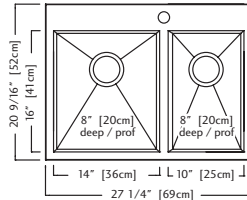

Outside sink dimensions 20 9/16" FB x 27 1/4" LR

Large bowl dimensions 16" FB x 14" LR x 8" DP

Small bowl dimensions 16" FB x 10" LR x 8" DP

Rear drain wastehole location, faucet ledge
Bowl is pitched to the center of the wastehole

Standard drilling: QCLF2027R/8/3 - 3 hole - 1 1/2" dia., 4" center-to center

FUN# 101.0191.921

Optional drilling: QCLF2027R/8/1 - 1 hole on center

FUN# 101.0191.920

27" cabinet - recommended minimum

OPTIONAL ACCESSORIES



BGZ145 \$148.00
BGZ105 \$142.00
MBZ16 \$161.00
DBR105 \$140.00

SUGGESTED KINDRED FITTINGS

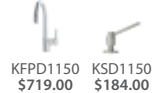

Speak to a showroom associate to determine correct hole drillings

KFPD1150 \$719.00
KSD1150 \$184.00

QCLF2039DBR/8

\$1,099.00

cUPC®



Topmount or undermount model

Zero radius corners

Shipping Weight 38.2 lbs. (17.0 kg.)

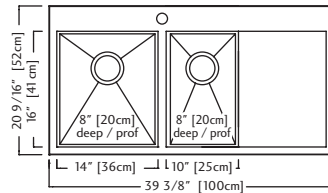

Outside sink dimensions 20 9/16" FB x 39 3/8" LR

Large bowl dimensions 16" FB x 14" LR x 8" DP

Small bowl dimensions 16" FB x 10" LR x 8" DP

Rear drain wastehole location, faucet ledge
Bowl is pitched to the center of the wastehole

Standard drilling: QCLF2039DBR/8/3 - 3 hole - 1 1/2" dia., 4" center-to center

FUN# 101.0191.933

Optional drilling: QCLF2039DBR/8/1 - 1 hole on center

FUN# 101.0191.932

27" cabinet - recommended minimum

OPTIONAL ACCESSORIES



BGZ145 \$148.00
BGZ105 \$142.00
MB1610 \$89.00
DBR105 \$140.00

SUGGESTED KINDRED FITTINGS



Speak to a showroom associate to determine correct hole drillings

KFPD1150 \$719.00
KSD1150 \$184.00

QSLF2225/8

\$679.00

cUPC®



Topmount or undermount model

Zero radius corners

Shipping Weight 27.8 lbs. (12.4 kg.)

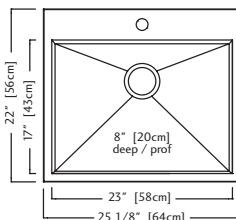

Outside sink dimensions 22" FB x 25 1/8" LR

Single bowl dimensions 17" FB x 23" LR x 8" DP

Rear drain wastehole location, faucet ledge
Bowl is pitched to the center of the wastehole

Standard drilling: QSLF2225/8/3 - 3 hole - 1 1/2" dia., 4" center-to center

FUN# 101.0191.918

Optional drilling: QSLF2225/8/1 - 1 hole on center

FUN# 101.0191.917

27" cabinet - recommended minimum

OPTIONAL ACCESSORIES



BGZ235 \$169.00
MBZ17 \$161.00
DBR105 \$140.00

SUGGESTED KINDRED FITTINGS



Speak to a showroom associate to determine correct hole drillings

KFPD1150 \$719.00
KSD1150 \$184.00

STEEL QUEEN FABRICATED SINKS • DUAL MOUNT • 20 GAUGE, 18-8 STAINLESS STEEL

QSLF2020/8

\$609.00

cUPC®

Topmount or undermount model
Zero radius corners

Shipping Weight 22.8 lbs. (10.2 kg.)

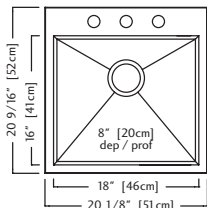

Outside sink dimensions 20 9/16" FB x 20 1/8" LR
Single bowl dimensions 16" FB x 18" LR x 8" DP

Rear drain wastehole location, faucet ledge
Bowl is pitched to the center of the wastehole

Standard drilling: QSLF2020/8/3 - 3 hole - 1 1/2" dia., 4" center-to center
FUN# 101.0191.915
Optional drilling: QSLF2020/8/1 - 1 hole on center
FUN# 101.0191.914

21" cabinet - recommended minimum

OPTIONAL ACCESSORIES

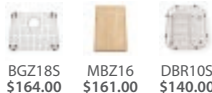

BGZ185 \$164.00 MBZ16 \$161.00 DBR10S \$140.00

SUGGESTED KINDRED FITTINGS



KFPD1150 \$719.00 KSD1150 \$184.00

Speak to a showroom associate to determine correct hole drillings

QSLF1717/7

\$559.00

cUPC®

Topmount or undermount model
Zero radius corners

Shipping Weight 17.0 lbs. (7.6 kg.)

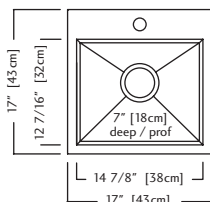

Outside sink dimensions 17" FB x 17" LR
Single bowl dimensions 12 7/16" FB x 14 7/8" LR x 7" DP

Rear drain wastehole location, faucet ledge
Bowl is pitched to the center of the wastehole

Optional drilling: QSLF1717/7/1 - 1 hole on center
FUN# 101.0307.432

18" cabinet - recommended minimum

OPTIONAL ACCESSORIES



BGZ1512S \$142.00

SUGGESTED KINDRED FITTINGS



KFPD1150 \$719.00 KSD1150 \$184.00

Speak to a showroom associate to determine correct hole drillings

QSLF2016/8

\$669.00

cUPC®

Topmount or undermount model
Zero radius corners

Shipping Weight 19.8 lbs. (8.8 kg.)

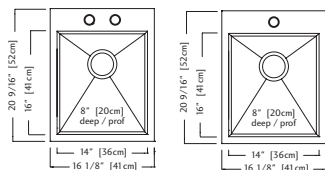

Outside sink dimensions 20 9/16" FB x 16 1/8" LR
Single bowl dimensions 16" FB x 14" LR x 8" DP

Rear drain wastehole location, faucet ledge
Bowl is pitched to the center of the wastehole

Standard drilling: QSLF2016/8/2 - 2 hole - 1 1/2" dia., 4" center-to center
FUN# 101.0191.913
Optional drilling: QSLF2016/8/1 - 1 hole on center
FUN# 101.0191.911

18" cabinet - recommended minimum

OPTIONAL ACCESSORIES

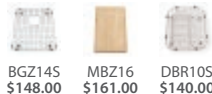

BGZ14S \$148.00 MBZ16 \$161.00 DBR10S \$140.00

SUGGESTED KINDRED FITTINGS



KFPD1150 \$719.00 KSD1150 \$184.00

Speak to a showroom associate to determine correct hole drillings



Sink model QDFU1831/8 shown with MBZ16 cutting board, KFPD1100 faucet and KSD1100 soap dispenser.

Steel Queen 20 Gauge Hand Fabricated Undermount Sinks

EXAMPLARY DESIGN

The Kindred brand is well known for both innovation and **commitment to quality**, with solid product warranties and value added features - a reputation we have earned over our 70 years in the design and manufacture of sinks. Our engineers and production teams have been instrumental in leading our industry from its very infancy with intelligent design rendered in robust, top grade - traditions we are pleased to continue to this day!

And, as with everyone, value is important to us. We believe that value can be found in all product categories. From rear drains for more storage below the sink, to sound dampening and undercoating for a quiet sink, to included waste fittings and installation template and directions, value comes in many forms.

Our offering of hand fabricated 20 ga undermount sinks feature sleek, zero radius bowl corners, an easy commercial satin finish, creased bowl bottoms that are pitched to the drains for efficient drainage, and rear drains for more storage below. 20 ga handfab undermount sinks that speak to exemplary design and great value.

STEEL QUEEN FABRICATED SINKS • UNDERMOUNT • 20 GAUGE, 18-8 STAINLESS STEEL

QDFU1831/8

\$639.00

UPC®

Zero radius corners

Shipping Weight 18.0 lbs. (8.2 kg.)

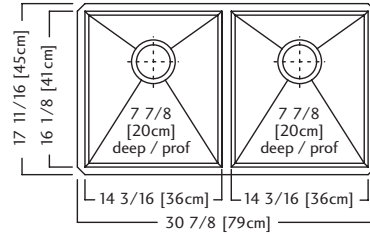

Outside sink rim dimensions 17 11/16" FB x 30 7/8" LR
Equal size bowl dimensions 16 1/8" FB x 14 3/16" LR x 7 7/8" DP

Rear drain wastehole locations
Bowls are pitched to the center of the wastehole

Undermount template included

FUN# 122.0456.838

33" cabinet - recommended minimum

OPTIONAL ACCESSORIES

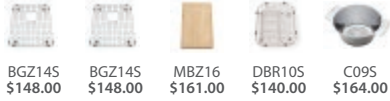

BGZ14S \$148.00
BGZ14S \$148.00
MBZ16 \$161.00
DBR10S \$140.00
C09S \$164.00

SUGGESTED KINDRED FITTINGS

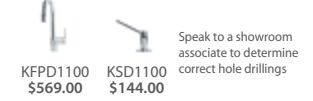

KFPD1100 \$569.00
KSD1100 \$144.00
Speak to a showroom associate to determine correct hole drillings

QSFU1925/8

\$509.00

UPC®

Zero radius corners

Shipping Weight 15.0 lbs. (6.8 kg.)

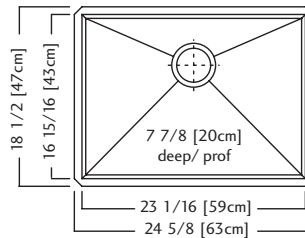

Outside sink rim dimensions 18 1/2" FB x 24 5/8" LR
Single bowl dimensions 16 15/16" FB x 23 1/16" LR x 7 7/8" DP

Rear drain wastehole location
Bowl is pitched to the center of the wastehole

Undermount template included

FUN# 122.0456.840

27" cabinet - recommended minimum

OPTIONAL ACCESSORIES



BGZ23S \$169.00
MBZ17 \$161.00
DBR10S \$140.00
C09S \$164.00

SUGGESTED KINDRED FITTINGS

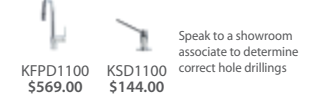

KFPD1100 \$569.00
KSD1100 \$144.00
Speak to a showroom associate to determine correct hole drillings

QSFU1820/8

\$459.00

UPC®

Zero radius corners

Shipping Weight 13.0 lbs. (5.9 kg.)

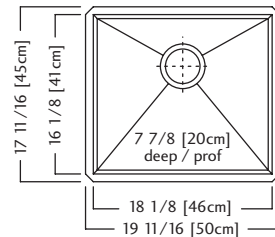

Outside sink rim dimensions 17 11/16" FB x 19 11/16" LR
Single bowl dimensions 16 1/8" FB x 18 1/8" LR x 7 7/8" DP

Rear drain wastehole location
Bowl is pitched to the center of the wastehole

Undermount template included

FUN# 122.0456.839

21" cabinet - recommended minimum

OPTIONAL ACCESSORIES



BGZ18S \$164.00
MBZ16 \$161.00
DBR10S \$140.00
C09S \$164.00

SUGGESTED KINDRED FITTINGS

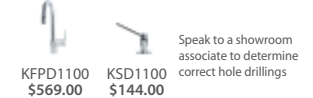

KFPD1100 \$569.00
KSD1100 \$144.00
Speak to a showroom associate to determine correct hole drillings



Sink model QDL2031/8 shown with CA1W colander, MB1610 cutting board and KFPD3100 faucet.

Kindred Steel Queen Topmount

A POPULAR CHOICE FOR VALUE AND VARIETY

Topmount sinks are a traditional and popular choice for kitchens. And the Kindred Steel Queen topmount models set the standard, in robust 20 gauge stainless steel, satin finished bowls with mirror finished rims. Select a single, double or combination model with 7" and 8" deep bowls to address wash up or food prep areas.

And that's not all. We also offer a whole host of optional accessories specifically engineered to make your sink do more for you every day, whether you are chopping, rinsing, defrosting, or draining dishes.

Steel Queen topmount sinks offer good value and a variety of size and bowl configurations, all backed with our standard **Kindred Lifetime Warranty**.

STEEL QUEEN KITCHEN SINKS • TOPMOUNT SERIES • 20 GAUGE, 18-8 STAINLESS STEEL

QDL2031/8

\$529.00



Topmount model



Shipping Weight 18.7 lbs. (8.5 kg.)

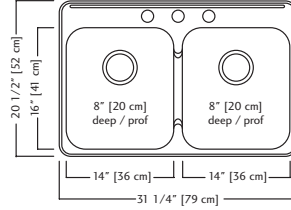

Outside sink rim dimensions 20 1/2" FB x 31 1/4" LR
Equal size bowl dimensions 16" FB x 14" LR x 8" DP

Rear drain wastehole locations, faucet ledge, Spillway® partition

Standard drilling: QDL2031/8/3 - 3 hole - 1 1/2" dia., 4" center-to-center

FUN# 101.0045.182

Optional drilling: QDL2031/8/4 - 4 hole - 4th hole on right hand side

FUN# 101.0045.183

Optional drilling: QDL2031/8/1 - 1 hole - 1 hole on center

FUN# 101.0045.180

33" cabinet - recommended minimum

OPTIONAL ACCESSORIES



BG105 \$127.00 BG105 \$127.00 MB1610 \$89.00 CA1W \$55.00 DBR105 \$140.00 C305 \$125.00

SUGGESTED KINDRED FITTINGS



KFPD1100 \$569.00 KSD1100 \$144.00

Speak to a showroom associate to determine correct hole drillings

QDL2031/7

\$439.00



Topmount model



Shipping Weight 17.6 lbs. (8.0 kg.)

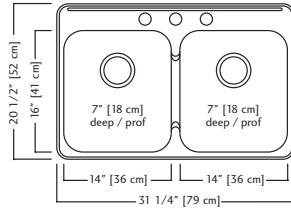

Outside sink rim dimensions 20 1/2" FB x 31 1/4" LR
Equal size bowl dimensions 16" FB x 14" LR x 7" DP

Rear drain wastehole locations, faucet ledge, Spillway® partition

Standard drilling: QDL2031/7/3 - 3 hole - 1 1/2" dia., 4" center-to-center

FUN# 101.0045.177

Optional drilling: QDL2031/7/4 - 4 hole - 4th hole on right hand side

FUN# 101.0045.178

Optional drilling: QDL2031/7/1 - 1 hole - 1 hole on center

FUN# 101.0045.176

33" cabinet - recommended minimum

OPTIONAL ACCESSORIES



BG105 \$127.00 BG105 \$127.00 MB1610 \$89.00 CA1W \$55.00 DBR105 \$140.00 C305 \$125.00

SUGGESTED KINDRED FITTINGS

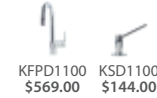

KFPD1100 \$569.00 KSD1100 \$144.00

Speak to a showroom associate to determine correct hole drillings

QD1831/8

\$499.00



Topmount model



Shipping Weight 17.6 lbs. (7.5 kg.)

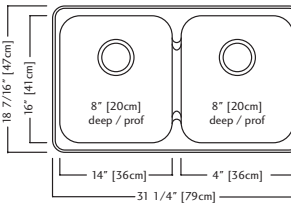

Outside sink rim dimensions 18 7/16" FB x 31 1/4" LR
Equal size bowl dimensions 16" FB x 14" LR x 8" DP

Rear drain wastehole locations, Spillway® partition

Standard drilling: QD1831/8 - no hole

FUN# 101.0045.147

33" cabinet - recommended minimum

OPTIONAL ACCESSORIES



BG105 \$127.00 BG105 \$127.00 MB1610 \$89.00 CA1W \$55.00 DBR105 \$140.00 C305 \$125.00

SUGGESTED KINDRED FITTINGS

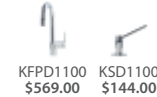

KFPD1100 \$569.00 KSD1100 \$144.00

Speak to a showroom associate to determine correct hole drillings

QDLA2233/8

\$719.00



Topmount model



Shipping Weight 22.4 lbs. (10.2 kg.)

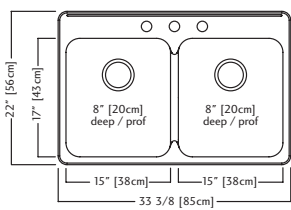

Outside sink rim dimensions 22" FB x 33 3/8" LR
Equal size bowl dimensions 17" FB x 15" LR x 8" DP

Rear drain wastehole locations, faucet ledge, Spillway® partition

Standard drilling: QDLA2233/8/3 - 3 hole - 1 1/2" dia., 4" center-to-center

FUN# 101.0169.265

Optional drilling: QDLA2233/8/1 - 1 hole - 1 hole on center

FUN# 101.0169.264

36" cabinet - recommended minimum

OPTIONAL ACCESSORIES

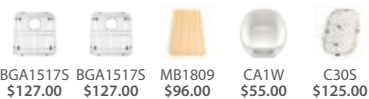

BGA15175 \$127.00 BGA15175 \$127.00 MB1809 \$96.00 CA1W \$55.00 C305 \$125.00

SUGGESTED KINDRED FITTINGS



KFPD1100 \$569.00 KSD1100 \$144.00

Speak to a showroom associate to determine correct hole drillings

STEEL QUEEN KITCHEN SINKS • TOPMOUNT SERIES • 20 GAUGE, 18-8 STAINLESS STEEL

QCMA1826/7

\$509.00



Topmount model

Shipping Weight 15.0 lbs. (6.7 kg.)

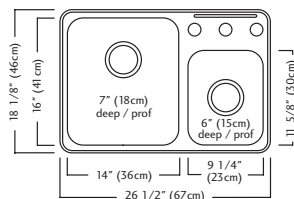

Outside sink rim dimensions 18 1/8" FB x 26 1/2" LR
 Large bowl dimensions 16" FB x 14" LR x 7" DP
 Rear drain wastehole location
 Small bowl dimensions 11 5/8" FB x 9 1/4" LR x 6" DP
 Centre drain wastehole location

Faucet ledge, Spillway® partition

Standard drilling: QCMA1826/7/3 - 3 hole - 1 1/2" dia., 4" center-to-center
FUN# 101.0045.110

Optional drilling: QCMA1826/7/1 - 1 hole - 1 1/2" dia., left hand side
FUN# 101.0203.912

30" cabinet - recommended minimum

OPTIONAL ACCESSORIES

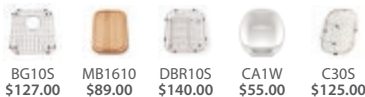

SUGGESTED KINDRED FITTINGS

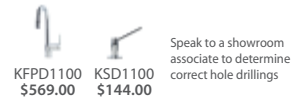

QCLA2031R/8 - as shown

QCLA2031L/8 (small bowl left)

\$739.00



Topmount model

Shipping Weight 17.8 lbs. (8.0 kg.)

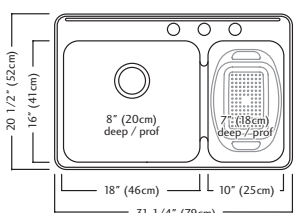

Outside sink rim dimensions 20 1/2" FB x 31 1/4" LR
 Large bowl dimensions 16" FB x 18" LR x 8" DP
 Small bowl dimensions 16" FB x 10" LR x 7" DP

Rear drain wastehole locations, faucet ledge, Spillway® partition

Standard drilling: **QCLA2031R/8/3** - 3 hole - 1 1/2" dia., 4" center-to-center
FUN# 101.0201.838

Optional drilling: **QCLA2031R/8/1** - 1 hole - 1 hole on center
FUN# 101.0201.835

Standard drilling: **QCLA2031L/8/3** - 3 hole - 1 1/2" dia., 4" center-to-center
FUN# 101.0201.844

Optional drilling: **QCLA2031L/8/1** - 1 hole - 1 hole on center
FUN# 101.0201.842

33" cabinet - recommended minimum

OPTIONAL ACCESSORIES



SUGGESTED KINDRED FITTINGS

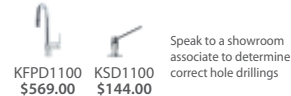

QCLA2027R/8 - as shown

QCLA2027L/8 (small bowl left)

\$709.00



Topmount model

Shipping Weight 15.9 lbs. (7.2 kg.)

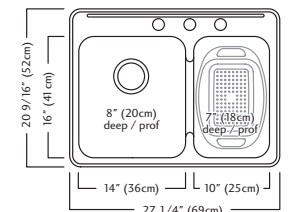

Outside sink rim dimensions 20 9/16" FB x 27 1/4" LR
 Large bowl dimensions 16" FB x 14" LR x 8" DP
 Small bowl dimensions 16" FB x 10" LR x 7" DP

Rear drain wastehole locations, faucet ledge, Spillway® partition

Standard drilling: **QCLA2027R/8/3** - 3 hole - 1 1/2" dia., 4" center-to-center
FUN# 101.0202.031

Optional drilling: **QCLA2027R/8/1** - 1 hole - 1 hole on center
FUN# 101.0202.029

Standard drilling: **QCLA2027L/8/3** - 3 hole - 1 1/2" dia., 4" center-to-center
FUN# 101.0202.172

Optional drilling: **QCLA2027L/8/1** - 1 hole - 1 hole on center
FUN# 101.0202.160

30" cabinet - recommended minimum

OPTIONAL ACCESSORIES



SUGGESTED KINDRED FITTINGS

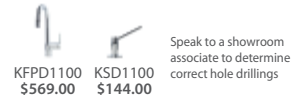

QCM2033/8

\$699.00



Topmount model

Shipping Weight 15.0 lbs. (6.7 kg.)

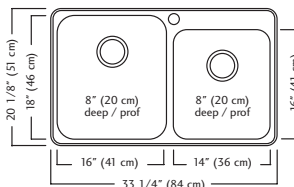

Outside sink rim dimensions 20 1/8" FB x 33 1/4" LR
 Large bowl dimensions 18" FB x 16" LR x 8" DP
 Small bowl dimensions 16" FB x 14" LR x 8" DP

Rear drain wastehole locations, faucet ledge

Optional drilling: QCM2033/8/1 - 1 hole - 1 hole on center
FUN# 101.0062.342

36" cabinet - recommended minimum

OPTIONAL ACCESSORIES



SUGGESTED KINDRED FITTINGS

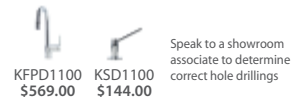

STEEL QUEEN KITCHEN SINKS • TOPMOUNT SERIES • 20 GAUGE, 18-8 STAINLESS STEEL

QSA1816/8

\$309.00



Topmount model



Shipping Weight 7.0 lbs. (3.2 kg.)

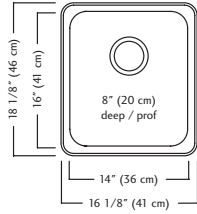

Outside sink dimensions 18 1/8" FB x 16 1/8" LR
Single bowl dimensions 16" FB x 14" LR x 8" DP

Rear drain wastehole location

FUN# 101.0202.339

18" cabinet - recommended minimum

OPTIONAL ACCESSORIES



BG10S \$127.00 MB1610 \$89.00 CA1W \$55.00 DBR10S \$140.00

SUGGESTED KINDRED FITTINGS



KFPD1100 \$569.00 KSD1100 \$144.00
Speak to a showroom associate to determine correct hole drillings

QSLA2217/8

\$399.00



Topmount model



Shipping Weight 12.0 lbs. (5.4 kg.)

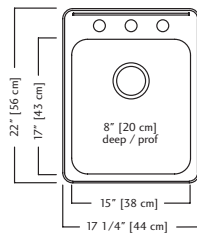

Outside sink dimensions 22" FB x 17 1/4" LR
Single bowl dimensions 17" FB x 15" LR x 8" DP

Rear drain wastehole location

Standard drilling: QSLA2217/8/3 - 3 hole - 1 1/2" dia., 4" center-to-center

FUN# 101.0169.282

Optional drilling: QSLA2217/8/1 - 1 hole on center

FUN# 101.0169.281

21" cabinet - recommended minimum

OPTIONAL ACCESSORIES



BGA1517S \$127.00 MB1809 \$96.00 CA1W \$55.00 DBR10S \$140.00

SUGGESTED KINDRED FITTINGS

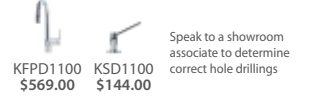

KFPD1100 \$569.00 KSD1100 \$144.00
Speak to a showroom associate to determine correct hole drillings

QSA1820/8

\$319.00



Topmount model



Shipping Weight 11.3 lbs. (5.1 kg.)

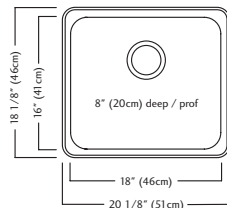

Outside sink dimensions 18 1/8" FB x 20 1/8" LR
Single bowl dimensions 16" FB x 18" LR x 8" DP

Rear drain wastehole location

FUN# 101.0202.331

24" cabinet - recommended minimum

OPTIONAL ACCESSORIES



BG11S \$122.00 MB1610 \$89.00 CA1W \$55.00 DBR10S \$140.00

SUGGESTED KINDRED FITTINGS



KFPD1100 \$569.00 KSD1100 \$144.00
Speak to a showroom associate to determine correct hole drillings

QSA1925/8

\$489.00



Topmount model



Shipping Weight 14.3 lbs. (6.5 kg.)

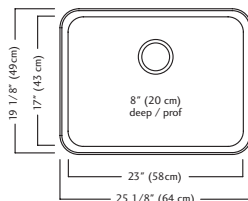

Outside sink dimensions 19 1/8" FB x 25 1/8" LR
Single bowl dimensions 17" FB x 23" LR x 8" DP

Rear drain wastehole location

FUN# 101.0183.342

27" cabinet - recommended minimum

OPTIONAL ACCESSORIES



BGA2317S \$164.00 MB1809 \$96.00 CA1W \$55.00 DBR10S \$140.00

SUGGESTED KINDRED FITTINGS



KFPD1100 \$569.00 KSD1100 \$144.00
Speak to a showroom associate to determine correct hole drillings

STEEL QUEEN KITCHEN SINKS • TOPMOUNT SERIES • 20 GAUGE, 18-8 STAINLESS STEEL

QSL2020/8

\$329.00



Topmount model



Shipping Weight 12.0 lbs. (5.5 kg.)

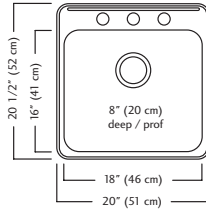

Outside sink rim dimensions 20 1/2" FB x 20" LR
Single bowl dimensions 16" FB x 18" LR x 8" DP

Rear drain wastehole location, faucet ledge

Standard drilling: QSL2020/8/3 - 3 hole - 1 1/2" dia., 4" center-to-center
FUN# 101.0045.230

Optional drilling: QSL2020/8/4 - 4 hole - 4th hole on right hand side
FUN# 101.0045.231

Optional drilling: QSL2020/8/1 - 1 hole - 1 hole on center
FUN# 101.0045.229

24" cabinet - recommended minimum

OPTIONAL ACCESSORIES



BG11S \$122.00 MB1610 \$89.00 CA1W \$55.00 DBR10S \$140.00

SUGGESTED KINDRED FITTINGS

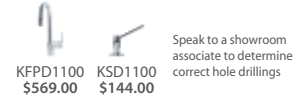

KFPD1100 \$569.00 KSD1100 \$144.00

Speak to a showroom associate to determine correct hole drillings

QSL2020/7

\$254.00



Topmount model



Shipping Weight 11.0 lbs. (4.9 kg.)

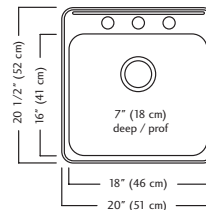

Outside sink rim dimensions 20 1/2" FB x 20" LR
Single bowl dimensions 16" FB x 18" LR x 7" DP

Rear drain wastehole location, faucet ledge

Standard drilling: QSL2020/7/3 - 3 hole - 1 1/2" dia., 4" center-to-center
FUN# 101.0045.226

Optional drilling: QSL2020/7/4 - 4 hole - 4th hole on right hand side
FUN# 101.0045.227

Optional drilling: QSL2020/7/1 - 1 hole - 1 hole on center
FUN# 101.0045.225

24" cabinet - recommended minimum

OPTIONAL ACCESSORIES



BG11S \$122.00 MB1610 \$89.00 CA1W \$55.00 DBR10S \$140.00

SUGGESTED KINDRED FITTINGS

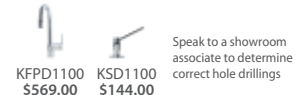

KFPD1100 \$569.00 KSD1100 \$144.00

Speak to a showroom associate to determine correct hole drillings

QSLA2031/8

\$579.00



Topmount model



Shipping Weight 19.5 lbs. (8.8 kg.)

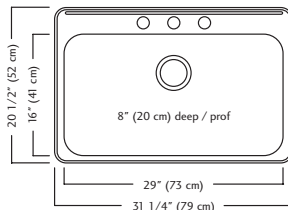

Outside sink rim dimensions 20 1/2" FB x 31 1/4" LR
Single bowl dimensions 16" FB x 29" LR x 8" DP

Rear drain wastehole location, faucet ledge

Standard drilling: QSLA2031/8/3 - 3 hole - 1 1/2" dia., 4" center-to-center
FUN# 101.0202.187

Optional drilling: QSLA2031/8/1 - 1 hole - 1 hole on center
FUN# 101.0202.185

33" cabinet - recommended minimum

OPTIONAL ACCESSORIES



BG240S \$309.00 MB1610 \$89.00 CA1W \$55.00 DBR10S \$140.00

SUGGESTED KINDRED FITTINGS

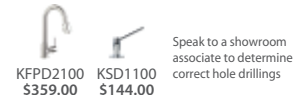

KFPD2100 \$359.00 KSD1100 \$144.00

Speak to a showroom associate to determine correct hole drillings

QSLA2225/8

\$519.00



Topmount model



Shipping Weight 15.2 lbs. (6.9 kg.)

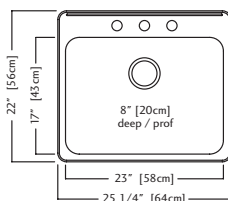

Outside sink rim dimensions 22" FB x 25 1/4" LR
Single bowl dimensions 17" FB x 23" LR x 8" DP

Rear drain wastehole location, faucet ledge

Standard drilling: QSLA2225/8/3 - 3 hole - 1 1/2" dia., 4" center-to-center
FUN# 101.0169.279

Optional drilling: QSLA2225/8/1 - 1 hole - 1 hole on center
FUN# 101.0169.278

27" cabinet - recommended minimum

OPTIONAL ACCESSORIES

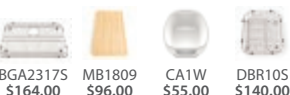

BGA2317S \$164.00 MB1809 \$96.00 CA1W \$55.00 DBR10S \$140.00

SUGGESTED KINDRED FITTINGS

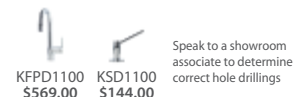

KFPD1100 \$569.00 KSD1100 \$144.00

Speak to a showroom associate to determine correct hole drillings

STEEL QUEEN KITCHEN SINKS • TOPMOUNT SERIES • 20 GAUGE, 18-8 STAINLESS STEEL

QSLA2233/8

\$589.00



Topmount model



Shipping Weight 25.0 lbs. (11.4 kg.)

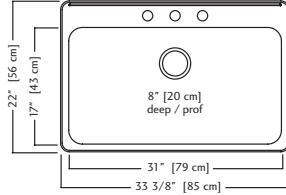

Outside sink rim dimensions 22" FB x 33 3/8" LR
Single bowl dimensions 17" FB x 31" LR x 8" DP

Rear drain wastehole location, faucet ledge

Standard drilling: QSLA2233/8/3 - 3 hole - 1 1/2" dia., 4" center-to-center
FUN# 101.0169.276
Optional drilling: QSLA2233/8/1 - 1 hole - 1 hole on center
FUN# 101.0169.275

36" cabinet - recommended minimum

OPTIONAL ACCESSORIES



BGA31175 \$194.00 MB1809 \$96.00 CA1W \$55.00 DBR105 \$140.00

SUGGESTED KINDRED FITTINGS

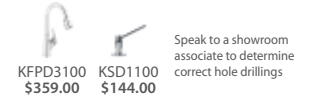

KFPD3100 \$359.00 KSD1100 \$144.00
Speak to a showroom associate to determine correct hole drillings

QCR/8

\$1,169.00



Topmount model



Shipping Weight 18.4 lbs. (8.4 kg.)

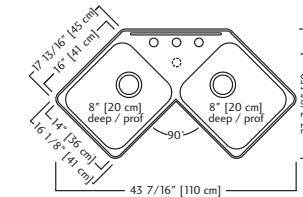

Outside sink dimensions 23 3/8" FB x 43 7/16" LR
Equal size bowl dimensions 16" FB x 14" LR x 8" DP

Rear drain wastehole location

Standard drilling: QCR/8/3 - 3 hole - 1 1/2" dia., 4" center-to-center
FUN# 101.0045.134
Optional drilling: QCR/8/4 - 4 hole - 4 hole, as shown
FUN# 101.0045.135
Optional drilling: QCR/8/1 - 1 hole on center
FUN# 101.0045.133

Corner cabinet application

OPTIONAL ACCESSORIES



BG10S \$127.00 BG10S \$127.00 MB1610 \$89.00 CA1W \$55.00 DBR10S \$140.00

SUGGESTED KINDRED FITTINGS

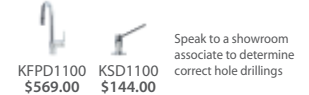

KFPD1100 \$569.00 KSD1100 \$144.00
Speak to a showroom associate to determine correct hole drillings

QTCM1841/8

\$1,249.00



Topmount model



Shipping Weight 21.6 lbs. (9.8 kg.)

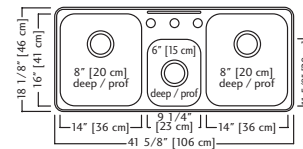

Outside sink dimensions 18 1/8" FB x 41 5/8" LR

Large bowl dimensions 16" FB x 14" LR x 8" DP

Small bowl dimensions 11 5/8" FB x 9 1/4" LR x 6" DP

Rear drain wastehole location

Standard drilling: QTCM1841/8/3 - 3 hole - 1 1/2" dia., 4" center-to-center
FUN# 101.0045.272
Optional drilling: QTCM1841/8/1 - 1 hole on center
FUN# 101.0045.271

45" cabinet - recommended minimum

OPTIONAL ACCESSORIES



BG10S \$127.00 BG10S \$127.00 MB1610 \$89.00 CA1W \$55.00 DBR10S \$140.00

SUGGESTED KINDRED FITTINGS

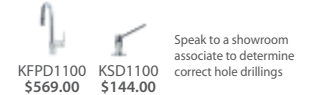

KFPD1100 \$569.00 KSD1100 \$144.00
Speak to a showroom associate to determine correct hole drillings



- 
- 1 Variety of sizes
- 2 20 ga stainless steel
- 3 Easy care finishes
- 4 Grids included

Sink model CDLA2031/8S includes bottom grids. Shown with faucet model KFPOS100.

Cuisinette Accessorized Sinks

SIMPLY PERFECT

When is a sink more than just a sink? When it's an accessorized Cuisinette sink. This unique collection offers added value in both function and finish. The robust 20 gauge stainless steel topmount offering features easy to clean satin finished bowls and silk finished rims for a sparkling centerpiece sink, and sink accessories included right in the sink package.

A variety of bowl shapes, sizes and configurations all with an **easy care finish and accessories included** – what could be simpler?



STEEL QUEEN CUISINETTE ACCESSORIZED TOPMOUNT SINKS • 20 GAUGE, 18-8 STAINLESS STEEL

CDLA2031/8S

\$719.00



Topmount model

Shipping Weight 18.7 lbs. (8.5 kg.)

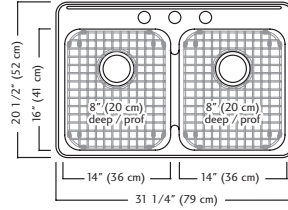

Outside sink dimensions 20 1/2" FB x 31 1/4" LR
 Equal size bowl dimensions 16" FB x 14" LR x 8" DP
 Rear drain wastehole location, faucet ledge and Spillway® partition
 Standard drilling: CDLA2031/8S/3 - 3 hole - 1 1/2" dia., 4" center-to center
FUN# 101.0202.193
 Optional drilling: CDLA2031/8S/1 - 1 hole on center
FUN# 101.0202.191

33" cabinet - recommended minimum

OPTIONAL ACCESSORIES

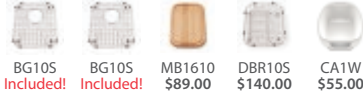

SUGGESTED KINDRED FITTINGS

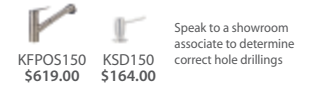

CDC2031R/8S

\$759.00



Topmount model

Shipping Weight 25.5 lbs. (11.6 kg.)

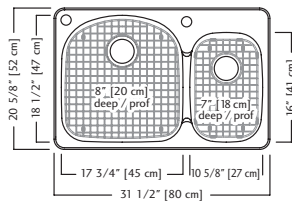

Outside sink dimensions 20 5/8" FB x 31 1/2" LR
 Large bowl - 18 1/2" FB x 17 3/4" LR x 8" DP
 Small bowl - 16" FB x 10 5/8" LR x 7" DP
 Rear drain wastehole location, faucet ledge and Spillway® partition
 Standard drilling: CDC2031R/8S/1 - 1 hole on center, 1 1/2" dia.
FUN# 101.0062.321
 Optional drilling: CDC2031R/8S/2 - 2nd hole, left
FUN# 101.0062.322

33" cabinet - recommended minimum

OPTIONAL ACCESSORIES

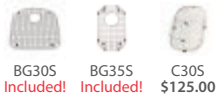

SUGGESTED KINDRED FITTINGS

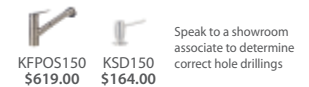

CDC2031L/8S

\$759.00



Topmount model

Shipping Weight 25.5 lbs. (11.6 kg.)

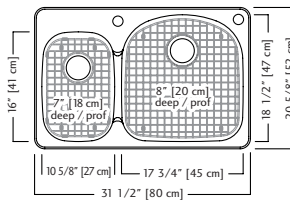

Outside sink dimensions 20 5/8" FB x 31 1/2" LR
 Large bowl - 18 1/2" FB x 17 3/4" LR x 8" DP
 Small bowl - 16" FB x 10 5/8" LR x 7" DP
 Rear drain wastehole location, faucet ledge and Spillway® partition
 Standard drilling: CDC2031L/8S/1 - 1 hole on center, 1 1/2" dia.
FUN# 101.0062.324
 Optional drilling: CDC2031R/8S/2 - 2nd hole, right
FUN# 101.0062.325

33" cabinet - recommended minimum

OPTIONAL ACCESSORIES



SUGGESTED KINDRED FITTINGS

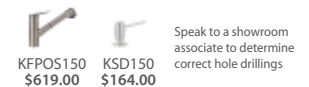

CCLA2027R/8S

\$769.00



Topmount model

Shipping Weight 16.1 lbs. (7.3 kg.)

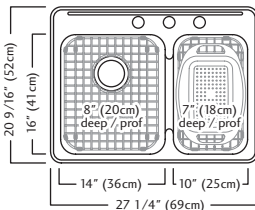

Outside sink dimensions 20 9/16" FB x 27 1/4" LR
 Large bowl - 16" FB x 14" LR x 8" DP
 Small bowl - 16" FB x 10" LR x 7" DP
 Rear drain wastehole location, faucet ledge and Spillway® partition
 Standard drilling: CCLA2027R/8S/3 - 3 hole - 1 1/2" dia., 4" center-to-center
FUN# 101.0202.199
 Optional drilling: CCLA2027R/8S/1 - 1 hole on center
FUN# 101.0202.197

30" cabinet - recommended minimum

OPTIONAL ACCESSORIES



SUGGESTED KINDRED FITTINGS

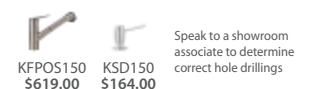

STEEL QUEEN CUISINETTE ACCESSORIZED TOPMOUNT SINKS • 20 GAUGE, 18-8 STAINLESS STEEL

CSLA2020/8S

\$429.00



Topmount model

Shipping Weight 12.0 lbs. (5.5 kg.)

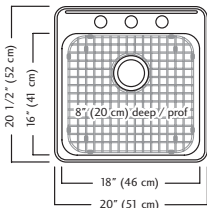

Outside sink dimensions 20 1/2" FB x 20" LR
Single bowl dimensions 16" FB x 18" LR x 8" DP

Rear drain wastehole location

Standard drilling: CSLA2020/8S/3 - 3 hole - 1 1/2" dia., 4" center-to-center
FUN# 101.0202.308

Optional drilling: CSLA2020/8S/1 - 1 hole on center
FUN# 101.0202.245

24" cabinet - recommended minimum

OPTIONAL ACCESSORIES



SUGGESTED KINDRED FITTINGS

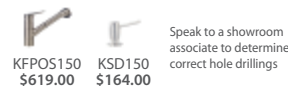

CSX2123/8S

\$509.00



Topmount model

Shipping Weight 19.2 lbs. (8.7 kg.)

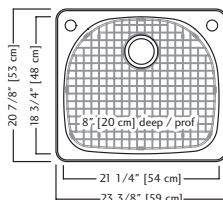

Outside sink dimensions 20 7/8" FB x 23 3/8" LR
Single bowl dimensions 18 3/4" FB x 21 1/4" LR x 8" DP

Rear drain wastehole location

Standard drilling: CSX2123/8S/1R - 1 hole (right), 1 1/2" diameter
FUN# 101.0062.336

Optional drilling: CSX2123/8S/1L - 1 hole (left), 1 1/2" diameter
FUN# 101.0062.337

Optional drilling: CSX2123/8S/2 - 2 hole, as shown
FUN# 101.0062.338

27" cabinet - recommended minimum

OPTIONAL ACCESSORIES



SUGGESTED KINDRED FITTINGS

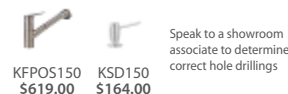



- 
- 1 Rear drains
- 2 Generous 7" and 8" deep bowls
- 3 20 ga stainless steel
- 4 Waste fittings included

Sink model QTU1842/8 shown with faucet model KF10A.

Kindred Steel Queen Undermount Sinks

VALUE AND DURABILITY

An undermount sink is a sparkling companion to a solid surface kitchen countertop. Steel Queen undermount models are available in single, double and combination models for kitchen, laundry and hospitality use.

Wherever you need a durable, dependable sink that keeps its shine year after year the Steel Queen Undermount delivers. This collection includes sink bowls in either **7 or 8 inch depth with a satin finish and decks done with a silk finish.**

All Steel Queen undermount models are shipped ready to install with everything you need including template and instructions – and of course the standard Kindred Lifetime Warranty.

STEEL QUEEN UNDERMOUNT KITCHEN SINKS • 20 GAUGE, 18-8 STAINLESS STEEL

QDUA1933/8

\$599.00



Undermount model

Shipping Weight 17.2 lbs. (7.8 kg.)

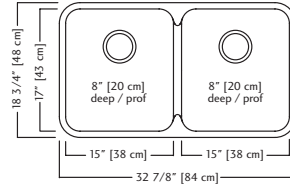

Outside sink dimensions 18 3/4" FB x 32 7/8" LR
Equal size bowl dimensions 17" FB x 15" LR x 8" DP

Rear drain wastehole location and Spillway® partition

FUN# 122.0170.394

33" cabinet - recommended minimum

OPTIONAL ACCESSORIES



BGA15175 \$127.00 BGA15175 \$127.00 MB100 \$214.00 CA1W \$55.00 DBR105 \$140.00

SUGGESTED KINDRED FITTINGS

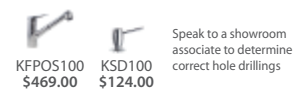

KFPOS100 \$469.00 KSD100 \$124.00
Speak to a showroom associate to determine correct hole drillings

QDUA1831/8

\$529.00



Undermount model

Shipping Weight 17.1 lbs. (7.8 kg.)

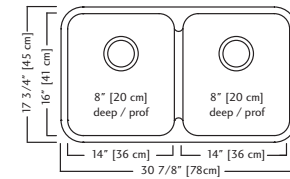

Outside sink dimensions 17 3/4" FB x 30 7/8" LR
Equal size bowl dimensions 16" FB x 14" LR x 8" DP

Rear drain wastehole location Spillway® partition

FUN# 122.0045.191

33" cabinet - recommended minimum

OPTIONAL ACCESSORIES



BG105 \$127.00 BG105 \$127.00 MB100 \$214.00 CA1W \$55.00 DBR105 \$140.00

SUGGESTED KINDRED FITTINGS

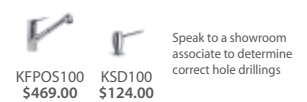

KFPOS100 \$469.00 KSD100 \$124.00
Speak to a showroom associate to determine correct hole drillings

QCUA1933R/8

\$779.00



Undermount model

Shipping Weight 17.2 lbs. (7.8 kg.)

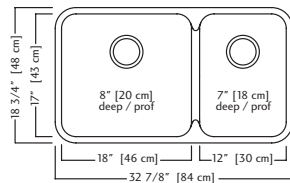

Outside sink dimensions 18 3/4" FB x 32 7/8" LR
Large bowl dimensions 17" FB x 18" LR x 8" DP
Small bowl dimensions 17" FB x 12" LR x 7" DP

Rear drain wastehole location and Spillway® partition

FUN# 122.0170.396

33" cabinet - recommended minimum

OPTIONAL ACCESSORIES



BGA18175 \$142.00 BGA12175 \$96.00 MB100 \$214.00 CA1W \$55.00 DBR105 \$140.00

SUGGESTED KINDRED FITTINGS

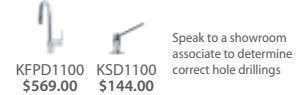

KFPD1100 \$569.00 KSD1100 \$144.00
Speak to a showroom associate to determine correct hole drillings

QCUA1831R/8 - as shown QCUA1831L/8 (small bowl left)

\$719.00



Undermount model

Shipping Weight 17.0 lbs. (7.7 kg.)

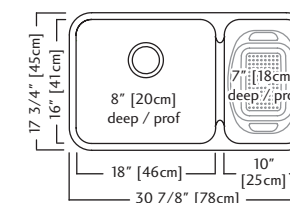

Outside sink dimensions 17 3/4" FB x 30 7/8" LR
Large bowl dimensions 16" FB x 18" LR x 8" DP
Small bowl dimensions 16" FB x 10" LR x 7" DP

Rear drain wastehole location and Spillway® partition

QCUA1831R/8 FUN# 122.0202.322

QCUA1831L/8 FUN# 122.0202.324

33" cabinet - recommended minimum

OPTIONAL ACCESSORIES



CA1W Included! BG115 \$122.00 BG135 \$115.00 MB100 \$214.00 DBR105 \$140.00

SUGGESTED KINDRED FITTINGS

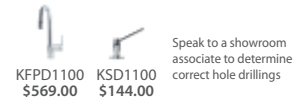

KFPD1100 \$569.00 KSD1100 \$144.00
Speak to a showroom associate to determine correct hole drillings

STEEL QUEEN UNDERMOUNT KITCHEN SINKS • 20 GAUGE, 18-8 STAINLESS STEEL

QCUA1827R/8 - as shown
QCUA1827L/8 (small bowl left)
\$649.00



Undermount model
 Shipping Weight 17.0 lbs. (7.7 kg.)

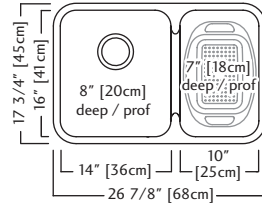

Outside sink dimensions 17 3/4" FB x 26 7/8" LR
 Large bowl dimensions 16" FB x 14" LR x 8" DP
 Small bowl dimensions 16" FB x 10" LR x 7" DP
 Rear drain wastehole location and Spillway® partition

QCUA1827R/8 FUN# 122.0202.327
QCUA1827L/8 FUN# 122.0202.329

30" cabinet - recommended minimum

OPTIONAL ACCESSORIES



SUGGESTED KINDRED FITTINGS

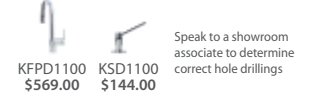

QDCU2031R/8
\$759.00



Undermount model
 Shipping Weight 26.0 lbs. (11.7 kg.)

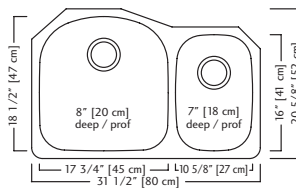

Outside sink dimensions 20 5/8" FB x 31 1/2" LR
 Large bowl dimensions 18 1/2" FB x 17 3/4" LR x 8" DP
 Small bowl dimensions 16" FB x 10 5/8" LR x 7" DP

Rear drain wastehole location

QDCU2031R/8 FUN# 122.0062.239

33" cabinet - recommended minimum

OPTIONAL ACCESSORIES



SUGGESTED KINDRED FITTINGS

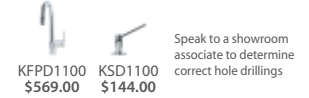

QCMU2029R/8
\$709.00



Undermount model
 Shipping Weight 15.0 lbs. (6.7 kg.)

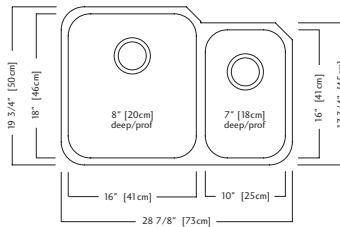

Outside sink dimensions 19 3/4" FB x 28 7/8" LR
 Large bowl dimensions 18" FB x 16" LR x 8" DP
 Small bowl dimensions 16" FB x 10" LR x 7" DP

Rear drain wastehole location

FUN# 122.0305.302

30" cabinet - recommended minimum

OPTIONAL ACCESSORIES

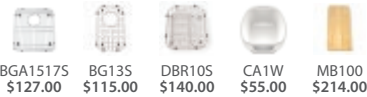

SUGGESTED KINDRED FITTINGS

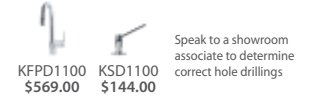

QTU1842/8
\$1,039.00



Undermount model
 Shipping Weight 21.0 lbs. (9.5 kg.)

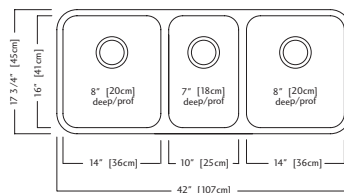

Outside sink dimensions 17 3/4" FB x 42" LR
 Large bowl dimensions 16" FB x 14" LR x 8" DP
 Small bowl dimensions 16" FB x 10" LR x 7" DP

Rear drain wastehole location

FUN# 122.0305.299

42" cabinet - recommended minimum

OPTIONAL ACCESSORIES



SUGGESTED KINDRED FITTINGS

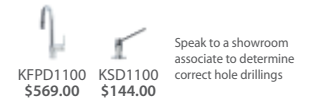

STEEL QUEEN UNDERMOUNT KITCHEN SINKS • 20 GAUGE, 18-8 STAINLESS STEEL

QSUA1933/8

\$539.00



Undermount model



Shipping Weight 19.6 lbs. (8.9 kg.)

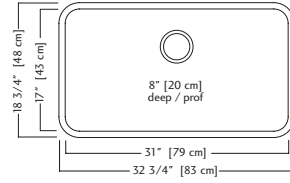

Outside sink dimensions 18 3/4" FB x 32 3/4" LR

Single bowl dimensions 17" FB x 31" LR x 8" DP

Rear drain wastehole location

FUN# 122.0170.398

33" cabinet - recommended minimum

OPTIONAL ACCESSORIES



BGA3117S \$194.00 MB100 \$214.00 CA1W \$55.00 DBR10S \$140.00

SUGGESTED KINDRED FITTINGS



KFPD1100 \$569.00 KSD1100 \$144.00

Speak to a showroom associate to determine correct hole drillings

QSUA1925/8

\$489.00



Undermount model



Shipping Weight 15.7 lbs. (7.1 kg.)

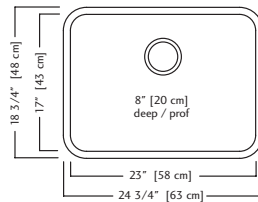

Outside sink dimensions 18 3/4" FB x 24 3/4" LR

Single bowl dimensions 17" FB x 23" LR x 8" DP

Rear drain wastehole location

FUN# 122.0170.399

27" cabinet - recommended minimum

OPTIONAL ACCESSORIES



BGA2317S \$164.00 MB100 \$214.00 CA1W \$55.00 DBR10S \$140.00

SUGGESTED KINDRED FITTINGS



KFPD1100 \$569.00 KSD1100 \$144.00

Speak to a showroom associate to determine correct hole drillings

QSUA1922/8

\$459.00



Undermount model



Shipping Weight 13.0 lbs. (5.9 kg.)

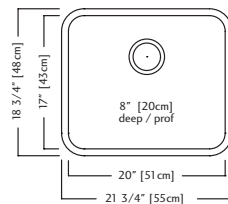

Outside sink dimensions 18 3/4" FB x 21 3/4" LR

Single bowl dimensions 17" FB x 21 3/4" LR x 8" DP

Rear drain wastehole location

FUN# 122.0486.890

24" cabinet - recommended minimum

OPTIONAL ACCESSORIES



BG14S \$127.00 MB100 \$214.00 CA1W \$55.00 DBR10S \$140.00

SUGGESTED KINDRED FITTINGS



KFPD1100 \$569.00 KSD1100 \$144.00

Speak to a showroom associate to determine correct hole drillings

QSUA1831/8

\$499.00



Undermount model



Shipping Weight 19.5 lbs. (8.8 kg.)

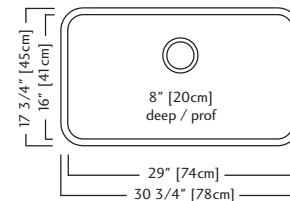

Outside sink dimensions 17 3/4" FB x 30 3/4" LR

Single bowl dimensions 16" FB x 29" LR x 8" DP

Rear drain wastehole location

FUN# 122.0045.257

33" cabinet - recommended minimum

OPTIONAL ACCESSORIES



BG240S \$309.00 MB100 \$214.00 CA1W \$55.00 DBR10S \$140.00

SUGGESTED KINDRED FITTINGS



KFPD1100 \$569.00 KSD1100 \$144.00

Speak to a showroom associate to determine correct hole drillings

STEEL QUEEN UNDERMOUNT KITCHEN SINKS • 20 GAUGE, 18-8 STAINLESS STEEL

QSUA1820/8

\$309.00



OPTIONAL ACCESSORIES



MB100 \$214.00
BG115 \$122.00
CA1W \$55.00
DBR105 \$140.00

Undermount model

Shipping Weight 11.3 lbs. (5.1 kg.)

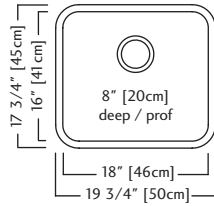

Outside sink dimensions 17 3/4" FB x 19 3/4" LR
Single bowl dimensions 16" FB x 18" LR x 8" DP

Rear drain wastehole location

FUN# 122.0202.333

21" cabinet - recommended minimum

SUGGESTED KINDRED FITTINGS



KFPD1100 \$569.00
KSD1100 \$144.00

Speak to a showroom associate to determine correct hole drillings

QSU1820/10

\$549.00



OPTIONAL ACCESSORIES



MB100 \$214.00
BG1105 \$164.00

Undermount model

Shipping Weight 13.0 lbs. (5.8 kg.)

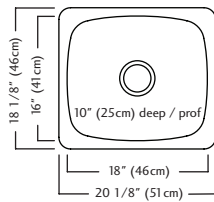

Outside sink dimensions 18 1/8" FB x 20 1/8" LR
Single bowl dimensions 16" FB x 18" LR x 10" DP

Rear drain wastehole location

FUN# 122.0202.337

21" cabinet - recommended minimum

SUGGESTED KINDRED FITTINGS

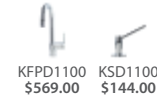

KFPD1100 \$569.00
KSD1100 \$144.00

Speak to a showroom associate to determine correct hole drillings

QXSU2123/8

\$429.00



OPTIONAL ACCESSORIES



MB100 \$214.00
BG205 \$132.00

Undermount model

Shipping Weight 19.2 lbs. (8.7 kg.)

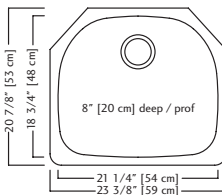

Outside sink dimensions 20 7/8" FB x 23 3/8" LR
Single bowl dimensions 18 3/4" FB x 21 1/4" LR x 8" DP

Rear drain wastehole location

FUN# 122.0062.281

24" cabinet - recommended minimum

SUGGESTED KINDRED FITTINGS



KFPD1100 \$569.00
KSD1100 \$144.00

Speak to a showroom associate to determine correct hole drillings

QSUA1917/8

\$409.00



OPTIONAL ACCESSORIES



BGA1517S \$127.00
MB100 \$214.00
CA1W \$55.00
DBR105 \$140.00

Undermount model

Shipping Weight 12.0 lbs. (5.3 kg.)

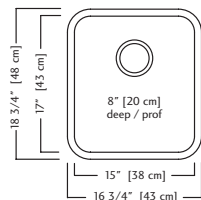

Outside sink dimensions 18 3/4" FB x 16 3/4" LR
Single bowl dimensions 17" FB x 15" LR x 8" DP

Rear drain wastehole location

FUN# 122.0170.400

18" cabinet - recommended minimum

SUGGESTED KINDRED FITTINGS



KFPD1100 \$569.00
KSD1100 \$144.00

Speak to a showroom associate to determine correct hole drillings

STEEL QUEEN UNDERMOUNT KITCHEN SINKS • 20 GAUGE, 18-8 STAINLESS STEEL

QSUA1816/8

\$299.00



Undermount model



Shipping Weight 7.0 lbs. (3.2 kg.)

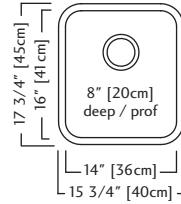

Outside sink dimensions 17 3/4" FB x 15 3/4" LR
Single bowl dimensions 16" FB x 14" LR x 8" DP

Rear drain wastehole location

FUN# 122.0202.335

18" cabinet - recommended minimum

OPTIONAL ACCESSORIES



MB100
\$214.00



BG10S
\$127.00



CA1W
\$55.00



DBR10S
\$140.00

SUGGESTED KINDRED FITTINGS



KFPD1100
\$569.00



KSD1100
\$144.00

Speak to a showroom associate to determine correct hole drillings

QSUA1914/7

\$359.00



Undermount model



Shipping Weight 12.1 lbs. (5.4 kg.)

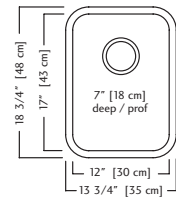

Outside sink dimensions 18 3/4" FB x 13 3/4" LR
Single bowl dimensions 17" FB x 12" LR x 7" DP

Rear drain wastehole location

FUN# 122.0170.401

18" cabinet - recommended minimum

OPTIONAL ACCESSORIES



BGA1217S
\$96.00



MB100
\$214.00



CA1W
\$55.00

SUGGESTED KINDRED FITTINGS



KFPD1100
\$569.00



KSD1100
\$144.00

Speak to a showroom associate to determine correct hole drillings

QSU1614/6

\$299.00



Undermount model



Shipping Weight 6.7 lbs. (3.3 kg.)

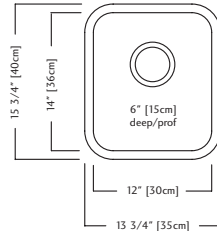

Outside sink dimensions 15 3/4" FB x 13 3/4" LR
Single bowl dimensions 14" FB x 12" LR x 6" DP

Rear drain wastehole location

FUN# 122.0312.101

15" cabinet - recommended minimum

OPTIONAL ACCESSORIES



MB100
\$214.00

SUGGESTED KINDRED FITTINGS



KFPOS100
\$469.00



KSD100
\$124.00

Speak to a showroom associate to determine correct hole drillings

QSUA1616/6

\$309.00



Undermount model



Shipping Weight 6.9 lbs. (3.1 kg.)

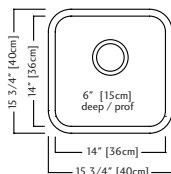

Outside sink dimensions 15 3/4" FB x 15 3/4" LR
Single bowl dimensions 14" FB x 14" LR x 6" DP

Rear drain wastehole location

FUN# 122.0484.875

18" cabinet - recommended minimum

SUGGESTED KINDRED FITTINGS



KFPOS100
\$469.00



KSD100
\$124.00

Speak to a showroom associate to determine correct hole drillings

STEEL QUEEN UNDERMOUNT KITCHEN SINKS • 20 GAUGE, 18-8 STAINLESS STEEL

QSU1812/7
\$274.00



OPTIONAL ACCESSORIES



BG135
 \$115.00



CA1W
 \$55.00



MB100
 \$214.00



Undermount model
 Shipping Weight 6.9 lbs. (3.3 kg.)

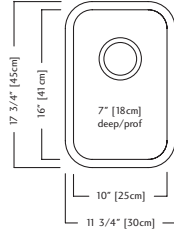

Outside sink dimensions 17 3/4" FB x 11 3/4" LR
 Single bowl dimensions 16" FB x 10" LR x 7" DP
 Rear drain wastehole location
FUN# 122.0312.102

15" cabinet - recommended minimum

SUGGESTED KINDRED FITTINGS



KFPOS100
 \$469.00



KSD100
 \$124.00

Speak to a showroom associate to determine correct hole drillings

QSU1315/6
\$274.00



Undermount model
 Shipping Weight 6.6 lbs. (3.1 kg.)

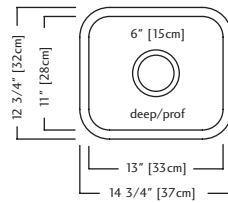

Outside sink dimensions 12 3/4" FB x 14 3/4" LR
 Single bowl dimensions 11" FB x 13" LR x 6" DP
 Centre drain wastehole location
FUN# 122.0311.980

15" cabinet - recommended minimum

SUGGESTED KINDRED FITTINGS



KFPOS100
 \$469.00



KSD100
 \$124.00

Speak to a showroom associate to determine correct hole drillings

QSU1113/6
\$224.00



Undermount model
 Shipping Weight 5.0 lbs. (2.4kg.)

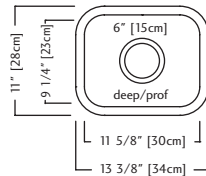

Outside sink dimensions 11" FB x 13 3/8" LR
 Single bowl dimensions 9 1/4" FB x 11 5/8" LR x 6" DP
 Centre drain wastehole location
FUN# 122.0311.979

15" cabinet - recommended minimum

SUGGESTED KINDRED FITTINGS



KFPOS100
 \$469.00



KSD100
 \$124.00

Speak to a showroom associate to determine correct hole drillings



Sink model QSLF2020/12 shown with BGZ18S bottom grid and faucet model KF10A.

Steel Queen Laundry/Hospitality Sinks

A SINK FOR EVERY SITUATION

Let's face it, life is messy. You know what we mean ... The dog needs a bath, garden grime has to be scrubbed off our hands, the dirty coveralls need somewhere to soak before washing. It's a big job and you need a sink that's up to the task.

Well, size matters and Kindred has it. Your laundry room or workshop is just the place for our Steel Queen Specialty Sinks – **big, deep (up to 10")**, some with an overflow, combination sinks, and 'workhorse' models. They're large enough to handle almost anything you throw at (or in) them, and stainless steel durability ensures they still look great at the end of the day.



STEEL QUEEN LAUNDRY SINKS - 20 GAUGE, 18-8 STAINLESS STEEL

QSLF2020/10
\$909.00

cUPC®

Topmount or undermount model
 25 mm radius coved corners
 Shipping Weight 41.1 lbs. (18.3 kg.)

Outside sink dimensions 20 9/16" FB x 20 1/8" LR
 Single bowl dimensions 16" FB x 18" LR x 10" DP
 Rear drain wastehole location, faucet ledge
 Bowl is pitched to the center of the wastehole

#4 commercial satin finished bowls and deck

Standard drilling: QSLF2020/10/3 - 3 hole - 1 1/2" dia., 4" center-to center
FUN# 101.0293.893
 Optional drilling: QSLF2020/10/1 - 1 hole on center
FUN# 101.0300.792

21" cabinet - recommended minimum

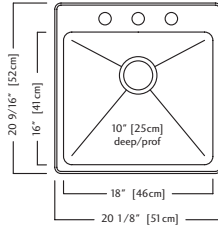

OPTIONAL ACCESSORIES



BGZ18S \$164.00
 DBR10S \$140.00
 MBZ16 \$161.00

SUGGESTED KINDRED FITTINGS

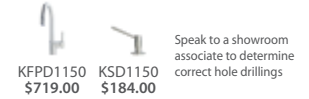

KFPD1150 \$719.00
 KSD1150 \$184.00

Speak to a showroom associate to determine correct hole drillings

QSLF2020/12
\$1,059.00

cUPC®

Topmount or undermount model
 25 mm radius coved corners
 Shipping Weight 41.1 lbs. (18.3 kg.)

Outside sink dimensions 20 9/16" FB x 20 1/8" LR
 Single bowl dimensions 16" FB x 18" LR x 12" DP
 Rear drain wastehole location, faucet ledge
 Bowl is pitched to the center of the wastehole

#4 commercial satin finished bowls and deck

Standard drilling: QSLF2020/10/3 - 3 hole - 1 1/2" dia., 4" center-to center
FUN# 101.0300.898
 Optional drilling: QSLF2020/12/1 - 1 hole on center
FUN# 101.0300.801

21" cabinet - recommended minimum

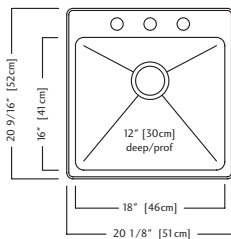

OPTIONAL ACCESSORIES



BGZ18S \$164.00
 DBR10S \$140.00
 MBZ16 \$161.00

SUGGESTED KINDRED FITTINGS

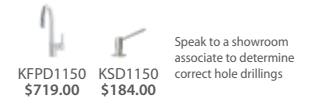

KFPD1150 \$719.00
 KSD1150 \$184.00

Speak to a showroom associate to determine correct hole drillings

QCA1942/10
\$1,239.00

®

Topmount model
 Shipping Weight 25.0 lbs. (11.3 kg.)

Outside sink dimensions 19 3/8" FB x 41 1/2" LR
 Large bowl dimensions 17" FB x 23" LR x 10" DP
 Small bowl dimensions 17" FB x 15" LR x 8" DP

Rear drain wastehole location

Satin bowls, mirror rim

Standard drilling: QCA1942/10 - no hole

45" cabinet - recommended minimum

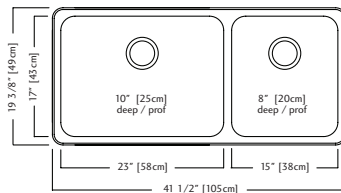

OPTIONAL ACCESSORIES



BGA2317S \$164.00
 BGA1517S \$127.00

SUGGESTED KINDRED FITTINGS

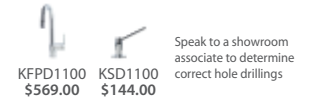

KFPD1100 \$569.00
 KSD1100 \$144.00

Speak to a showroom associate to determine correct hole drillings

QSLA2225/10
\$759.00

®

Topmount model
 Shipping Weight 22.0 lbs. (10.0 kg.)

Outside sink dimensions 22" FB x 25 1/4" LR
 Single bowl dimensions 17" FB x 23" LR x 10" DP
 Center drain wastehole location and faucet ledge

Satin bowls, mirror rim

Standard drilling: QSLA2225/10/3 - 3 hole - 1 1/2" diameter, 4" center-to-center
 Optional drilling: QSLA2225/10/1 - 1 hole - 1 1/2" diameter, on center

27" cabinet - recommended minimum

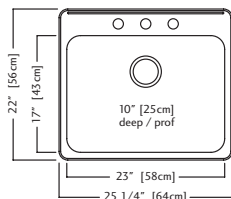

OPTIONAL ACCESSORIES



BGA2317S \$164.00

SUGGESTED KINDRED FITTINGS

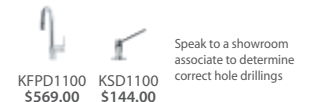

KFPD1100 \$569.00
 KSD1100 \$144.00

Speak to a showroom associate to determine correct hole drillings

STEEL QUEEN LAUNDRY SINKS - 20 GAUGE, 18-8 STAINLESS STEEL

QSL2225/12

\$889.00



Topmount model



Shipping Weight 19.6 lbs. (8.9 kg.)

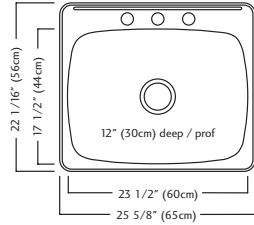

Outside sink dimensions 22 1/16" FB x 25 5/8" LR
Single bowl dimensions 17 1/2" FB x 23 1/2" LR x 12" DP

Center drain wastehole location
Faucet ledge

Standard drilling: QSL2225/12/3 - 3 hole - 1 1/2" diameter, 4" center-to-center

FUN# 113.0045.241

Optional drilling: QSL2225/12/1 - 1 hole on center

27" cabinet - recommended minimum

SUGGESTED KINDRED FITTINGS



Speak to a showroom associate to determine correct hole drillings

QSL2020/10

\$559.00



Topmount model



Shipping Weight 13.2 lbs. (6.0 kg.)

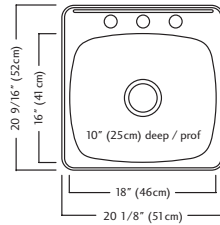

Outside sink dimensions 20 9/16" FB x 20 1/8" LR
Single bowl dimensions 16" FB x 18" LR x 10" DP

Center drain wastehole location and faucet ledge

Standard drilling: QSL2020/10/3 - 3 hole - 1 1/2" diameter, 4" center-to-center

FUN# 113.0045.222

Optional drilling: QSL2020/10/1 - 1 hole on center

FUN# 113.0045.221

24" cabinet - recommended minimum

SUGGESTED KINDRED FITTINGS



Speak to a showroom associate to determine correct hole drillings

OPTIONAL ACCESSORIES



BG1105
\$164.00

QS1820/10

\$539.00



Topmount model



Shipping Weight 13.2 lbs. (6.0 kg.)

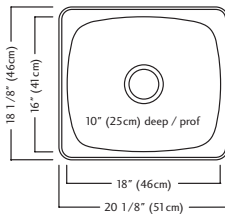

Outside sink dimensions 18 1/8" FB x 20 1/8" LR
Single bowl dimensions 16" FB x 18" LR x 10" DP

Center drain wastehole location

FUN# 113.0045.198

24" cabinet - recommended minimum

SUGGESTED KINDRED FITTINGS



Speak to a showroom associate to determine correct hole drillings

OPTIONAL ACCESSORIES



BG1105
\$164.00

STEEL QUEEN HOSPITALITY SINKS - 20 GAUGE, 18-8 STAINLESS STEEL

QSR18/8
\$599.00



Topmount model
 Shipping Weight 9.9 lbs. (4.5 kg)

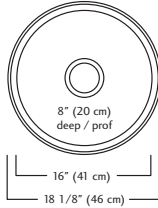

Outside sink dimensions 18 1/8" DIAMETER
 Bowl dimensions 16" DIAMETER x 8" DP
 Center drain wastehole location
FUN# 113.0045.253
21" cabinet - recommended minimum

SUGGESTED KINDRED FITTINGS

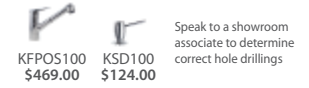

QSL1719/8
\$349.00



Topmount model
 Shipping Weight 12.0 lbs. (5.5 kg)

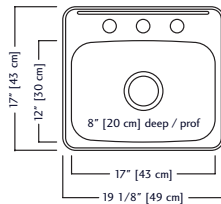

Outside sink dimensions 17" FB x 19 1/8" LR
 Single bowl dimensions 12" FB x 17" LR x 8" DP
 Center drain wastehole location and faucet ledge
 Standard drilling: QSL1719/8/3 - 3 hole - 1 1/2" dia., 4" center-to-center
FUN# 101.0045.215
 Optional drilling: QSL1719/8/1 - 1 hole on center
FUN# 101.0045.213
 Optional drilling: QSL1719/8/2 - 2 hole - 1 1/2" dia., 4" center-to-center
FUN# 101.0045.214
21" cabinet - recommended minimum

SUGGESTED KINDRED FITTINGS

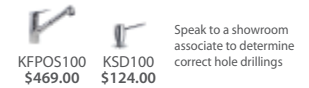

OPTIONAL ACCESSORIES



QSL1515/6
\$284.00



Topmount model
 Shipping Weight 7.0 lbs. (3.2 kg)

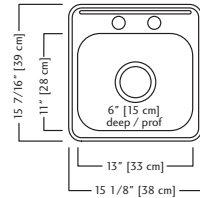

Outside sink dimensions 15 7/16" FB x 15 1/8" LR
 Single bowl dimensions 11" FB x 13" LR x 6" DP
 Center drain wastehole location and faucet ledge
 Standard drilling: QSL1515/6/2 - 2 hole - 1 1/2" diameter, 4" center-to-center
FUN# 113.0045.211
 Optional drilling: QSL1515/6/1 - 1 hole on center
FUN# 113.0045.210
18" cabinet - recommended minimum

SUGGESTED KINDRED FITTINGS



QSL1315/6
\$274.00



Topmount model
 Shipping Weight 6.6 lbs. (3.0 kg)

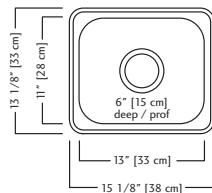

Outside sink dimensions 13 1/8" FB x 15 1/8" LR
 Single bowl dimensions 11" FB x 13" LR x 6" DP
 Center drain wastehole location
FUN# 113.0045.194
18" cabinet - recommended minimum

SUGGESTED KINDRED FITTINGS

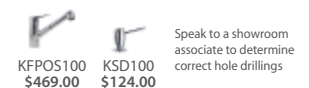

STEEL QUEEN HOSPITALITY SINKS • 20 GAUGE, 18-8 STAINLESS STEEL

QSL1313/6

\$244.00



Topmount model

Shipping Weight 5.4 lbs. (2.4 kg.)

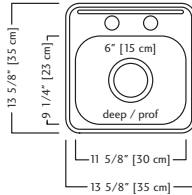

Outside sink dimensions 13 5/8" FB x 13 5/8" LR
Single bowl dimensions 9 1/4" FB x 11 5/8" LR x 6" DP

Center drain wastehole location

Standard drilling: QSL1313/6/2 - 2 hole - 1 1/2" diameter, 4" center-to-center
FUN# 101.0045.208

Optional drilling: QSL1313/6/1 - 1 hole on center
FUN# 101.0045.207

18" cabinet - recommended minimum

SUGGESTED KINDRED FITTINGS



Speak to a showroom associate to determine correct hole drillings

QS1113/6

\$244.00



Topmount model

Shipping Weight 5.0 lbs. (2.3 kg.)

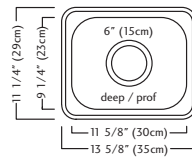

Outside sink dimensions 11 1/4" FB x 13 5/8" LR
Single bowl dimensions 9 1/4" FB x 11 5/8" LR x 6" DP

Center drain wastehole location

FUN# 113.0045.193

18" cabinet - recommended minimum

SUGGESTED KINDRED FITTINGS



Speak to a showroom associate to determine correct hole drillings

QS1614/6

\$309.00



Topmount model

Shipping Weight 6.9 lbs. (3.1 kg.)

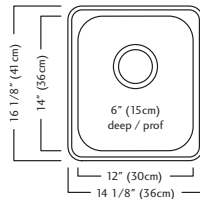

Outside sink dimensions 16 1/8" FB x 14 1/8" LR
Single bowl dimensions 14" FB x 12" LR x 6" DP

Rear drain wastehole location

FUN# 113.0045.195

18" cabinet - recommended minimum

SUGGESTED KINDRED FITTINGS



Speak to a showroom associate to determine correct hole drillings

QSA1616/6

\$329.00



Topmount model

Shipping Weight 7,0 lbs. (3.2 kg.)

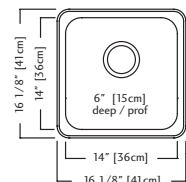

Outside sink dimensions 16 1/8" FB x 16 1/8" LR
Single bowl dimensions 14" FB x 14" LR x 6" DP

Rear drain wastehole location

FUN# 113.0484.871

18" cabinet - recommended minimum

SUGGESTED KINDRED FITTINGS



Speak to a showroom associate to determine correct hole drillings



- 1 Dual spray stream heads
- 2 Long supply hoses
- 3 Smooth single handle operation
- 4 Single hole installation
- 5 Ceramic disc cartridges

Sink model QCLA2027R/8 shown with faucet model KFPD1150.

KINDRED FAUCETS AND FITTINGS

A beautiful addition

We all agree a sink is an essential fixture in every home. In the kitchen it is the nerve center, an integral part of almost every task you do here. Make clean up a breeze with sink accessories such as Kindred Faucet and Soap Dispensers and Kindred Waste Disposers. Simple, sensible solutions.

Kindred offers **Chrome, Satin Nickel and beautiful Color Matched Granite faucets, and soap dispensers in the same finishes for a completely coordinated look.** Beauty and function – superb!

Why choose a Kindred Waste Disposer?

Just ask a plumber, and they will tell you that Kindred is one of the most trusted names in the industry for kitchen sinks, faucets, fittings, and accessories. For more than 60 years plumbing professionals have relied on Kindred for products with legendary performance. And you can too.

Kindred waste disposers continue that fine tradition of Kindred products that offer you superior performance in terms of **reliability, quality, and durability.** Every product that bears the Kindred name will give years of trouble free service, and simplify your life in the kitchen.

Kindred Waste Disposers range from apartment sized 1/3 H.P. models, right up to 1 1/4 H.P. models for big kitchen clean ups. Kindred Bio-Shield waste disposers feature a unique antimicrobial agent, permanently molded in the disposer to eliminate bacteria-caused odors, and Torque Master® balanced turntables and armatures in grinding system for less vibration.

Why choose a Kindred Waste Disposer? Because you can be sure that your life just became simpler.

KINDRED STYLE • FAUCETS

KF10A Commercial Satin Finish **\$509.00** Shipping Weight 7.9 lbs. (3.6 kg.)
cUPC®

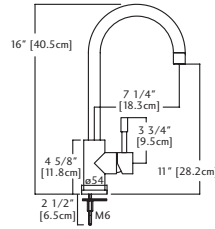

High Arc Stainless Steel Gooseneck Faucet

Commercial satin finish
Solid stainless steel construction
Ceramic disc valve
Flow – aerated stream
3/8" flexible braided hose x 22" long
Requires 1 1/2" diameter hole
Faucet can accommodate a countertop thickness up to 1 1/2"
Water saver faucet rated at 2.2 USGPM, 8.3 L/min.
FUN# 115.0083.703

FINISHES AVAILABLE



Commercial Satin

SUGGESTED KINDRED FITTINGS



KSD100
\$124.00

Speak to a showroom associate to determine correct hole drillings

KF10B Commercial Satin Finish **\$709.00** Shipping Weight 10.4 lbs. (4.7 kg.)
cUPC®

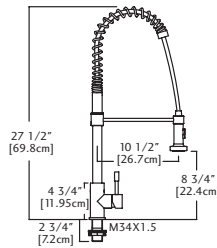

Pro Style Pull Down Stainless Steel Faucet

Commercial satin finish
Solid stainless steel construction
Ceramic disc valve
Flow – aerated stream and spray
3/8" flexible braided hose x 22" long
Requires 1 1/2" diameter hole
Faucet can accommodate a countertop thickness up to 1 1/2"
Water saver faucet rated at 2.2 USGPM, 8.3 L/min.
FUN# 115.0083.792

FINISHES AVAILABLE



Commercial Satin

SUGGESTED KINDRED FITTINGS



KSD10A
\$134.00

Speak to a showroom associate to determine correct hole drillings

KF10C Commercial Satin Finish **\$569.00** Shipping Weight 7.9 lbs. (3.6 kg.)
cUPC®

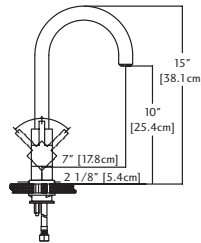

Cube High Arc Stainless Steel Faucet

Commercial satin finish
Solid stainless steel construction
Ceramic disc valve
Flow – aerated stream
3/8" flexible braided hose x 22" long
Requires 1 1/2" diameter hole
Faucet can accommodate a countertop thickness up to 1 1/2"
Water saver faucet rated at 2.2 USGPM, 8.3 L/min.
FUN# 115.0160.249

FINISHES AVAILABLE



Commercial Satin

SUGGESTED KINDRED FITTINGS



KSD10C
\$184.00

Speak to a showroom associate to determine correct hole drillings

PF10A Commercial Satin Finish **\$619.00** Shipping Weight 7.8 lbs. (3.5 kg.)
cUPC®

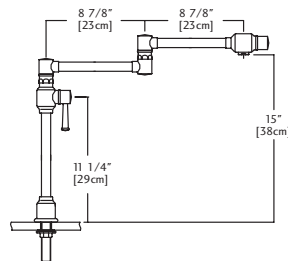

Countertop Mount Stainless Steel Pot Filler Faucet

Commercial satin finish
Solid stainless steel construction
Ceramic disc valve
Flow – aerated stream
3/8" flexible braided hose x 22" long
Requires 7/8" to 1 3/8" diameter hole
Faucet can accommodate a countertop thickness up to 1 1/2"
Water saver faucet rated at 2.2 USGPM, 8.3 L/min.
Single cold supply only
FUN# 115.0202.351

FINISHES AVAILABLE



Commercial Satin

SUGGESTED KINDRED FITTINGS



KSD10A
\$134.00

Speak to a showroom associate to determine correct hole drillings

KINDRED STYLE - FAUCETS

KFPD2100 Chrome Finish **\$359.00** Shipping Weight 7.9 lbs. (3.6 kg)



cUPC®

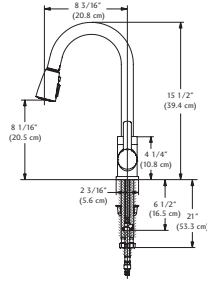

Chrome finish
Brass and polymer construction
Backflow prevention
Spray head extends to 16" long
Dual spray mode (spray or stream)
Requires 1 3/8" diameter hole
Rated at 2.2 USGPM, 8.3 L/min.
Lifetime mechanical warranty
Lifetime warranty on chrome finish

Chrome Finish - FUN# 115.0342.366
Satin Nickel Finish - FUN# 000.0000.000

SUGGESTED KINDRED FITTINGS



Speak to a showroom associate to determine correct hole drillings

FINISHES AVAILABLE



Chrome

KFPD3100 Chrome Finish **\$359.00** Shipping Weight 7.9 lbs. (3.6 kg)



cUPC®

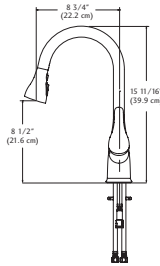

Chrome finish
Brass and polymer construction
Backflow prevention
Spray head extends to 16" long
Dual spray mode (spray or stream)
Requires 1 3/8" diameter hole
Rated at 2.2 USGPM, 8.3 L/min.
Lifetime mechanical warranty
Lifetime warranty on chrome finish

Chrome Finish - FUN# 115.0342.367
Satin Nickel Finish - FUN# 000.0000.000

SUGGESTED KINDRED FITTINGS



Speak to a showroom associate to determine correct hole drillings

FINISHES AVAILABLE



Chrome

Shipping Weight 7.9 lbs. (3.6 kg)



ICC
ES
PMG

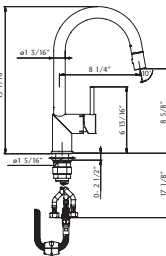

Solid brass construction / Ceramic disc cartridge / Backflow prevention
Spray head extends to 24" long / Dual spray mode (spray or stream)
Requires 1 3/8" diameter hole / Rated at 2.2 USGPM, 8.3 L/min.
Lifetime mechanical warranty / 2 year warranty of decorative finish

KFPD1100	\$569.00	Chrome Finish	FUN# 115.0293.701
KFPD1150	\$719.00	Satin Nickel Finish	FUN# 115.0293.702
KFPD1200	\$659.00	Champagne Finish	FUN# 115.0293.703
KFPD1700	\$659.00	Onyx Finish	FUN# 115.0293.706
KFPD1800	\$659.00	Espresso Finish	FUN# 115.0293.707
KFPD1900	\$659.00	Storm Finish	FUN# 115.0434.564
KFPD2000	\$659.00	Shadow Grey Finish	FUN# 115.0293.705

SUGGESTED KINDRED FITTINGS



Speak to a showroom associate to determine correct hole drillings

FINISHES AVAILABLE

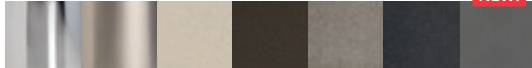

Chrome Satin Nickel CH Champagne ES Espresso SM Storm ON Onyx SG Shadow Grey

NEW!

KFPOS100 Chrome Finish **\$469.00** Shipping Weight 7.9 lbs. (3.6 kg)

Limited Availability

KFPOS150 Satin Nickel Finish **\$619.00**

Limited Availability



cUPC®

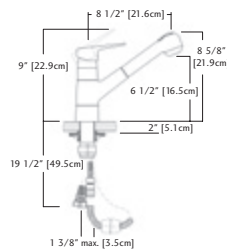

Solid brass construction
Ceramic disc cartridge
Backflow prevention
Spray head extends to 24" long
Dual spray mode (spray or stream)
Requires 1 3/8" diameter hole
Rated at 2.2 USGPM, 8.3 L/min.
Lifetime mechanical warranty
Lifetime warranty on chrome finish
2 year warranty of decorative finish

Chrome Finish - FUN# 115.0152.623
Satin Nickel Finish - FUN# 115.0152.624

SUGGESTED KINDRED FITTINGS



Speak to a showroom associate to determine correct hole drillings

FINISHES AVAILABLE

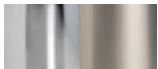

Chrome Satin Nickel

KINDRED STYLE • FAUCET REPLACEMENT PARTS

KFPD REPLACEMENT PARTS

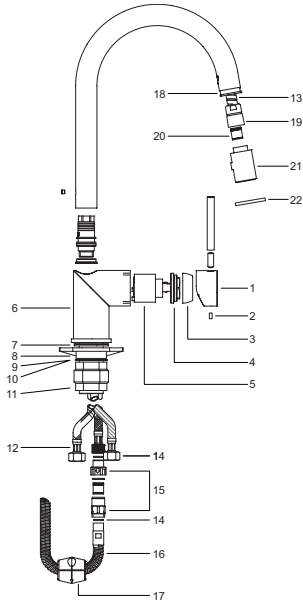

PART #	COMPONENT #	DESCRIPTION	PRICE
SPKHA100	05	Cartridge	\$ 22.00
SPKHA110	14/16	Spray Hose Set, including fiber washer	\$ 72.00
SPKHA121	15	Check Valve Set	\$ 62.00
SPKHA120	20	Flow Regulator	\$ 62.00
SPKHA130	20/21/22	Pull Down Spray Set - Chrome	\$ 154.00
SPKHA131	20/21/22	Pull Down Spray Set - Satin Nickel	\$ 154.00
SPKHA132	20/21/22	Pull Down Spray Set - Champagne	\$ 132.00
SPKHA135	20/21/22	Pull Down Spray Set - Onyx	\$ 132.00
SPKHA136	20/21/22	Pull Down Spray Set - Espresso	\$ 132.00
SPKHA137	20/21/22	Pull Down Spray Set - Storm	\$ 132.00
SPKHA138	20/21/22	Pull Down Spray Set - Shadow Grey	\$ 132.00

KFPOS REPLACEMENT PARTS

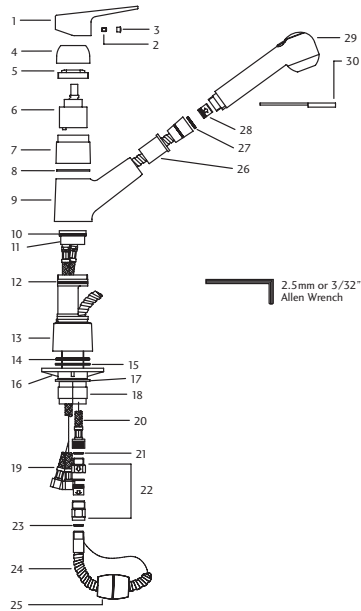

PART #	COMPONENT #	DESCRIPTION	PRICE
SPKHA1	6	Cartridge	\$ 46.00
SPKHA2	21, 24, 27, 33	Spray House Set	\$ 72.00
SPKHA3	1, 2, 3	Handle Set - Chrome	\$ 31.00
SPKHA4	1, 2, 3	Handle Set - Satin Nickel	\$ 37.00
SPKHA5	3, 2	Two Color Screw Cap	\$ 4.30
SPKHA6	27, 21, 23	Washer Set	\$ 4.30
SPKHA7	31	Aerator	\$ 9.60
SPKHA8	30	Tool	\$ 3.20
SPKHA20	28, 29, 30	Pull-Out Spray Head - Chrome	\$ 83.00
SPKHA21	28, 29, 30	Pull-Out Spray Head - Satin Nickel	\$ 117.00
SPKHA40	4	Decorative Cap - Chrome	\$ 18.00
SPKHA40	4	Decorative Cap - Satin Nickel	\$ 23.00
SPKHA60	26	Pull-Out Spray Head Collar	\$ 3.10

KINDRED STYLE - SOAP DISPENSERS

KSD10A Commercial Satin Finish **\$134.00** Shipping Weight 0.8 lbs. (0.3 kg.)

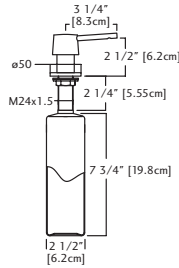

Stainless steel soap and lotion dispenser

Commercial satin finish

Solid stainless steel construction

500ml capacity polypropylene bottle

Soap dispenser requires 1 1/2" diameter hole

Soap dispenser can accommodate a countertop thickness up to 1 1/2"

FUN# 119.0083.793

SUGGESTED KINDRED FITTINGS



KF10A
\$509.00

Speak to a showroom associate to determine correct hole drillings

KSD10C Commercial Satin Finish **\$184.00** Shipping Weight 1.4 lbs. (0.6 kg.)

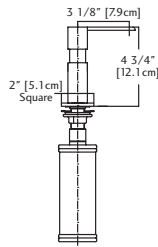

Stainless steel cube style soap and lotion dispenser

Commercial satin finish

Solid stainless steel construction

500ml capacity polypropylene bottle

Soap dispenser requires 1 1/2" diameter hole

Soap dispenser can accommodate a countertop thickness up to 1 1/2"

FUN# 119.0160.246

SUGGESTED KINDRED FITTINGS



KF10C
\$569.00

Speak to a showroom associate to determine correct hole drillings

KSD100 Chrome Finish **\$124.00** Shipping Weight 1.3 lbs. (0.6 kg.)
KSD150 Satin Nickel Finish **\$164.00**

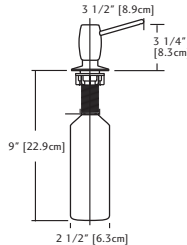

Solid brass construction

Teflon spout line is clog and corrosion resistant

Patented positive prime pump

500ml capacity polypropylene bottle

Requires 1 3/8" diameter hole

Soap dispenser can accommodate a countertop thickness up to 1 1/2"

Lifetime mechanical warranty

2 year warranty of decorative finish

Chrome Finish - FUN# 112.0061.155

Satin Nickel Finish - FUN# 112.0061.156

FINISHES AVAILABLE



Chrome Satin Nickel

SUGGESTED KINDRED FITTINGS



KFPD1100
\$569.00



KFPD1150
\$719.00

Speak to a showroom associate to determine correct hole drillings

Shipping Weight 1.4 lbs. (0.6 kg.)

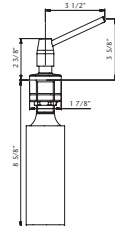

Solid brass construction / Teflon spout line is clog and corrosion resistant

Patented positive prime pump / 500ml capacity polypropylene bottle

Requires 1 3/8" diameter hole / Soap dispenser can accommodate a

countertop thickness up to 1 1/2" / Lifetime mechanical warranty

2 year warranty of decorative finish

KSD1100 \$144.00 Chrome Finish FUN# 112.0293.710

KSD1150 \$184.00 Satin Nickel Finish FUN# 112.0293.709

KSD1200 \$164.00 Champagne Finish FUN# 112.0293.710

KSD1700 \$164.00 Onyx Finish FUN# 112.0293.723

KSD1800 \$164.00 Espresso Finish FUN# 112.0293.724

KSD1900 \$164.00 Storm Finish FUN# 115.0434.565

KSD2000 \$164.00 Shadow Grey Finish FUN# 112.0293.722

FINISHES AVAILABLE

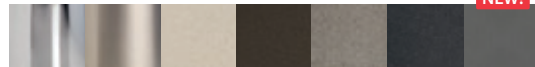

Chrome Satin Nickel CH Champagne ES Espresso SM Storm ON Onyx SG Shadow Grey

NEW!

SUGGESTED KINDRED FITTINGS



KFPD1100
\$569.00



KFPD1150
\$719.00



KFPD1200
\$659.00



KFPD1700
\$659.00



KFPD1800
\$659.00



KFPD1900
\$659.00



KFPD2000
\$659.00

Speak to a showroom associate to determine correct hole drillings

KINDRED · WASTE DISPOSERS

KWD33C1/EZ

\$164.00



OPTIONAL ACCESSORIES



AS200
\$164.00



CONTINUOUS FEED

Shipping Weight 8.7 lbs. (3.9 kg.)

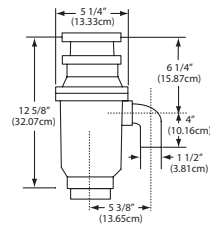

1/3 H.P. motor
High-speed 1925 r.p.m. permanent magnet motor
EZ mount installation system
Stainless steel grinding components
Includes factory installed power cord
Safe for properly sized septic tanks
For use with 110-120 volts/60hz current only
Includes strainer stopper

2 year in-home service warranty



Antimicrobial treatment to inhibit odour



Balanced grinding system to provide long service life & quiet operation

FUN# 134.0255.892

KWD50C1/EZ

\$229.00



OPTIONAL ACCESSORIES



AS200
\$164.00



CONTINUOUS FEED

Shipping Weight 10.6 lbs. (4.8 kg.)

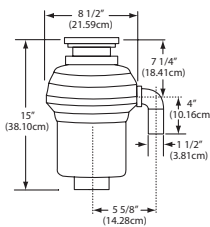

1/2 H.P. motor
High-speed 2700 r.p.m. permanent magnet motor
EZ mount installation system
Stainless steel grinding components
Sound insulated shell
Includes factory installed power cord
Safe for properly sized septic tanks
For use with 110-120 volts/60hz current only
Includes strainer stopper

5 year in-home service warranty



Antimicrobial treatment to inhibit odour



Balanced grinding system to provide long service life & quiet operation

FUN# 134.0255.890

KWD50C2/EZ

\$184.00



OPTIONAL ACCESSORIES



AS200
\$164.00



CONTINUOUS FEED

Shipping Weight 10.6 lbs. (4.8 kg.)

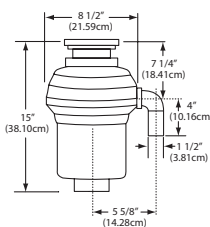

1/2 H.P. motor
High-speed 2700 r.p.m. permanent magnet motor
EZ mount installation system
Stainless steel grinding components
Sound insulated shell
Includes factory installed power cord
Safe for properly sized septic tanks
For use with 110-120 volts/60hz current only
Includes strainer stopper

2 year in-home service warranty



Antimicrobial treatment to inhibit odour



Balanced grinding system to provide long service life & quiet operation

FUN# 134.0262.596

KWD75C1/EZ

\$349.00



OPTIONAL ACCESSORIES



AS200
\$164.00



CONTINUOUS FEED

Shipping Weight 14.0 lbs. (6.3 kg.)

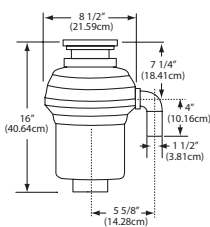

3/4 H.P. motor
High-speed 2700 r.p.m. permanent magnet motor
EZ mount installation system
Stainless steel grinding components
Sound insulated shell
Includes factory installed power cord
Safe for properly sized septic tanks
For use with 110-120 volts/60hz current only
Includes strainer stopper

8 year in-home service warranty



Antimicrobial treatment to inhibit odour



Balanced grinding system to provide long service life & quiet operation

FUN# 134.0255.898

KINDRED • WASTE DISPOSERS

KWD75B1/EZ

\$489.00



BATCH FEED

Shipping Weight 14.0 lbs. (6.3 kg.)

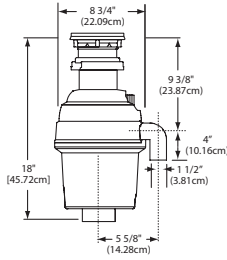

3/4 H.P. motor
 High-speed 2700 r.p.m. permanent magnet motor
 EZ mount installation system
 Stainless steel grinding components
 Sound insulated shell
 Includes factory installed power cord
 Safe for properly sized septic tanks
 For use with 110-120 volts/60hz current only
 Includes strainer stopper

8 year in-home service warranty



Antimicrobial treatment to inhibit odour



Balanced grinding system to provide long service life & quiet operation

FUN# 134.0275.324

KWD125C1/EZ

\$459.00



CONTINUOUS FEED

Shipping Weight 15.0 lbs. (6.8 kg.)

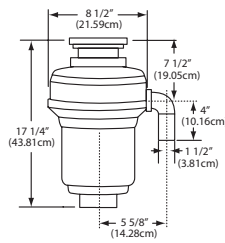

1 1/4 H.P. motor
 High-speed 2800 r.p.m. permanent magnet motor
 EZ mount installation system
 Stainless steel grinding components
 Sound insulated shell
 Includes factory installed power cord
 Safe for properly sized septic tanks
 For use with 110-120 volts/60hz current only
 Includes strainer stopper

10 year in-home service warranty



Antimicrobial treatment to inhibit odour



Balanced grinding system to provide long service life & quiet operation

FUN# 134.0255.899

OPTIONAL ACCESSORIES



AS200
 \$164.00

KWD125B1/EZ

\$619.00



1 1/4 hp - 2800 rpm - BATCH FEED

Shipping Weight 15.0 lbs. (6.8 kg.)

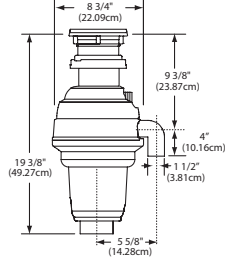

1 1/4 H.P. motor
 High-speed 2800 r.p.m. permanent magnet motor
 EZ mount installation system
 Stainless steel grinding components
 Sound insulated shell
 Includes factory installed power cord
 Safe for properly sized septic tanks
 For use with 110-120 volts/60hz current only
 Includes strainer stopper

10 year in-home service warranty



Antimicrobial treatment to inhibit odour



Balanced grinding system to provide long service life & quiet operation

FUN# 134.0315.656

AS200

\$164.00



Air actuated on/off control

Shipping Weight 1.5 lbs. (0.7 kg.)

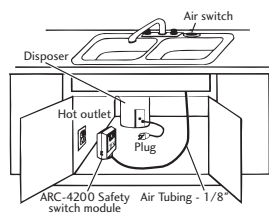

Includes separate chrome and satin nickel finished air switch control buttons
 For use with continuous feed waste disposers
 Can be used with waste disposers up to 1 H.P., 120 V
 Eliminates need for an electrical wall switch
 Installs into existing sink hole drilling, or countertop

FUN# 112.0312.211





















MB1610 cutting board shown.

KINDRED ACCESSORIES







... they just make sense!

Sink accessories such as laminated maple cutting boards, ABS colanders, and stainless wire drainer baskets, and grids simplify the art of preparing a meal. Slice and dice, mince and rinse, drain and strain ... a big sink with room to move, and **sink accessories that are truly functional**, will please even the most temperamental chef. We like to think of Kindred accessories as kitchen helpers. And who couldn't use a little extra help in the kitchen?





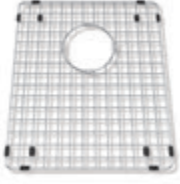
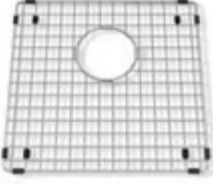
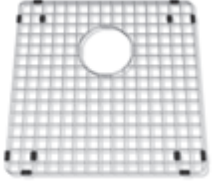
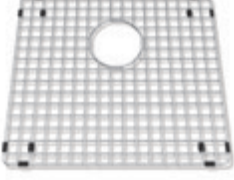
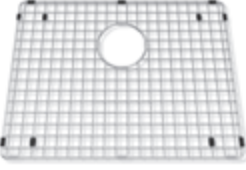
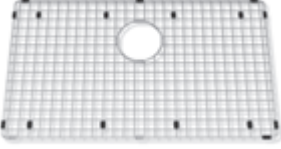
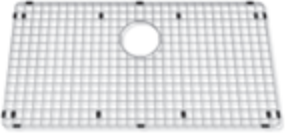
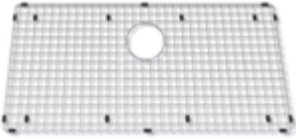
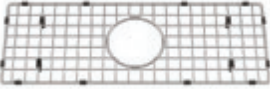
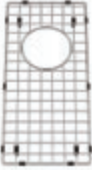
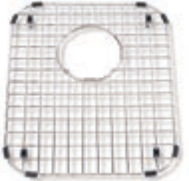

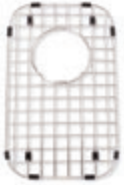
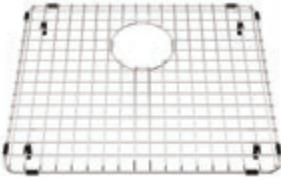
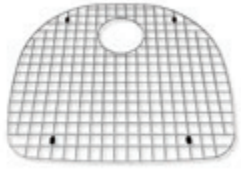

KINDRED • ACCESSORIES

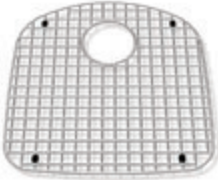
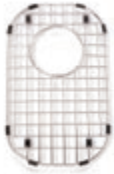
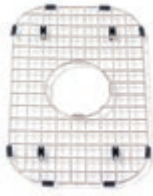
<p>DR1614 \$80.00</p>  <p>Polished stainless steel drain rack Dimensions 10 1/2" FB x 6 1/2" LR x 3 3/4" HIGH FUN#112.0044.802</p>	<p>GB50 \$254.00</p>  <p>Frosted glass board Dimensions 11" FB x 16" LR x 3/4" HIGH FUN#112.0061.448</p>	<p>GB1712M \$164.00</p>  <p>Glass board and color mat set Dimensions 16 7/8" FB x 12" LR x 1/2" HIGH FUN#112.0193.152</p>	<p>MB1809 \$96.00</p>  <p>Laminated maple cutting board Dimensions 18" FB x 9" LR x 1" HIGH FUN# 112.0183.343</p>
<p>MB1610 \$89.00</p>  <p>Laminated maple cutting board Dimensions 16 3/4" FB x 10 1/2" LR x 1" HIGH FUN#112.0061.317</p>	<p>MB1612 \$99.00</p>  <p>Laminated maple cutting board Dimensions 16 7/16" FB x 11 11/16" LR x 1" HIGH FUN#112.0061.142</p>	<p>MB1710 \$110.00</p>  <p>Laminated maple cutting board Dimensions 18" FB x 11" LR x 1" HIGH FUN#112.0061.144</p>	<p>MB20 \$144.00</p>  <p>Laminated maple cutting board Dimensions 19 3/4" FB x 16 1/4" LR x 1" HIGH FUN#112.0061.318</p>
<p>MB50 \$110.00</p>  <p>Laminated maple cutting board Dimensions 15 15/16" FB x 10" LR x 3/4" HIGH FUN#112.0061.146</p>	<p>MB55 \$110.00</p>  <p>Laminated maple cutting board Dimensions 17 9/32" FB x 10" LR x 3/4" HIGH FUN#112.0061.147</p>	<p>MB100 \$214.00</p>  <p>Laminated maple cutting board Dimensions 24 11/16" FB x 11 15/16" LR x 1" HIGH FUN#112.0061.143</p>	<p>MBZ16 \$161.00</p>  <p>Laminated maple cutting board Dimensions 16 3/4" FB x 10 1/2" LR x 1" HIGH FUN#112.0202.530</p>
<p>MBZ17 \$161.00</p>  <p>Laminated maple cutting board Dimensions 17 3/4" FB x 11 1/2" LR x 1" HIGH FUN#112.0202.531</p>	<p>CM100 \$59.00</p>  <p>Color mats Dimensions 11" FB x 8" LR x .06" HIGH FUN#113.0193.751</p>	<p>CA1W \$55.00</p>  <p>White ABS colander Dimensions 13" FB x 9" LR x 4 1/2" DEEP FUN# 112.0202.209</p>	<p>C20S \$112.00</p>  <p>Polished stainless steel mesh colander Dimensions 13 1/4" FB x 6" LR x 2 1/2" DEEP FUN#112.0044.809</p>
<p>C30S \$125.00</p>  <p>Polished stainless steel mesh colander Dimensions 15" FB x 9 1/2" LR x 2 1/2" DEEP FUN#112.0044.810</p>	<p>C50S \$154.00</p>  <p>Brushed stainless steel colander Dimensions 15 11/16" FB x 6 3/16" LR x 2 1/4" DEEP FUN#112.0054.960</p>	<p>C09S \$164.00</p>  <p>Stainless steel colander Dimensions 10 1/8" DIAMETER x 4 1/8" HIGH FUN#112.0352.874</p>	<p>DBR10S \$140.00</p>  <p>Polished stainless steel drainer basket Dimensions 14 5/8" FB x 12" LR x 3" HIGH FUN#112.0044.784</p>



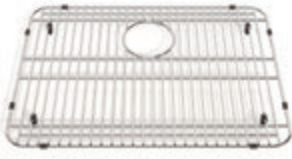

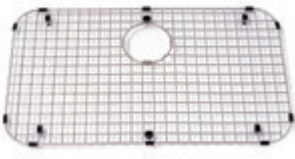
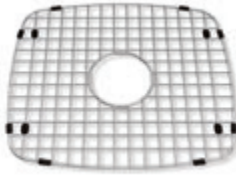

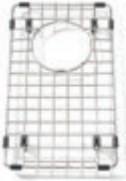
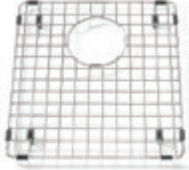
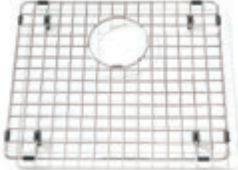
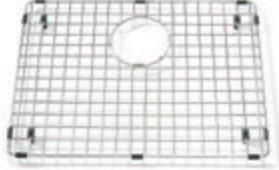
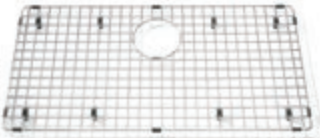
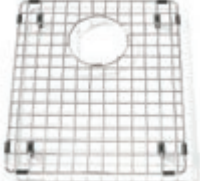
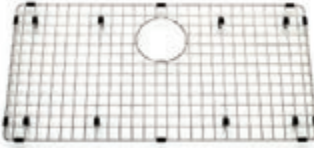
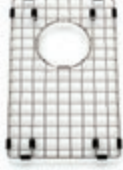



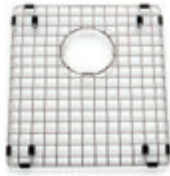
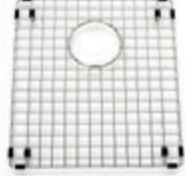
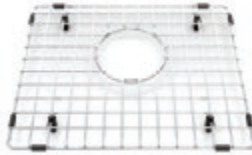





KINDRED • ACCESSORIES

<p>RM50S \$174.00</p>  <p>Polished flexible stainless steel roll mat Dimensions 15 7/8" FB x 13 3/4" LR x 3/8" HIGH FUN# 112.0058.825</p>	<p>RM55S \$174.00</p>  <p>Polished flexible stainless steel roll mat Dimensions 17 1/4" FB x 14 3/8" LR x 3/8" HIGH FUN# 112.0058.824</p>	<p>BGDS10S \$159.00</p>  <p>Polished stainless steel bottom grid Dimensions 15" FB x 9" LR x 1" HIGH FUN#112.0040.602</p>	<p>BGDS11S \$174.00</p>  <p>Polished stainless steel bottom grid Dimensions 15" FB x 10" LR x 1" HIGH FUN#112.0040.601</p>
<p>BGDS13S \$194.00</p>  <p>Polished stainless steel bottom grid Dimensions 15" FB x 12" LR x 1" HIGH FUN#112.0040.599</p>	<p>BGDS14S \$209.00</p>  <p>Polished stainless steel bottom grid Dimensions 15 1/4" FB x 13 1/4" LR x 1" HIGH FUN# 112.0078.322</p>	<p>BGDS15S \$209.00</p>  <p>Polished stainless steel bottom grid Dimensions 14 1/4" FB x 14 1/4" LR x 1" HIGH FUN# 112.0054.949</p>	<p>BGDS16S \$224.00</p>  <p>Polished stainless steel bottom grid Dimensions 15" FB x 15" LR x 1" HIGH FUN#112.0040.600</p>
<p>BGDS18S \$244.00</p>  <p>Polished stainless steel bottom grid Dimensions 15" FB x 17" LR x 1" HIGH FUN#112.0040.596</p>	<p>BGDS21S \$284.00</p>  <p>Polished stainless steel bottom grid Dimensions 15" FB x 20" LR x 1" HIGH FUN#112.0040.598</p>	<p>BGDS27S \$339.00</p>  <p>Polished stainless steel bottom grid Dimensions 15" FB x 26" LR x 1" HIGH FUN#112.0040.597</p>	<p>BGDS30S \$369.00</p>  <p>Polished stainless steel bottom grid Dimensions 15" FB x 29" LR x 1" HIGH FUN#112.0040.595</p>
<p>BGDS33S \$339.00</p>  <p>Polished stainless steel bottom grid Dimensions 15" FB x 32" LR x 1" HIGH FUN#112.0040.594</p>	<p>BGDS22S \$174.00</p>  <p>Polished stainless steel bottom grid Dimensions 7 1/2" FB x 21 3/16" LR x 1" HIGH FUN#112.0275.243</p>	<p>BGDS0817S \$151.00</p>  <p>Polished stainless steel bottom grid Dimensions 16 1/2" FB x 7 1/2" LR x 1" HIGH FUN#112.0275.244</p>	<p>BG10S \$127.00</p>  <p>Polished stainless steel bottom grid Dimensions 14 1/4" FB x 11 7/8" LR x 1" HIGH FUN#112.0044.785</p>
<p>BG11S \$122.00</p>  <p>Polished stainless steel bottom grid Dimensions 14 1/4" FB x 15 1/4" LR x 1" HIGH FUN#112.0044.786</p>	<p>BG13S \$115.00</p>  <p>Polished stainless steel bottom grid Dimensions 14 1/4" FB x 8 1/4" LR x 1" HIGH FUN#112.0055.507</p>	<p>BG14S \$127.00</p>  <p>Polished stainless steel bottom grid Dimensions 15" FB x 18" LR x 1" HIGH FUN#112.0486.240</p>	<p>BG20S \$132.00</p>  <p>Polished stainless steel bottom grid Dimensions 17 1/8" FB x 19 9/16" LR x 1" HIGH FUN#112.0055.434</p>





KINDRED · ACCESSORIES

<p>BG30S \$164.00</p>  <p>Polished stainless steel bottom grid Dimensions 16 7/8" FB x 16 3/16" LR x 1" HIGH FUN#112.0055.435</p>	<p>BG35S \$132.00</p>  <p>Polished stainless steel bottom grid Dimensions 14 1/4" FB x 8 1/2" LR x 1" HIGH FUN#112.0044.796</p>	<p>BG65S \$142.00</p>  <p>Polished stainless steel bottom grid Dimensions 14 3/4" FB x 9 1/2" LR x 1" HIGH FUN#112.0044.791</p>	<p>BGA1217S \$96.00</p>  <p>Polished stainless steel bottom grid Dimensions 15" FB x 10 1/8" LR x 1" HIGH FUN#112.0174.874</p>
<p>BGA1517S \$127.00</p>  <p>Polished stainless steel bottom grid Dimensions 15" FB x 13" LR x 1" HIGH FUN# 112.0174.872</p>	<p>BGA1817S \$142.00</p>  <p>Polished stainless steel bottom grid Dimensions 15" FB x 16" LR x 1" HIGH FUN#112.0174.876</p>	<p>BGA1820S \$164.00</p>  <p>Polished stainless steel bottom grid Dimensions 17 5/8" FB x 16" LR x 1" HIGH FUN# 112.0174.877</p>	<p>BGA2317S \$164.00</p>  <p>Polished stainless steel bottom grid Dimensions 15" FB x 21" LR x 1" HIGH FUN# 112.0174.875</p>
<p>BGA3117S \$194.00</p>  <p>Polished stainless steel bottom grid Dimensions 15" FB x 29" LR x 1" HIGH FUN# 112.0174.878</p>	<p>BG90S \$164.00</p>  <p>Polished stainless steel bottom grid Dimensions 14 5/8" FB x 25 1/4" LR x 1" HIGH FUN#112.0044.794</p>	<p>BG110S \$164.00</p>  <p>Polished stainless steel bottom grid Dimensions 13 7/8" FB x 15 7/8" LR x 1" HIGH FUN#112.0040.526</p>	<p>BG160S \$154.00</p>  <p>Polished stainless steel bottom grid Dimensions 13 5/8" FB x 12 5/16" LR x 1" HIGH FUN#112.0054.981</p>
<p>BG170S \$142.00</p>  <p>Polished stainless steel bottom grid Dimensions 14" FB x 7 3/4" LR x 1" HIGH FUN#112.0054.979</p>	<p>BG180S \$148.00</p>  <p>Polished stainless steel bottom grid Dimensions 13 5/8" FB x 11 7/8" LR x 1" HIGH FUN#112.0055.046</p>	<p>BG190S \$214.00</p>  <p>Polished stainless steel bottom grid Dimensions 13 5/8" FB x 15 3/8" LR x 1" HIGH FUN#112.0055.044</p>	<p>BG200S \$229.00</p>  <p>Polished stainless steel bottom grid Dimensions 13 5/8" FB x 18 1/8" LR x 1" HIGH FUN#112.0055.043</p>
<p>BG210S \$294.00</p>  <p>Polished stainless steel bottom grid Dimensions 13 5/8" FB x 26 11/16" LR x 1" HIGH FUN#112.0055.042</p>	<p>BG220S \$174.00</p>  <p>Polished stainless steel bottom grid Dimensions 14 3/4" FB x 12 5/16" LR x 1" HIGH FUN#112.0055.045</p>	<p>BG240S \$309.00</p>  <p>Polished stainless steel bottom grid Dimensions 14 1/4" FB x 27 1/4" LR x 1" HIGH FUN#112.0204.314</p>	<p>BGZ10S \$142.00</p>  <p>Polished stainless steel bottom grid Dimensions 14 7/8" FB x 8 7/8" LR x 1" HIGH FUN#112.0194.732</p>

KINDRED • ACCESSORIES

<p>BGZ14S \$148.00</p>  <p>Polished stainless steel bottom grid Dimensions 14 7/8" FB x 12 3/4" LR x 1" HIGH FUN#112.0194.703</p>	<p>BGZ15S \$154.00</p>  <p>Polished stainless steel bottom grid Dimensions 16" FB x 13 7/8" LR x 1" HIGH FUN#112.0194.710</p>	<p>BGZ1512S \$142.00</p>  <p>Polished stainless steel bottom grid Dimensions 11 1/8" FB x 13 1/2" LR x 1" HIGH FUN#112.0300.990</p>	<p>BGZ18S \$164.00</p>  <p>Polished stainless steel bottom grid Dimensions 14 7/8" FB x 16 7/8" LR x 1" HIGH FUN#112.0194.709</p>
<p>BGZ23S \$169.00</p>  <p>Polished stainless steel bottom grid Dimensions 16" FB x 21 7/8" LR x 1" HIGH FUN#112.0194.731</p>	<p>61621 \$30.00 61622 (12 pcs) \$329.00</p>  <p>Stainless steel cleaner 61621 - FUN# 112.0061.299 61622 - FUN# 112.0061.300</p>	<p>61411 \$14.50</p>  <p>Sink maintenance kit FUN# 113.0061.298</p>	<p>1135 \$25.00</p>  <p>Stainless strainer assembly FUN# 112.0040.565</p>
<p>1135-CS \$25.00</p>  <p>Stainless strainer assembly in clam shell packaging FUN# 112.0181.283</p>	<p>1135/60 \$1,349.00</p>  <p>Stainless strainer assembly FUN# 112.0061.322</p>	<p>1140 \$26.00</p>  <p>Stainless strainer assembly</p>	<p>1140/60 \$1,376.00</p>  <p>Stainless strainer assembly</p>
<p>1135T \$8.50</p>  <p>Polypropylene tailpiece with rubber gasket FUN # 112.0357.197</p>	<p>1130B \$10.00</p>  <p>Stainless strainer basket FUN# 133.0054.947</p>	<p>1135B \$10.00</p>  <p>Stainless strainer basket Fits 1135 and 1140 strainer FUN# 112.0156.395</p>	<p>1135B-CS \$9.60</p>  <p>Stainless strainer basket in clam shell packaging FUN# 112.0274.796</p>
<p>125GOWK \$62.00</p>  <p>1 1/4" Grid waste drain FUN# 112.0040.553</p>	<p>100 \$19.00</p>  <p>1 1/2" Stainless steel waste fitting with brass tailpiece & rubber stopper FUN# 991.0055.439</p>	<p>1047 \$26.00</p>  <p>Integral Waste Assembly FUN# 134.0367.602</p>	<p>315-9 \$8.50</p>  <p>1 1/2" Brass tailpiece FUN# 991.0055.439</p>

KINDRED • ACCESSORIES

<p>31703 \$2.20</p>  <p>EZ Torque sink fastener FUN# 112.0366.516</p>	<p>EL-CLIPS \$6.40</p>  <p>Undermount installation bracket FUN# 992.0072.153</p>	<p>31548 \$4.30</p>  <p>8 pc. bolt & claw assembly in poly bag FUN# 992.0040.525</p>	<p>20102 \$8.50</p>  <p>Undermount Installation Hardware Kit Kindred undermount hardware requires 3" additional cabinet space FUN#112.0266.494</p>
--	---	--	---

STAINLESS STEEL FINISHES BY KINDRED

We recognize that the appearance and durability of a stainless steel sink is an important part of the sink selection process and overall purchase decision. And this decision will no doubt be influenced by the finish that we apply to the product.

While there are no industry-wide standards, there are some common product finishes offered by sink manufacturers today.

For example:

- We know that a smooth and bright finish will shed water, resist water spotting, and add sparkle to the kitchen. This is a good choice for a sink deck where appearance is important and “wear and tear” is minimal.
- We also know that a grain line or brush finish is a good choice for the sink bowl. This is where the work is done in the kitchen and where a sink must prove it’s mettle ... the sink bowl finish must be durable enough to stand up to whatever you can throw at it.

Kindred has polished and finished stainless steel sinks for over 60 years. That’s a lot of experience and a lot of satisfied customers. This ongoing, never-ending discussion with customers, has led to the development of the following Kindred product finishes:

#4 Commercial Finish - A uniform grain line finish applied to the entire surface of the product.

Silk Finish - A smooth and polished surface created with polishing brushes and polishing compounds.

Mirror Finish - A highly reflective and bright surface created with buffing wheels & compounds.

WARRANTY

RESIDENTIAL SINKS

Kindred brand Stainless Steel and Granite Sinks are guaranteed against defects in material or workmanship, for any normal domestic purpose for which they are intended, for as long as you own your sink.

ACCESSORIES

Kindred brand accessories including hardwood cutting boards, and stainless steel colanders and trays, and baskets and grids are guaranteed against defects in material, and to be suitable for any normal domestic purpose for which they are intended for a period of one year from date of purchase.

FAUCETS

Every Kindred brand (chrome plate or solid stainless) faucet is guaranteed to be suitable for any normal domestic purpose for which it is intended and without defects in material or workmanship for as long as the original purchaser owns their home, provided it has been installed and maintained according to Franke Kindred Canada Limited instructions. The only exception to this warranty shall be decorative faucet finish which shall be warranted for a period of two years from date of purchase.

WASTE DISPOSERS (See pages 68-69)

For more detailed information regarding all Kindred warranties please review the information at www.kindredcanada.com

QUICK FIND GUIDE

SINKS

Model	Price	Page	Model	Price	Page	Model	Price	Page
CCLA2027R/8S	\$ 769.00	48	KSOV1418/7	\$ 349.00	25	QSA1816/8	\$ 309.00	44
CDC2031L/8S	\$ 759.00	48	KSOV1420U/7	\$ 599.00	23	QSA1820/8	\$ 319.00	44
CDC2031R/8S	\$ 759.00	48	KSOV1619/7	\$ 359.00	25	QSA1925/8	\$ 489.00	44
CDLA2031/8S	\$ 719.00	48	KSOV16U/7	\$ 419.00	24	QSF531B	\$ 1,159.00	36
CSLA2020/8S	\$ 429.00	49	KSOV17/7	\$ 339.00	25	QSFU1820/8	\$ 459.00	40
CSX2123/8S	\$ 509.00	49	KSOV1821/7	\$ 409.00	25	QSFU1925/8	\$ 509.00	40
KCC33R/9-10A	\$ 1,949.00	11	KSOV18U/7	\$ 439.00	24	QSL1313/6	\$ 244.00	61
KCD33/9-10A	\$ 2,089.00	11	KSOVB1119U/5	\$ 389.00	23	QSL1515/6	\$ 284.00	60
KCD36/9-10A	\$ 2,199.00	11	KSOVB1420U/5	\$ 529.00	23	QSL1719/8	\$ 349.00	60
KCFD36B/9-10BG	\$ 2,699.00	5	KSR1UA/9	\$ 659.00	20	QSL2020/10	\$ 559.00	59
KCFS30B/10-10BG	\$ 1,749.00	5	KSS3UA/7D	\$ 379.00	20	QSL2020/7	\$ 254.00	45
KCFS33B/10-10BG	\$ 1,949.00	5	KSS4UA/9D	\$ 619.00	19	QSL2020/8	\$ 329.00	45
KCFS36B/10-10BG	\$ 2,079.00	5	KSS5UA/9D	\$ 749.00	19	QSL2225/12	\$ 889.00	59
KCS21SR/8-10BG	\$ 999.00	12	KSS6UA/9D	\$ 709.00	18	QSLA2031/8	\$ 579.00	45
KCS30/10-10A	\$ 1,329.00	11	KSS7UA/9D	\$ 759.00	19	QSLA2217/8	\$ 399.00	44
KCS33/10-10A	\$ 1,419.00	12	KSS8UA/8D	\$ 599.00	19	QSLA2225/10	\$ 759.00	58
KCUC27R/9-10BG	\$ 1,539.00	8	QCA1942/10	\$ 1,239.00	58	QSLA2225/8	\$ 519.00	45
KCUC33R/9-10BG	\$ 1,859.00	9	QCLA2027L/8	\$ 709.00	43	QSLA2233/8	\$ 589.00	46
KCUC36R/9-10BG	\$ 2,229.00	9	QCLA2027R/8	\$ 709.00	43	QSLF1717/7	\$ 559.00	38
KCUD30/9-10BG	\$ 1,799.00	8	QCLA2031L/8	\$ 739.00	43	QSLF2016/8	\$ 669.00	38
KCUD33/9-10BG	\$ 1,989.00	8	QCLA2031R/8	\$ 739.00	43	QSLF2020/10	\$ 909.00	58
KCUD36/9-10BG	\$ 2,089.00	8	QCLF2027R/8	\$ 839.00	37	QSLF2020/12	\$ 1,059.00	58
KCUS21A/8-10BG	\$ 839.00	7	QCLF2031R/8	\$ 849.00	37	QSLF2020/8	\$ 609.00	38
KCUS22A/8-10BG	\$ 679.00	9	QCLF2039DBR/8	\$ 1,099.00	37	QSLF2225/8	\$ 679.00	37
KCUS24A/9-10BG	\$ 1,219.00	7	QCM2033/8	\$ 699.00	43	QSLY2020/8	\$ 689.00	35
KCUS30A/9-10BG	\$ 1,269.00	7	QCM1826/7	\$ 509.00	43	QSLY2225/8	\$ 779.00	35
KCUS33A/9-10BG	\$ 1,359.00	7	QCMU2029R/8	\$ 709.00	52	QSR18/8	\$ 599.00	60
KCUS8A/8-10BG	\$ 559.00	9	QCR/8	\$ 1,169.00	46	QSU1113/6	\$ 224.00	56
KGD1U/8	\$ 799.00	29	QCUA1827L/8	\$ 649.00	52	QSU1315/6	\$ 274.00	56
KGD2U/9	\$ 979.00	29	QCUA1827R/8	\$ 649.00	52	QSU1614/6	\$ 299.00	55
KGDC2027R/8	\$ 749.00	28	QCUA1831L/8	\$ 719.00	51	QSU1812/7	\$ 274.00	56
KGDC2031R/8	\$ 799.00	28	QCUA1831R/8	\$ 719.00	51	QSU1820/10	\$ 549.00	54
KGDC2RU/8	\$ 809.00	30	QCUA1933R/8	\$ 779.00	51	QSUA1616/6	\$ 309.00	55
KGDCR1U/8	\$ 889.00	30	QD1831/8	\$ 499.00	42	QSUA1816/8	\$ 299.00	55
KGDL2031/8	\$ 749.00	28	QDCU2031R/8	\$ 759.00	52	QSUA1820/8	\$ 309.00	54
KGDL2233/9	\$ 919.00	29	QDFS31B	\$ 1,209.00	36	QSUA1831/8	\$ 499.00	53
KGS1U/8	\$ 859.00	30	QDFU1831/8	\$ 639.00	40	QSUA1914/7	\$ 359.00	55
KGS2U/8	\$ 769.00	30	QDL2031/7	\$ 439.00	42	QSUA1917/8	\$ 409.00	54
KGS3U/8	\$ 659.00	31	QDL2031/8	\$ 529.00	42	QSUA1922/8	\$ 459.00	53
KGSL2017/8	\$ 639.00	29	QDLA2233/8	\$ 719.00	42	QSUA1925/8	\$ 489.00	53
KGSL2023/8	\$ 729.00	29	QDLF2031/8	\$ 829.00	36	QSUA1933/8	\$ 539.00	53
KGSL2031/8	\$ 809.00	28	QDLF2233/8	\$ 1,059.00	36	QSXU2123/8	\$ 429.00	54
KSC1RUA/9D	\$ 1,179.00	18	QDLY2031	\$ 939.00	36	QTCM1841/8	\$ 1,249.00	46
KSC2RUA/9D	\$ 919.00	18	QDUA1831/8	\$ 529.00	51	QTU1842/8	\$ 1,039.00	52
KSCM1RUA/9D	\$ 1,419.00	19	QDUA1933/8	\$ 599.00	51			
KSCM3RUA/9D	\$ 989.00	19	QS1113/6	\$ 244.00	61			
KSD1UA/9D	\$ 1,049.00	17	QS1315/6	\$ 274.00	60			
KSD2UA/9D	\$ 919.00	17	QS1614/6	\$ 309.00	61			
KSDCRU/9	\$ 1,059.00	17	QS1820/10	\$ 539.00	59			
KSOV1318U/7	\$ 429.00	23	QSA1616/6	\$ 329.00	61			

QUICK FIND GUIDE

FAUCETS & FITTINGS

Model	Price	Page
KF10A.....	\$ 509.00	64
KF10B.....	\$ 709.00	64
KF10C.....	\$ 569.00	64
KFPD1100.....	\$ 569.00	65
KFPD1150.....	\$ 719.00	65
KFPD1200.....	\$ 659.00	65
KFPD1700.....	\$ 659.00	65
KFPD1800.....	\$ 659.00	65
KFPD1900.....	\$ 659.00	65
KFPD2000.....	\$ 659.00	65
KFPD2100.....	\$ 359.00	65
KFPD3100.....	\$ 359.00	65
KFPOS100.....	\$ 469.00	65
KFPOS150.....	\$ 619.00	65
KSD100.....	\$ 124.00	67
KSD10A.....	\$ 134.00	67
KSD10C.....	\$ 184.00	67
KSD1100.....	\$ 144.00	67
KSD1150.....	\$ 184.00	67
KSD1200.....	\$ 164.00	67
KSD150.....	\$ 164.00	67
KSD1700.....	\$ 164.00	67
KSD1800.....	\$ 164.00	67
KSD1900.....	\$ 164.00	67
KSD2000.....	\$ 164.00	67
PF10A.....	\$ 619.00	64

WASTE DISPOSERS

Model	Price	Page
AS200.....	\$ 164.00	69
KWD125B1/EZ.....	\$ 619.00	69
KWD125C1/EZ.....	\$ 459.00	69
KWD33C1/EZ.....	\$ 164.00	68
KWD50C1/EZ.....	\$ 229.00	68
KWD50C2/EZ.....	\$ 184.00	68
KWD75B1/EZ.....	\$ 489.00	69
KWD75C1/EZ.....	\$ 349.00	68

ACCESSORIES

Model	Price	Page	Model	Price	Page
31548.....	\$ 4.30	76	BGDS30S.....	\$ 369.00	73
61621.....	\$ 30.00	75	BGDS33S.....	\$ 339.00	73
61622.....	\$ 329.00	75	BGZ10S.....	\$ 142.00	74
100.....	\$ 19.00	75	BGZ14S.....	\$ 148.00	75
1047.....	\$ 26.00	75	BGZ1512S.....	\$ 142.00	75
1130B.....	\$ 10.00	75	BGZ15S.....	\$ 154.00	74
1135.....	\$ 25.00	75	BGZ18S.....	\$ 164.00	75
1135-CS.....	\$ 25.00	75	BGZ23S.....	\$ 169.00	75
1135/60.....	\$ 1,349.00	75	C09S.....	\$ 164.00	72
1135B.....	\$ 10.00	75	C20S.....	\$ 112.00	72
1135B-CS.....	\$ 9.60	75	C30S.....	\$ 125.00	72
1135T.....	\$ 8.50	75	C50S.....	\$ 154.00	72
1140.....	\$ 26.00	75	CA1W.....	\$ 55.00	72
1140/60.....	\$ 1,376.00	75	CM100.....	\$ 59.00	72
125GOWK.....	\$ 62.00	75	DBR10S.....	\$ 140.00	72
20102.....	\$ 8.50	75	DR1614.....	\$ 80.00	72
315-9.....	\$ 8.50	75	EL-CLIPS.....	\$ 6.40	76
31703.....	\$ 2.20	76	GB1712M.....	\$ 164.00	72
61411.....	\$ 14.50	75	GB50.....	\$ 254.00	72
BG10S.....	\$ 127.00	73	MB100.....	\$ 214.00	72
BG110S.....	\$ 164.00	74	MB1610.....	\$ 89.00	72
BG11S.....	\$ 122.00	73	MB1612.....	\$ 99.00	72
BG13S.....	\$ 115.00	73	MB1710.....	\$ 110.00	72
BG14S.....	\$ 127.00	73	MB1809.....	\$ 96.00	72
BG160S.....	\$ 154.00	74	MB20.....	\$ 144.00	72
BG170S.....	\$ 142.00	74	MB50.....	\$ 110.00	72
BG180S.....	\$ 148.00	74	MB55.....	\$ 110.00	72
BG190S.....	\$ 214.00	74	MBZ16.....	\$ 161.00	72
BG200S.....	\$ 229.00	74	MBZ17.....	\$ 161.00	72
BG20S.....	\$ 132.00	73	RM50S.....	\$ 174.00	73
BG210S.....	\$ 294.00	74	RM55S.....	\$ 174.00	72
BG220S.....	\$ 174.00	74	SPKHA1.....	\$ 46.00	68
BG240S.....	\$ 309.00	74	SPKHA100.....	\$ 22.00	68
BG30S.....	\$ 164.00	74	SPKHA110.....	\$ 72.00	68
BG35S.....	\$ 132.00	74	SPKHA120.....	\$ 62.00	68
BG65S.....	\$ 142.00	74	SPKHA121.....	\$ 62.00	68
BG90S.....	\$ 164.00	74	SPKHA130.....	\$ 154.00	68
BGA1217S.....	\$ 96.00	74	SPKHA131.....	\$ 154.00	68
BGA1517S.....	\$ 127.00	74	SPKHA132.....	\$ 132.00	68
BGA1817S.....	\$ 142.00	74	SPKHA135.....	\$ 132.00	68
BGA1820S.....	\$ 164.00	74	SPKHA136.....	\$ 132.00	68
BGA2317S.....	\$ 164.00	74	SPKHA137.....	\$ 132.00	68
BGA3117S.....	\$ 194.00	74	SPKHA138.....	\$ 132.00	68
BGDS0817S.....	\$ 151.00	73	SPKHA2.....	\$ 72.00	68
BGDS10S.....	\$ 159.00	73	SPKHA20.....	\$ 83.00	68
BGDS11S.....	\$ 174.00	73	SPKHA21.....	\$ 117.00	68
BGDS13S.....	\$ 194.00	73	SPKHA3.....	\$ 31.00	68
BGDS14S.....	\$ 209.00	73	SPKHA4.....	\$ 37.00	68
BGDS15S.....	\$ 209.00	73	SPKHA40.....	\$ 18.00	68
BGDS16S.....	\$ 224.00	73	SPKHA41.....	\$ 23.00	68
BGDS18S.....	\$ 244.00	73	SPKHA5.....	\$ 4.30	68
BGDS21S.....	\$ 284.00	73	SPKHA6.....	\$ 4.30	68
BGDS22S.....	\$ 174.00	73	SPKHA60.....	\$ 3.10	68
BGDS27S.....	\$ 339.00	73	SPKHA7.....	\$ 9.60	68
			SPKHA8.....	\$ 3.20	68



KINDRED ... MAKING YOUR BUSY LIFE SIMPLER.

Thanks for perusing our product pages. We look forward to being an integral part of your new home, renovation or building project. When you want to know more about our products ... or find the dealer nearest you ... please contact us, or visit our website ... we want to hear from you.



www.kindredcanada.com

Franke Kindred Canada

Customer Service Department
P.O. Box 190, 1000 Franke Kindred Road
Midland, Ontario Canada L4R 4K9

Telephone: 1-866-687-7465
Fax: 1-800-361-8408
Email: info@kindred-sinkware.com
www.kindredcanada.com

Monday to Thursday - 8:00 am to 5:00 pm
Friday - 8:00 am to 3:30 pm
(Eastern Standard Time)