

540-00111-01

REV	DATE
01	2015/07/10

Zeversolar Service Line

China (incl. Hongkong, Macau)

Jiangsu Zeversolar New Energy Co., Ltd.

Tel.: +86 512 6937 0998-8866

E-mail: service.china@zeversolar.com

Add.: Building 9, No.198 Xiangyang Road, Suzhou 215011, China

Australia

Zeversolar Australia

Tel.: +61(0)1300101883

E-mail: service.apac@zeversolar.com

Add.: Suite 2.23 Level 2, 838 Collins Street, Melbourne, Docklands Vic 3008, Australia

Europe Region

Zeversolar GmbH

Tel.: +49(0) 2102 420 944

E-mail: service.eu@zeversolar.net

Add.: Luxemburger Straße 59, 50674 Köln, Germany

United Kingdom:

Tel.: +44 (0) 800 731 0899

E-mail: service.eu@zeversolar.net

Rest of the world

E-mail: service.row@zeversolar.com



Installation and Operating Instructions

Eversol-TLC 10K/TLC 15K/TLC 17K/TLC 20K Solar Inverters

Table of Contents

1 About this manual.....	4
1.1 Validity	4
1.2 Target group.....	4
1.3 Symbols used in this manual	5
2 Safety	6
2.1 Intended use.....	6
2.2 Safety standards.....	6
2.3 Important safety information.....	7
2.4 Symbols on the type label.....	8
2.5 Basic safety protection	9
3 Unpacking	10
3.1 Scope of delivery.....	10
3.2 Check for transport damage.....	10
4 Mounting.....	11
4.1 Ambient conditions.....	11
4.2 Selecting the mounting location	13
4.3 Mounting the inverter with the wall bracket	14
5 Electrical connection	17
5.1 Safety.....	17
5.2 System layout of units without integrated DC-switch.....	18
5.3 Overview of the connection area.....	19
5.4 AC connection	20
5.4.1 Conditions for the AC connection	20
5.4.2 Grid connection	22
5.4.3 Second protective earthing connection	24
5.4.4 Residual current protection	25

5.4.5	Overvoltage category	25
5.4.6	Miniature circuit breaker	26
5.5	DC connection	26
5.5.1	Connection of the PV generator (DC)	27
5.5.2	Assembling the DC connectors.....	28
5.5.3	Disassembling the DC connectors	30
5.5.4	Connecting the PV array.....	31
6	Communication	33
6.1	Monitoring of system via RS485.....	33
6.2	Updating the firmware via USB	36
7	Commissioning	37
7.1	Electrical checks.....	37
7.2	Mechanical checks	38
7.3	Start-up	38
8	Disconnecting the inverter from voltage sources	39
9	Operating	40
9.1	Overview of the control panel.....	40
9.2	LED indicators	41
9.3	Display messages.....	42
9.4	Display	44
9.4.1	Overview of menu structure.....	44
9.4.2	Initial page	45
9.4.3	Home page	45
9.4.4	Operation information	46
9.4.5	Main menu	47
9.4.6	Statistics.....	47
9.4.7	Event log.....	48
9.4.8	Date&Time setting	48
9.4.9	Language setting	49
9.4.10	Contrast setting.....	49

9.4.11 Safety setting	50
9.4.12 Active power control	51
9.4.13 Reactive power control	51
9.4.14 PV Mode Setting	52
9.4.15 EEG Setting	52
9.4.16 Communication Setting	53
9.4.17 Device information	53
9.4.18 Clear the history data	54
10 Technical data	55
10.1 DC input data	55
10.2 AC output data	57
10.3 Safety regulations	58
10.4 General data	59
10.5 Efficiency	60
10.5.1 Efficiency curve TLC 10K	60
10.5.2 Efficiency curve TLC 15K	61
10.5.3 Efficiency curve TLC 17K	62
10.5.4 Efficiency curve TLC 20K	63
10.6 Power reduction	64
11 Troubleshooting	66
12 Maintenance	68
12.1 Cleaning the contacts of the DC-switch	68
12.2 Cleaning the heat sink	68
12.3 Cleaning the fans	68
13 Recycling and disposal	69
14 Contact	69

1 About this manual

General Notes

Eversol is a transformerless solar inverter with two MPP trackers. It converts the direct current (DC) from a photo-voltaic (PV) generator to grid-compliant alternating current (AC) and feeds it into the grid.

1.1 Validity

This manual describes the mounting, installation, commissioning and maintenance of the following Zegersolar inverters: Eversol-TLC 10K/15K/17K/20K.

Observe all documentation that accompanies the inverter. Keep them in a convenient place and available at all times.

1.2 Target group

This manual is for qualified electricians only who must perform the tasks exactly as described.

All persons installing inverters must be trained and experienced in general safety which must be observed when working on electrical equipment. Installation personnel should also be familiar with local requirements, rules and regulations.

1.3 Symbols used in this manual

The safety precautions and general information are used in this manual as follows:



DANGER!

DANGER indicates a hazardous situation which, if not avoided, will result in death or serious injury.



WARNING!

WARNING indicates a hazardous situation which, if not avoided, could result in death or serious injury.



CAUTION!

CAUTION indicates a hazardous situation which, if not avoided, could result in minor or moderate injury.



NOTICE!

NOTICE indicates a situation which, if not avoided, could result in property damage.



INFORMATION

INFORMATION provides tips which are valuable for the optimal installation and operation of the inverter.

2 Safety

2.1 Intended use

2.1.1. Eversol converts the direct current from a PV generator into grid-compliant alternating current.

2.1.2. Eversol is suitable for indoor and outdoor use.

2.1.3. Eversol must only be operated with PV arrays (PV modules and cabling) of protection class II, in accordance with IEC 61730, application class A.

Do not connect any sources of energy other than PV modules to the Eversol.

2.1.4. PV modules with a high capacitance to earth may only be used if their coupling capacity does not exceed 1.0 μ F.

2.1.5. When the PV modules are exposed to light, a DC voltage is supplied to this equipment.

2.1.6. When designing the PV installation, ensure that the values comply with the permitted operating range of all components at all times. The free design program "Zeverplan" (<http://www.zeverplan.com>) will assist you.

2.2 Safety standards

Eversol complies with the EU Low Voltage Directive 2006/95/EC and the EMC Directive 2004/108/EC. Eversol also complies with the requirement for safety and EMC in Australia and New Zealand market.

For more information about certificates in other countries and regions, please visit website www.zeversolar.com.

2.3 Important safety information



DANGER!

Danger to life due to high voltage in the inverter!

- All work on the inverter may only be carried out by qualified personnel who have read and fully understood all safety information contained in this manual.
- Children should be supervised to ensure that they do not play with this device.



WARNING!

Risk of injury due to electric shock and fire caused by high leakage current!

- The inverter must be reliably grounded in order to protect property and personal safety.



CAUTION!

Risk of injury due to hot heat sink!

- The heat sink may become hot during operation. Do not touch!



CAUTION!

Possible damage to health due to the effects of electromagnetic radiation!

- Please maintain a distance of at least 20cm from the inverter when it is in operation.











NOTICE!

Grounding the PV generator!

- Comply with local regulations for grounding the PV generator. We suggest that the frames of PV modules be reliably grounded.
- Do not ground any of the terminals of the strings.

2.4 Symbols on the type label

Symbol	Explanation
	Beware of high voltage and operating current. The inverter operates at high voltage and current. Work on the inverter may only be carried out by skilled and authorized electricians.
	Beware of hot surfaces. The inverter can become hot during operation. Avoid contact with it during operation.
	Do not dispose of this inverter with household waste. For more information on disposal, please see chapter 13 "Recycling and disposal".
	CE mark. The inverter complies with the requirements of the applicable EC guidelines.
	Certified safety The product is TUV-tested and complies with the requirements of the German Equipment and Product Safety Act.
	RCM The product complies with the requirements of the applicable Australian low voltage and electromagnetic compatibility standards.
	Capacitor discharge Before opening the covers, the inverter must be disconnected from the grid and PV array. Wait at least five minutes to allow the energy storage capacitors to fully discharge.
	Refer to the manual accompanying the inverter.
	Risk of danger, warning and caution Safety information important for human safety. Failure to observe the safety information in this manual may result in injury or death.

2.5 Basic safety protection

We provide the following safety protection:

- 1 Over voltage, under voltage protection.
- 2 Over frequency, under frequency protection.
- 3 Over temperature monitoring.
- 4 Residual current monitoring.
- 5 Isolation fault detection.
- 6 Anti-islanding protection.
- 7 DC feed-in monitoring.

3 Unpacking

3.1 Scope of delivery

Object	Description	Quantity
A	Inverter	1
B	Wall bracket	1
C	Mounting accessory kit	1
D	Earthing parts	1
E	RJ45 plug	2
F	Cord end terminal *	5
G	AC connection plug	1
H	Documentation	1
I	Positive DC connector	4
J	Negative DC connector	4

*) Only suitable for stranded copper wire AWG 10.



A



B



C



D

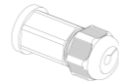

E



F



G



H

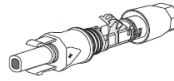

I

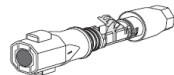

J

Please carefully check all of the components in the carton. If anything is missing, contact your dealer at once.

3.2 Check for transport damage

Thoroughly inspect the packaging upon delivery. If you detect any damage to the packaging which indicates the inverter may have been damaged, inform the responsible shipping company immediately. We will be glad to assist you if required.

4 Mounting

4.1 Ambient conditions

- 1 Be sure the inverter is installed out of the reach of children.
- 2 Mount the inverter in areas where it cannot be touched inadvertently.
- 3 Ensure good access to the inverter for installation and possible service.
- 4 Observe the minimum clearances to walls, other inverters, or objects as follows to ensure that heat can escape.

Direction	Min. clearance (mm)
above	200
below	500
sides	300

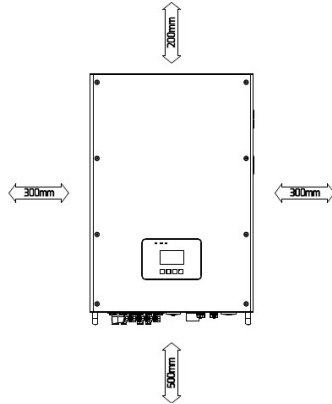

Clearances for one inverter

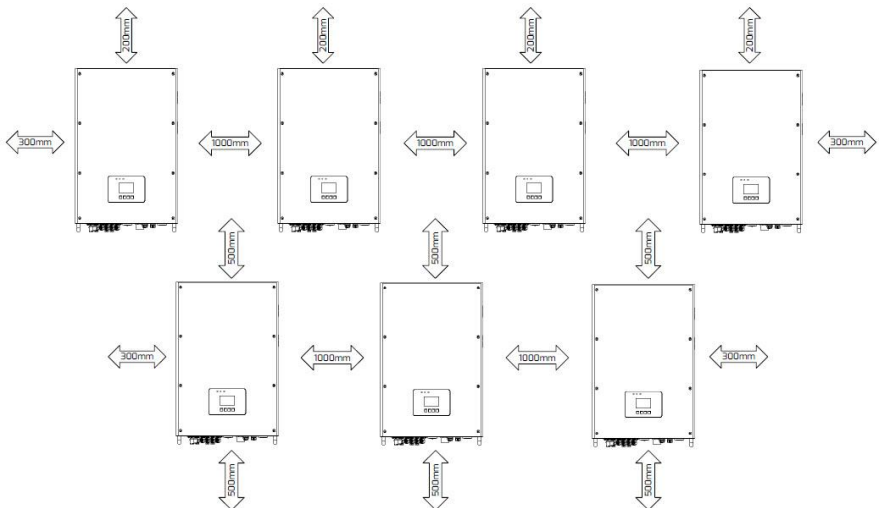

Clearances for multiple inverters

- 5 The ambient temperature should be below 40°C to ensure optimal operation.

- 6 Avoid exposing the inverter to direct sunlight, rain and snow to ensure optimal operation and extend service life.

Recommend to mount an awning above the inverter or mount the inverter under the shaded site of the building.

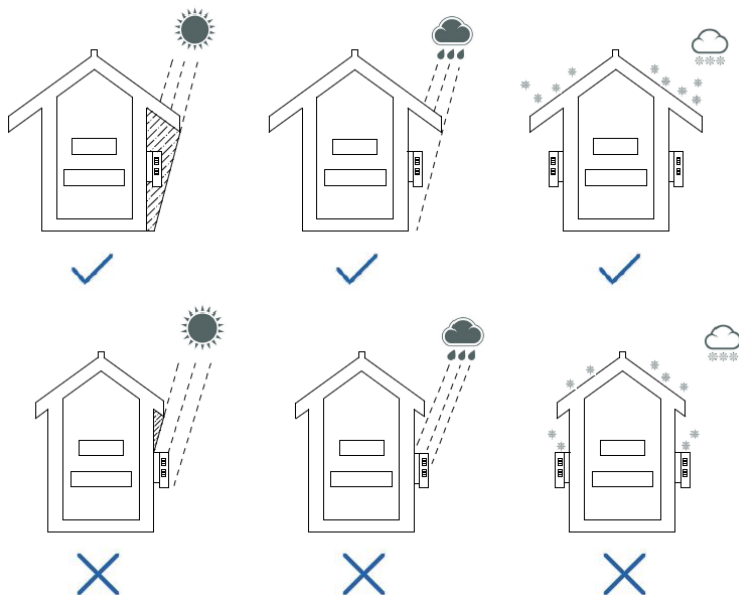

- 7 The mounting method, location and surface must be suitable for the inverter's weight and dimensions.
- 8 If mounted in a residential area, we recommend mounting the inverter on a solid surface. Plasterboard and similar materials are not recommended due to audible vibrations when in use.
- 9 Don't put any objects on the inverter. Do not cover the inverter.

4.2 Selecting the mounting location



Danger!

Danger to life due to fire or explosion!

- Do not mount the inverter on flammable construction materials.
- Do not mount the inverter in areas where flammable materials are stored.
- Do not mount the inverter in areas where there is a risk of explosion.

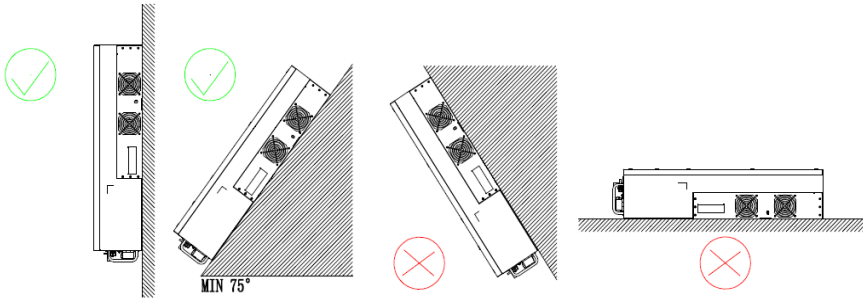

- 1 Mount the inverter vertically or tilted backward by a maximum of 15°.
- 2 Never mount the inverter tilted forward or sideways.
- 3 Never mount the inverter horizontally.
- 4 Mount the inverter at eye level to make it easy to operate and to read the display.
- 5 The electrical connection area must point downwards.

4.3 Mounting the inverter with the wall bracket



CAUTION!

Risk of injury due to the heavy weight of the inverter!

- When mounting, two persons are needed, take into account that the inverter weighs approx. 48kg.

Mounting procedures:

- 1 Use the wall bracket as a drilling template and mark the positions of the drill holes, Drill 5 holes required using a drill with 10mm bit. The holes must be about 70mm deep. keep the drill vertical to the wall, and hold the drill steady to avoid tilted holes.

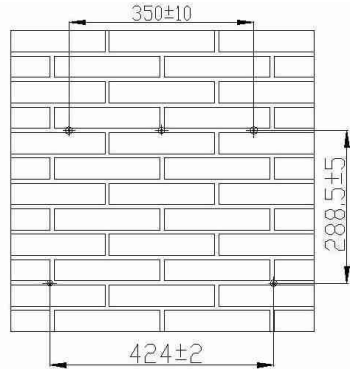

WARNING!

Risk of the inverter falling off and injuring the installer!

- Before inserting wall anchors, measure the depth and distance of the holes.
- If the measured values don't fulfill the mounting requirement, redrill the holes.

- 2 Fix the wall bracket to the wall with 5 wall anchors and bolts delivered with the inverter.

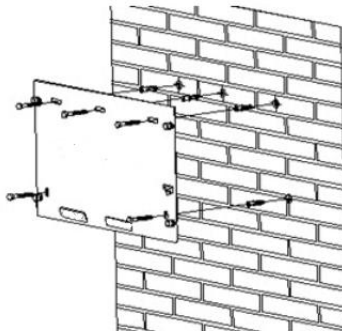

- 3 Holding the inverter using the handles, attach the inverter onto the wall bracket tilted slightly downwards.

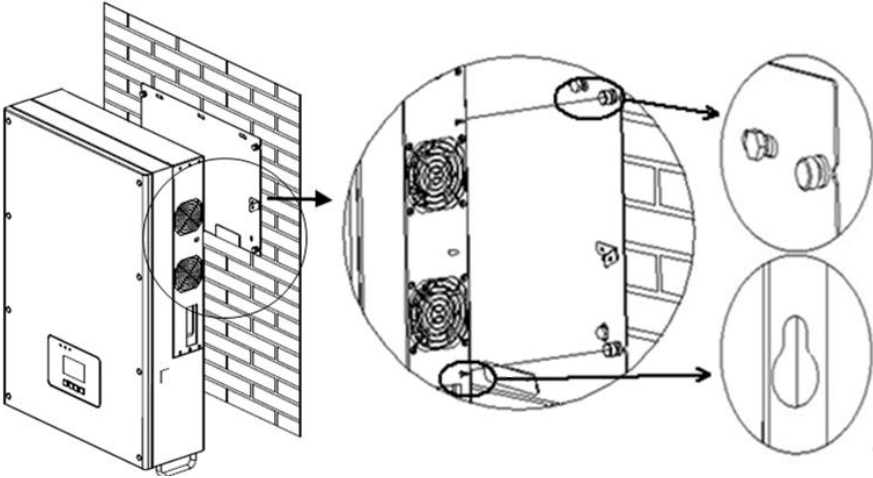

- 4 Check both sides of the inverter to ensure that it is securely in place.

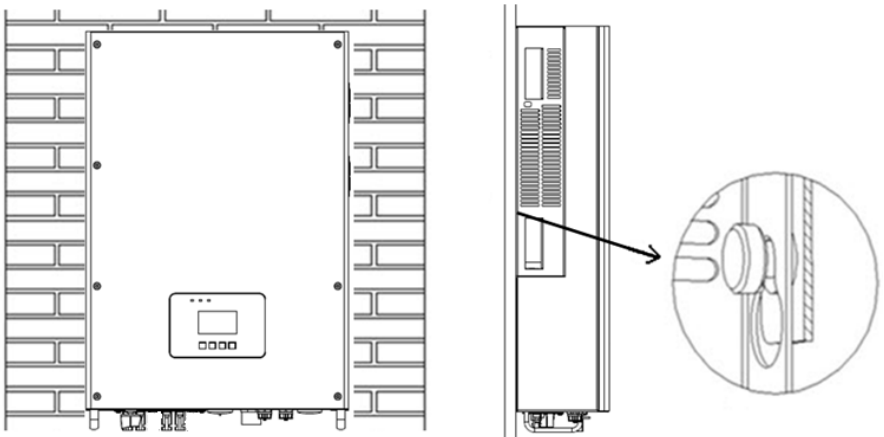

- 5 Push the inverter inwards to the limit stop and attach it to both sides of the wall bracket using the M5 screws and washers.

To prevent possible theft, an extra safeguard is provided. The inverter can be locked to the left side of bracket as follows.

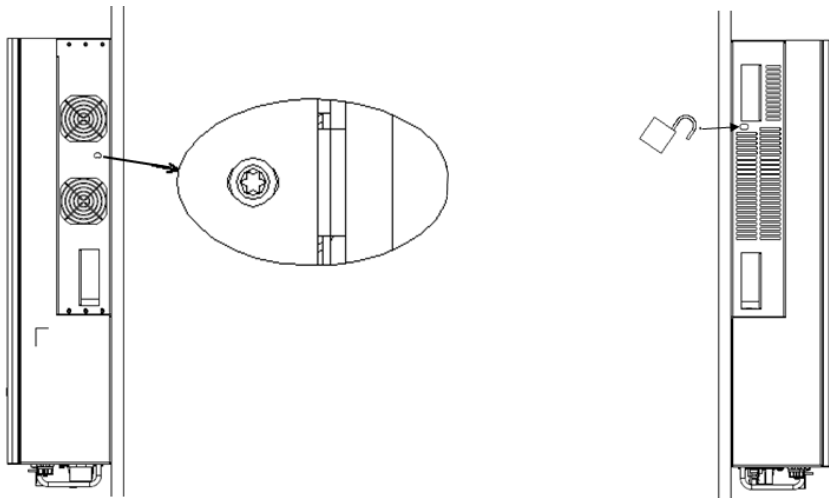

INFORMATION

If the inverter is installed outdoors, please refer to the information below.

- Please use a padlock for outdoor installation, check the reliability of the padlock regularly.
- Store the key carefully for possible service.

5 Electrical connection

5.1 Safety



WARNING!

Risk of injury due to electric shock!

- The inverter must be installed only by trained and authorized electricians.
- All electrical installations must be done in accordance with the National Wiring Rules standards and local code.



CAUTION!

Risk of injury due to electric shock!

- The external protective earthing conductor is connected to the inverter's protective earthing terminal through an AC connector, make sure the connection is reliable.
- When connecting, connect the AC connector first to ensure the inverter earthing and then connect the DC inputs.
- When disconnecting, disconnect the DC inputs first and then disconnect the AC connector.
- Do not, under any circumstances, connect the DC inputs when the AC connector is unplugged.

5.2 System layout of units without integrated DC-switch

Local standards or codes may require that PV systems are fitted with an external DC-switch on the DC side. The DC-switch must be able to safely disconnect the open-circuit voltage of the PV array plus a safety reserve of 20%.

Install a DC-switch to each PV string to isolate the DC side of the inverter.

We recommend the following electrical connection:

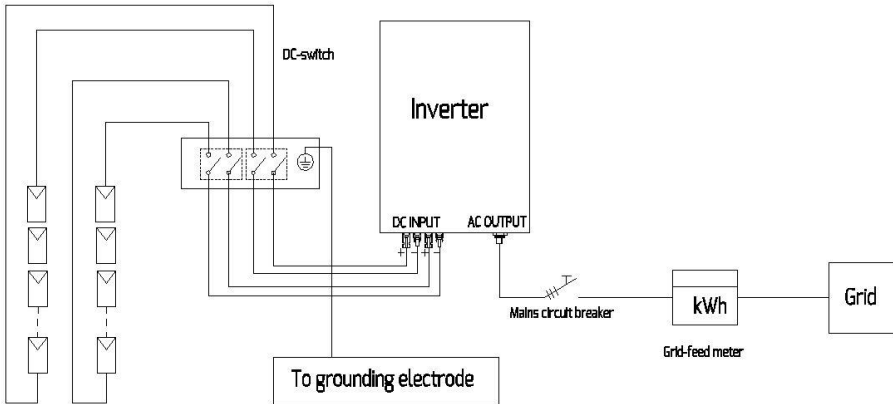

5.3 Overview of the connection area

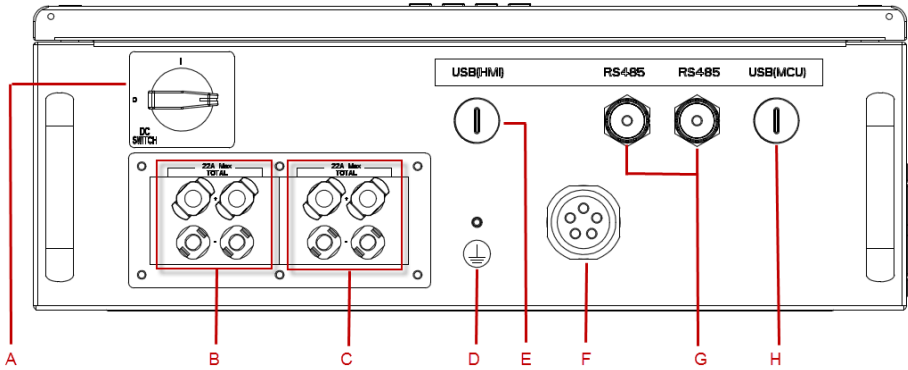

Object	Description
A	DC-switch (optional): switch on or off for PV-load
B	DC input A: plug-in connectors to connect the PV array A
C	DC input B: plug-in connectors to connect the PV array B
D	Earthing terminal: connect a second protective earthing conductor
E	USB (HMI) interface: update or burn the HMI firmware
F	AC output: plug-in connector to connect the grid.
G	RJ45 interface: connect the monitoring device
H	USB (MCU) interface: update or burn the MCU firmware

5.4 AC connection



DANGER!

Danger to life due to high voltages in the inverter!

- Before making the electrical connection, ensure that the miniature circuit-breaker is switched off and cannot be reactivated.

5.4.1 Conditions for the AC connection

Cable Requirements

The grid connection is made using 5 conductors (L1, L2, L3, N, and PE). We recommend the following requirements for stranded copper wire.

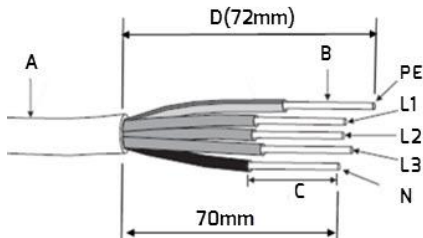

Object	Description	Value
A	External diameter	13 ... 17.5 mm
B	Conductor cross-section area	6.0 ... 10.0 mm ²
C	Stripping length of the insulated wires	Approx. 9 mm
D	Stripping length of the AC cable's outer sheath	Approx. 72 mm

The PE insulated conductor must be 2 mm longer than the L and N conductors

Larger cross-sections should be used for longer leads.

Cable design

The conductor cross-section should be dimensioned to avoid power loss in cables exceeding 1% of rated output power.

The maximum cable lengths relative to the conductor cross-section as follows:

conductor cross-section	Maximum cable length			
	TLC 10K	TLC 15K	TLC 17K	TLC 20K
6 mm ²	48 m	32 m	28 m	24 m
10 mm ²	70 m	53 m	47 m	40 m

The required conductor cross-section depends on the inverter rating, ambient temperature, routing method, cable type, cable losses, valid installation requirements of the country of installation, etc.

5.4.2 Grid connection

Overview of the AC Connection Plug

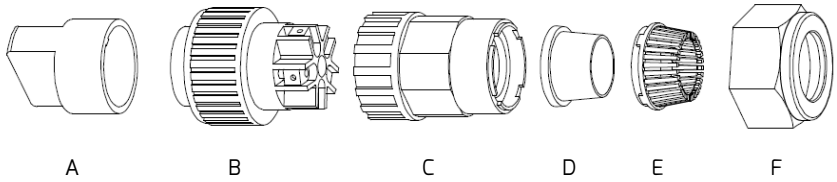

	Object	Description	
Accessory	A	Plastic fixture (auxiliary installation)	
AC Connection Plug	B	Socket element	
	C	Adapter	
	D *	Seal ring	Thicker seal ring is suitable for cable diameter 12-18 mm
			Thinner seal ring is suitable for cable diameter 16-21mm
	E	Fastening case	
	F	Swivel nut	

* There are two seal rings in the AC connection plug kit, please choose one according to different cable external diameter.

Procedure

- 1 Switch off the miniature circuit breaker and secure it against being inadvertently switched back on.
- 2 Guide the swivel nut, the fastening case with sealing ring and the adapter over the AC cable.

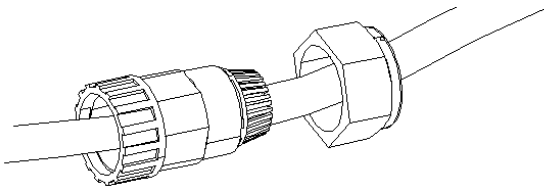

- 3 Strip the cable jacket (72mm) and the insulation (8.5mm), cable size 10mm² Max. Insert bared conductors into the cord end terminal and crimp the contact. The cord end terminals provided are only suitable for stranded copper wire AWG 10.

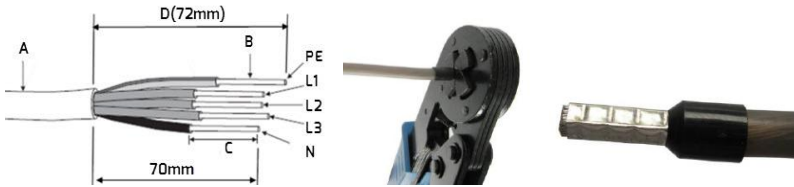

- 4 Insert the stripped conductors L1, L2, L3, N and PE into the corresponding terminals and tighten the screw with torque 2.0-2.5Nm using an Allen key (AF 3.0) . The ground wire must be locked in the “PE” position.

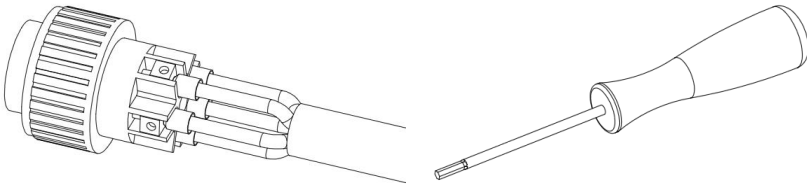

CAUTION!

The inverter can be destroyed due to the wrong wiring!

Please ensure that the polarity of the conductors matches the signs of the screw terminals on the socket element.

- 5 Assemble the socket element, adapter and cable nut as shown below with a torque of 3-4Nm.

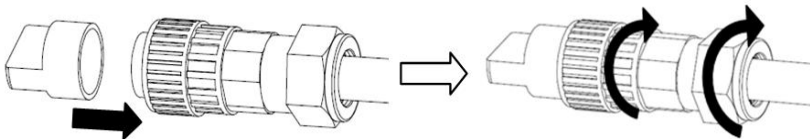

- 6 Insert the plug into the receptacle with the key aimed at the corresponding slot. Finally rotate the coupling nut clockwise until you hear a click.

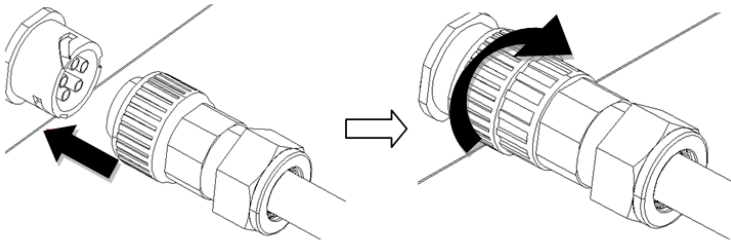

5.4.3 Second protective earthing connection

If required, the earthing terminal can be used to connect a second protective conductor or as equipotential bonding.

Remove the earthing parts from the accessory bag, connect the earthing conductor to the earthing terminal located at the bottom-middle of the inverter, and tighten it firmly.

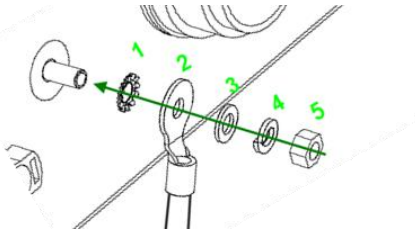

Earthing parts information:

Object	Description	Quantity
1	Serrated lock washer	1
2	Terminal lug (M5) with protective conductor	1
3	Washer diameter 5mm	1
4	Lock washer M5	1
5	Nut M5	1

5.4.4 Residual current protection

The inverter is equipped with an all-pole sensitive residual current monitoring unit (RCMU) with an integrated differential current sensor which fulfills the requirement of DIN VDE 0100-712 (IEC60364-7-712:2002).

Therefore, an external residual current device (RCD) is not required. If an external RCD needs to be installed because of local regulations, a RCD type A or type B can be installed as an additional safety measure.

The all-pole sensitive residual current monitoring unit (RCMU) detects alternating and direct differential currents. The integrated differential current sensor detects the current difference between the neutral conductor and the line conductor. If the current difference increases suddenly, the inverter disconnects from the grid. The function of the all-pole sensitive residual current monitoring unit (RCMU) has been tested according to IEC 62109-2.



INFORMATION

If an external residual current device (RCD) needs to be used, please refer to the information below.

Where an external residual current device (RCD) is required in a TT or TN-S system, install a residual current device which trips at a residual current of 120 mA or higher. For each connected inverter, a rated residual current of 120 mA has to be provided. The rated residual current of the RCD must be equal to at least the sum of the rated residual currents of the connected inverters. That means that, if, for example, 2 transformerless inverters are connected, the rated residual current of the RCD must be at least 240 mA.

5.4.5 Overvoltage category

The inverter can be deployed in grids of installation category III or lower, as defined under IEC 60664-1. This means that it can be permanently connected at the grid-connection point in a building. In installations involving long outdoor cable routing, additional overvoltage-reducing measures must be taken so that the overvoltage category is reduced from IV to III.

5.4.6 Miniature circuit breaker



DANGER

Danger to life due to fire!

You must safeguard each inverter with an individual miniature circuit breaker in order that the inverter can be disconnected safely.

No consumer load should be applied between the miniature circuit breaker and the inverter. Use dedicated circuit breakers with load switch functionality for load switching. The selection of the miniature circuit breaker rating depends on the wiring design (wire cross-section area), cable type, wiring method, ambient temperature, inverter current rating, etc. Derating of the miniature circuit breaker rating may be necessary due to self-heating or if exposed to heat.

The maximum output current of the inverters can be found in the following table.

Type	TLC 10K	TLC 15K	TLC 17K	TLC 20K
Max. output current	16A	24A	25.8A	30A
Recommended fuse type gL/gG or comparable automatic circuit breaker rating	25A	40A	40A	40A

5.5 DC connection



DANGER

Danger to life due to high voltages in the inverter!

- Before connecting the PV generator, ensure that the DC-switch is switched off and that it cannot be reactivated.
- Do not disconnect the DC connectors under load.

5.5.1 Connection of the PV generator (DC)



INFORMATION

If need to use Y adaptors, please refer to the information below.

Y adaptors must not be visible or freely accessible in the immediate vicinity of the inverter.

- The DC circuit must not be interrupted by Y adaptors.
- In order to interrupt the DC electric circuit, disconnect the inverter from all voltage sources

- PV modules of the connected strings must be of:
 - the same type
 - the same number of series-connected PV modules
 - identical alignment
 - identical tilt
- The connection cables of the PV modules must be equipped with the connectors included in the scope of delivery.
- At the DC input of the inverter, the following limits must not be exceeded:

Type	Max. DC voltage *	Max. DC current	Max. short-circuit current
TLC 10K	1000V	22 A/11 A	32.4 A/16.2 A
TLC 15K	1000V	22 A/22 A	32.4 A/32.4 A
TLC 17K	1000V	22 A/22 A	32.4 A/32.4 A
TLC 20K	1000V	22 A/22 A	32.4 A/32.4 A

*) The Max. open-circuit voltage, which can occur at PV modules temperature of -10°C, must not exceed the Max. DC input voltage of the inverter.

- The positive connection cables of the PV modules must be equipped with the positive DC connectors.
- The negative connection cables of the PV modules must be equipped with the negative DC connectors.
- At an ambient temperature over 10°C, the open-circuit voltage of the PV strings must not exceed 90% of the maximum DC input voltage of the inverter. This prevents the voltage from exceeding the maximum DC input voltage of the inverter at lower ambient temperatures.

5.5.2 Assembling the DC connectors

Assemble the DC connectors as described below. Be sure to observe the correct polarity. The DC connectors are marked with the symbols "+" and "-".

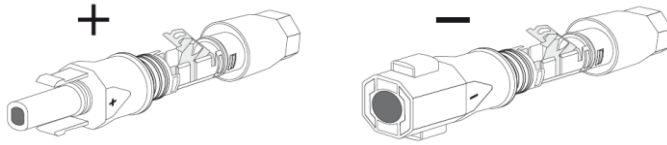

Cable requirements:

The cable must be of type PV1-F, UL-ZKLA or USE2 and comply with the following properties:

- ✧ External diameter: 5-8 mm
- ✧ Conductor cross-section: 2.5-6 mm²
- ✧ Number of conductors: at least 7
- ✧ Nominal voltage: at least 1000V

Proceed as follows to assemble each DC connector.

- 1 Strip 12 mm of the cable insulation.

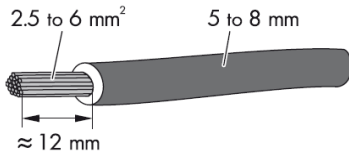

- 2 Route the stripped cable all the way into the DC connector. Ensure that the stripped cable and the DC connector have the same polarity.

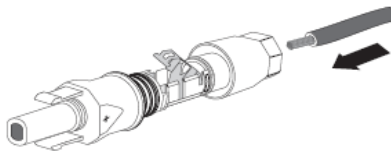

- 3 Press the clamping bracket down until it audibly snaps into place.

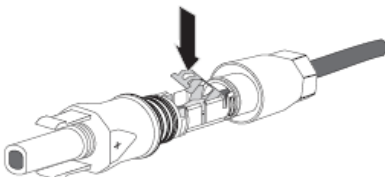

4 Ensure that the cable is correctly positioned:

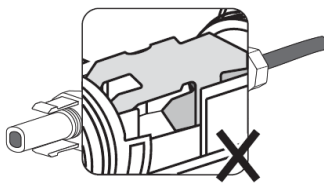
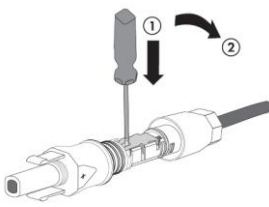
Result	Measure
<p>If the stranded wires are visible in the chamber of the clamping bracket, the cable is correctly positioned.</p> 	<ul style="list-style-type: none"> Proceed to step 5.
<p>If the stranded wires are not visible in the chamber, the cable is not correctly positioned.</p> 	<ul style="list-style-type: none"> Release the clamping bracket. To do so, insert a flat-blade screwdriver (blade width: 3.5 mm) into the clamping bracket and lever it open.  <ul style="list-style-type: none"> Remove the cable and go back to step 2.

5 Push the swivel nut up to the thread and tighten (torque: 2 Nm).

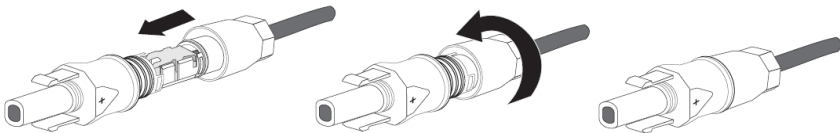

5.5.3 Disassembling the DC connectors

- 1 Unscrew the swivel nut.

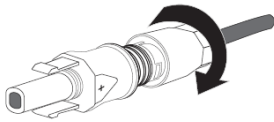

- 2 To release the DC connector, insert a flat-blade screwdriver (blade width: 3.5 mm) into the side catch mechanism and lever open.

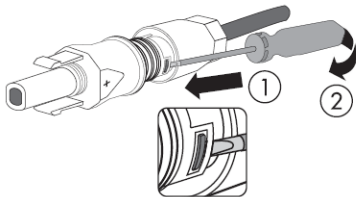

- 3 Carefully pull the DC connector apart.

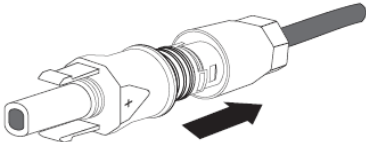

- 4 Release the clamping bracket. To do so, insert a flat-blade screwdriver (blade width: 3.5 mm) into the clamping bracket and lever it open.

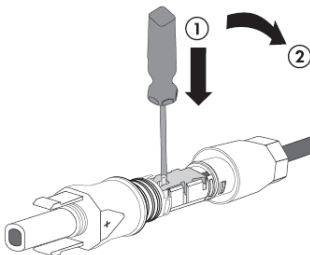

- 5 Remove the cable.

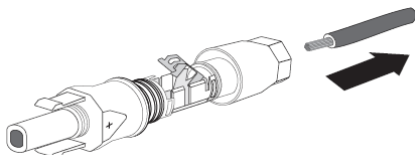

5.5.4 Connecting the PV array



NOTICE!

The inverter can be destroyed by overvoltage!

If the voltage of the strings exceeds the maximum DC input voltage of the inverter, it can be destroyed due to overvoltage. All warranty claims become void.

- Do not connect strings with an open-circuit voltage greater than the maximum DC input voltage of the inverter.
- Check the design of the PV system.

1. Ensure that the individual miniature circuit breaker is switched off and ensure that it cannot be accidentally reconnected.
2. Ensure that the DC-switch is switched off and ensure that it cannot be accidentally reconnected.
3. Ensure that there is no ground fault in the PV array.
4. Check whether the DC connector has the correct polarity.
If the DC connector is equipped with a DC cable having the wrong polarity, the DC connector must be assembled again. The DC cable must always have the same polarity as the DC connector.
5. Ensure that the open-circuit voltage of the PV array does not exceed the maximum DC input voltage to the inverter.
6. Connect the assembled DC connectors to the inverter until they audibly snap into place.
7. Ensure that all DC connectors are securely in place.

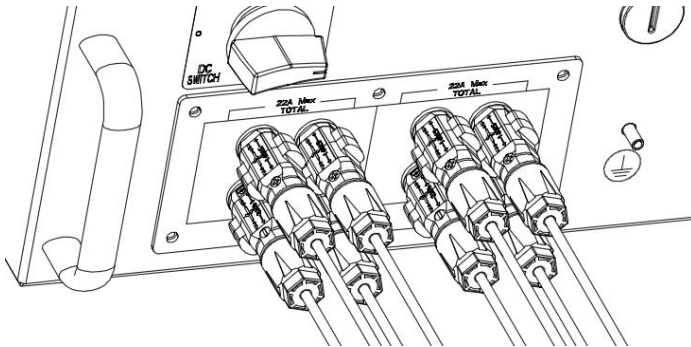



NOTICE!

Damage to the inverter due to moisture and dust penetration!

Seal the unused DC inputs with sealing plugs so that moisture and dust cannot penetrate the inverter.

- Make sure all DC connectors are securely sealed.

8. The inverter is only properly sealed when all the unused DC inputs are closed with sealing plugs.

6 Communication

6.1 Monitoring of system via RS485

This inverter is equipped with RJ45 interfaces for multipoint communication.

One PMU can monitor 30 inverters at the same time via RS485 bus. The overall length of the network cable should not exceed 1000m. The monitoring system layout for inverters is as follows.

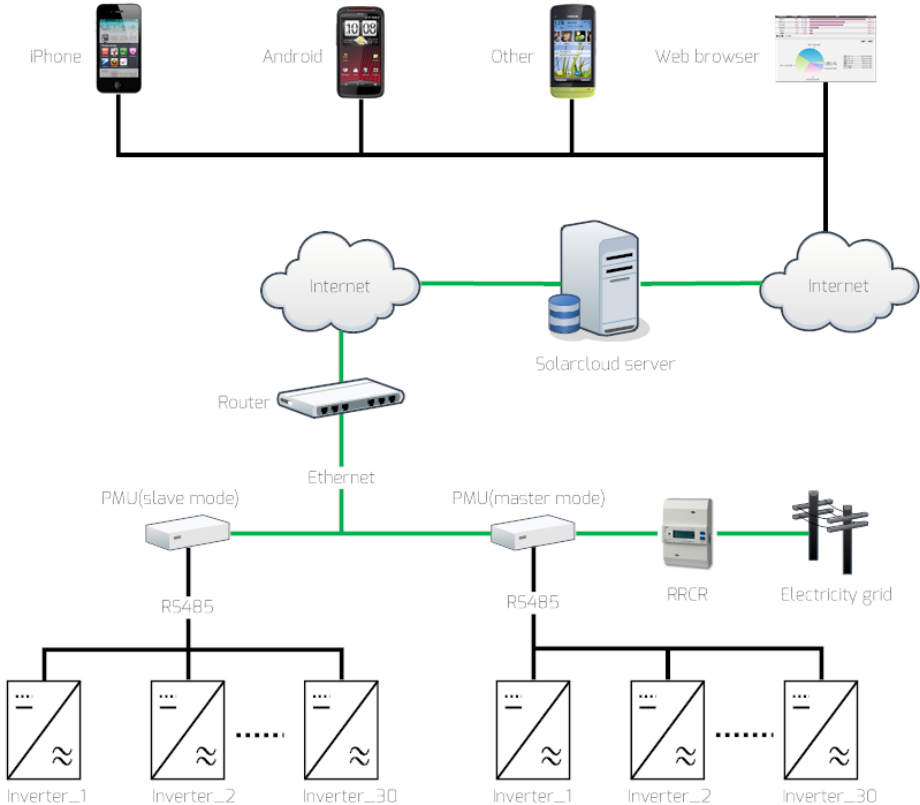

The PMU connects with the inverter via the RJ45 interface, and it connects to the router via Ethernet.

We offer a remote monitor platform “Solarcloud”. You can install the “Solarcloud” application on a smart phone using Android or iOS operating systems.

You can also visit the website (<http://solarcloud.zeversolar.com>) to browse the system information.

The pin assignment of the RJ45 socket on the inverter as follows:

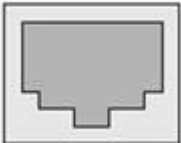
Pin1----- TX_ RS485A	 <p>PIN1-->8</p> <p>RJ45 SOCKET</p>
Pin2----- TX_ RS485B	
Pin3----- RX_ RS485A	
Pin4----- GND	
Pin5----- GND	
Pin6----- RX_ RS485B	
Pin7----- +7V	
Pin8----- +7V	

The network cable meeting the EIA/TIA 568A or 568B standard must be UV resistant if it is to be used outdoors.



NOTICE!

Damage to the inverter due to moisture and dust penetration!

If the the RJ45 plug are not installed or not installed properly, the inverter can be destroyed due to moisture and dust corrode the RJ45 socket. All warranty claims become void.

- Make sure the RJ45 plug has been tightened firmly.

Connecting the RJ45 plug:

1. Unscrew the cap nut from the RJ45 keystone socket.

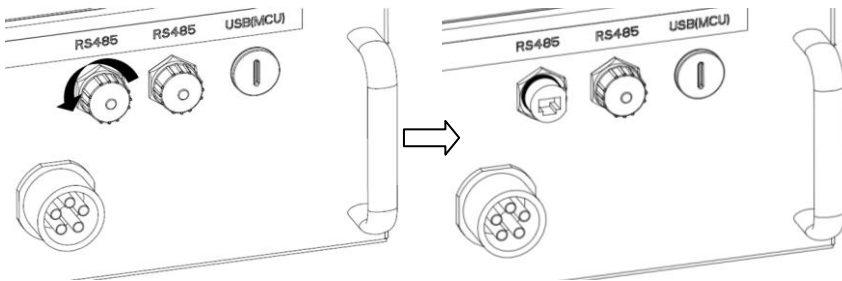

- Take out the RJ45 plug which accompanies the inverter, and disassemble it.

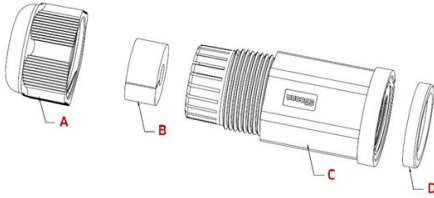

Object	Description	QTY	Color
A	Swivel nut	1	Black
B	Seal	1	Black
C	Threaded sleeve	1	Black
D	Gasket	1	Black

- Guide the network cable through the components of RJ45 plug as follows.

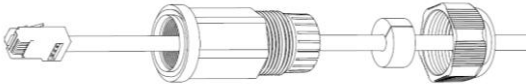

- Insert the network cable to the RJ45 keystone socket then screw the threaded sleeve to the RJ45 socket tight (torque: 1.5 -1.7 Nm). Push the seal into the threaded sleeve.

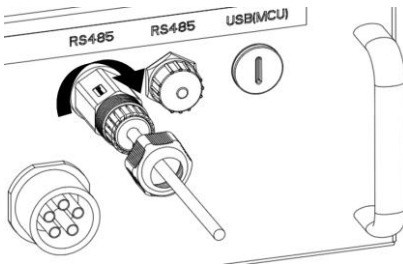

- Screw the swivel nut to the threaded sleeve tight (torque: 1.0-1.2 Nm).

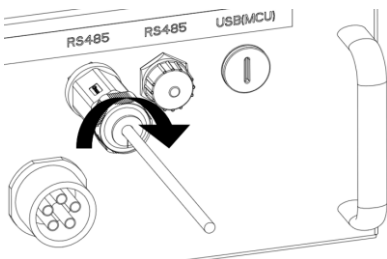

Disassemble the RJ45 plug:

1. Unscrew the swivel nut.

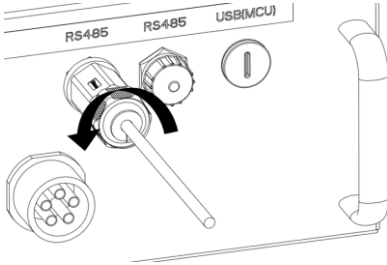

2. Unscrew the threaded sleeve.

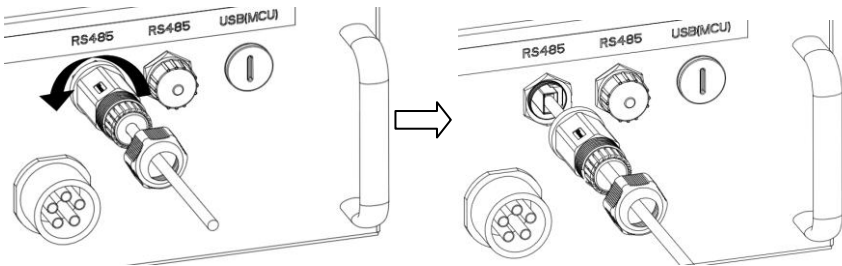

3. Remove the network cable and then screw the cap nut to the RJ45 keystone socket by hand.

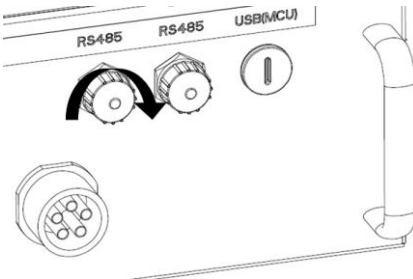

If necessary, an adjustable spanner can be used on-site during installation and dismantlement.

6.2 Updating the firmware via USB

If you have to update the firmware, use a screwdriver (blade width: 9 mm) to unscrew the M20 screw plugs located at the bottom of the enclosure.

7 Commissioning



NOTICE!

Risk of injury due to the faulty installation!

We strongly recommend carrying out preliminary checks before commissioning to avoid possible damage to the unit caused by faulty installation.

7.1 Electrical checks

Carry out the main electrical checks as follows:

- ① Check the PE connection with a multimeter: check that the inverter's exposed metal surface has an earth connection.



WARNING!

Danger to life due to the presence of DC-Voltage!

- Only touch the insulation of the PV array cables.
- Do not touch parts of the sub-structure and frame of the PV array.
- Wear personal protective equipment such as insulating gloves.

- ② Check the DC voltage values: check that the DC voltage of the strings does not exceed the permitted limits. Refer to the chapter "intended use" about designing the PV system (section 2.1.6) for the maximum allowed DC voltage.
- ③ Check the polarity of the DC voltage: make sure the DC voltage has the correct polarity.
- ④ Check the PV generator's insulation to earth with a multimeter: make sure that insulation resistance to earth is greater than 1 MOhm..



WARNING!

Danger to life due to the presence of AC-Voltage!

- Only touch the insulation of the AC cables.
- Wear personal protective equipment such as insulating gloves.

- ⑤ Check the grid voltage: check that the grid voltage at the point of connection of the inverter complies with the permitted value.

7.2 Mechanical checks

Carry out the main mechanical checks to ensure the inverter is waterproof as follows:

- ① Use sealing caps for tight sealing of unused DC input connectors.
- ② Make sure the RJ45 plug has been mounted properly. Make sure the cap nut on the unneeded RJ45 keystone socket has been solidly tightened.
- ③ Make sure the AC connector has been mounted properly.

7.3 Start-up

After finishing the electrical and mechanical checks, switch on the miniature circuit breaker and DC-switch in turn, the inverter starts up automatically.

Usually, there are three states during operation:

Waiting: When the initial voltage of the strings is greater than the minimum DC input voltage but lower than the start-up DC input voltage, the inverter is waiting for sufficient DC input voltage and cannot feed power into the grid.

Checking: When the initial voltage of the strings exceeds the start-up DC input voltage, the inverter will check feeding conditions at once. If there is anything wrong during checking, the inverter will switch to the "Fault" mode.

Normal: After checking, the inverter will switch to "Normal" state and feed power into the grid.

During periods of little or no sunlight, the inverter may continuously start up and shut down. This is due to insufficient power generated by the PV generator. If this fault occurs often, please call service.



Quick troubleshooting

If the inverter is in "Fault" mode, refer to chapter 11 "Troubleshooting".

8 Disconnecting the inverter from voltage sources

Before performing any work on the inverter, disconnect it from all voltage sources as described in this section. Always adhere strictly to the given sequence.

- 1 Disconnect the miniature circuit breaker and secure against reconnection.
- 2 Disconnect the DC-switch and secure against reconnection.
- 3 Use a current probe to ensure that no current is present in the DC cables.
- 4 Release and disconnect all DC connectors. To do so, insert a flat-blade screwdriver or an angled screwdriver (blade width: 3.5 mm) into one of the side slits and pull the DC connectors straight out. Do not pull on the cable.

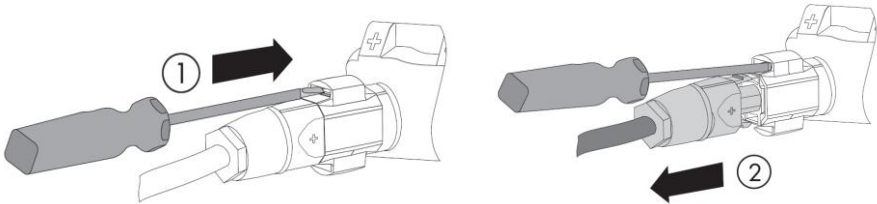

- 5 Release and disconnect the AC connector. Rotate the socket element counter-clockwise to open.

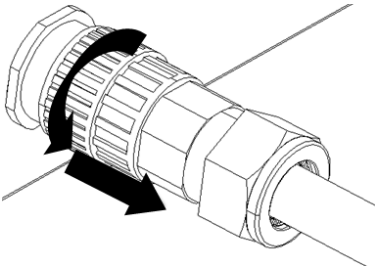

- 6 Wait until all LEDs and the display have gone out.



DANGER!

Danger to life due to high voltages!

The capacitors in the inverter take 5 minutes to discharge.

- Wait 5 minutes before opening the inverter.

9 Operating

9.1 Overview of the control panel

The inverter is equipped with a control panel which includes an liquid crystal display, three LED indicators and four control buttons. You can view the data and set the parameters of the inverter using the buttons.

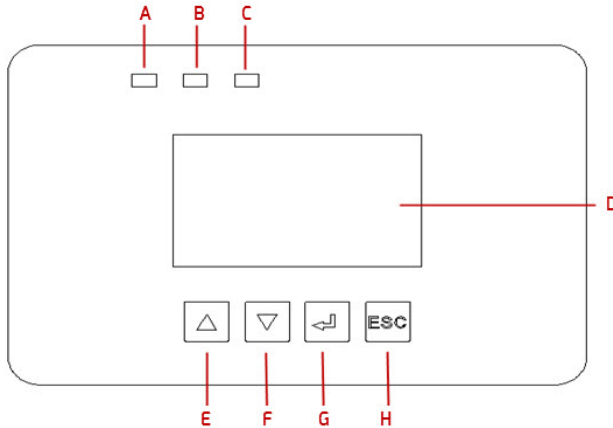

Object	Description
A	Normal (Green LED)
B	Fault (Red LED)
C	Communication (Bicolor LED)
D	Display
E	▲ (Up button)
F	▼ (Down button)
G	← (Enter button)
H	ESC button

9.2 LED indicators

The inverter is equipped with three LED including “green”, “red” and “bicolor” which provide information about the various operating status as follows.

Green LED:

The green LED is lit when the inverter is operating normally.

Red LED:

The red LED is lit when the inverter has stopped feeding power into the grid due to a fault. The corresponding error code will be shown on the display at the same time.

Bicolor LED:

The bicolor LED can blink green or red. It blinks during communication with other devices such as a PMU, Solarlog, etc. The bicolor LED blinks green when the PMU is sending information to the inverter, and blinks red when the inverter is sending information to the PMU. The LED will also blink green during a firmware update.

9.3 Display messages

Along with the various operating states, various messages may be shown on the display as follows.

State	Error code	Description	Causes
Initialization		Waiting	Initial PV voltage is between Min. DC input voltage and start-up DC input voltage of the inverter.
		Checking	The inverter is checking feeding conditions after initial PV voltage exceeds start-up DC input voltage of the inverter.
		Reconnect	The inverter is checking feeding conditions after the last fault has been solved.
Normal		Normal	The inverter is operating normally.
Fault	9	GFCI Fault	GFCI detection circuit is abnormal.
	8	AC HCT Fault	Output current sensor is abnormal.
	46	High DC Bus	The voltage of DC Bus exceeds the permitted upper limit.
	35	Utility Loss	The utility cannot be detected, which may be caused by no utility, grid disconnected, AC cable damage, fuse broken or island.
	40	Over Temp.	The internal temperature exceeds the permitted value.
	33	Fac Fault	The grid frequency lies outside the permitted range.
	34	Vac Fault	The grid voltage lies outside the permitted range.
	37	PV Overvoltage	The voltage of the strings exceeds the permitted upper limit.
	36	Ground Fault	The residual current exceeds the permitted upper limit.
	4	DC INJ. High	Output DC feed-in exceeds the permitted upper limit.

Fault	3	Rly-Check Fault	Output relay has failed.
	2	EEPROM R/W Fault	Reading or writing of EEPROM fails
	44	DC Inj. differs for M-S	A different value of DC feed-in has been detected by the master and slave MCU.
	43	Ground I differs for M-S	A different value of residual current has been detected by the master and slave MCU.
	42	Fac differs for M-S	A different value of grid frequency has been detected by the master and slave MCU.
	41	Vac differs for M-S	A different value of grid voltage has been detected by the master and slave MCU.
	11	M-S version unmatched	Different firmware version between the master and slave MCU.
	38	ISO Fault	The PV generator's insulation resistance to earth is below the permitted value, or the electrical insulation inside the inverter has failed.
	1	SPI Fault	Communication between the master and slave MCU has failed.
	39	Fan Lock	The fan or internal circuit has failed.
10	Device Fault	Unknown Error	

The latest 10 dated failure reports on the NS protection can be read. An interruption in the supply voltage of $\leq 3s$ does not result in any loss of failure reports (according to VDE-AR-N 4105).

9.4.2 Initial page

When the inverter starts up, the LCD will first display an initial page that shows the current safety standard information of the inverter. The page will display for about 5 seconds and then jump to the home page automatically.

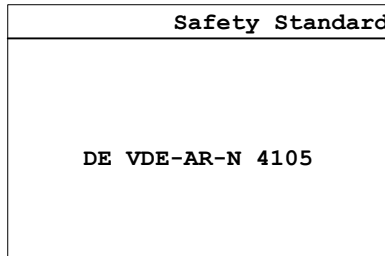



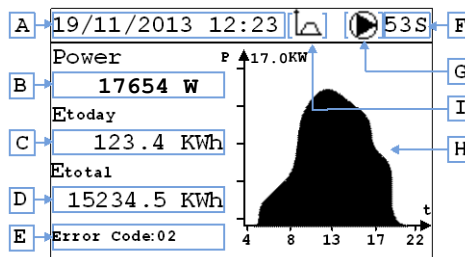

9.4.3 Home page

The home page shows some of the most important running data of inverter such as the real-time output power, today's energy, an error code, and the power graph.



The LCD will jump to the home page and the backlight will turn off when there is no button operation in 2 minutes.

Object	Description
A	Date & Time
B	Current output power
C	Daily energy
D	Total energy
E	Error code(*), see chapter 9.3
F	Checking time

G	Operating status:  waiting,  operating,  fault
H	Field area of output power from 4:00 to 22:00
I	Load limiting effective 

(*) The inverter will go into fault mode when the temperature is lower than -25°C. The LCD will show the error message "Temp. under -25°C".

9.4.4 Operation information

There are two operation pages which show the input and output information. Switch between the home page and operation pages by means of the "▲" or "▼" button.

Running Info		Running Info	
A → VacL1 236.1 V	IacL1 12.3 A	G → Vpv1 580.8 V	I → Ipv1 10.3 A
→ VacL2 235.5 V	IacL2 12.5 A	Vpv2 579.2 V	Ipv2 9.8 A
VacL3 237.8 V	IacL2 13.1 A	H → Ppv1 5802 W	Ppv2 5798 W → J
B → PF 1.00	Phase Leading → E		
C → Fac 50.01 Hz	Runtime 12 h → F		

Object	Description
A	Grid voltage
B	Power factor
C	Grid frequency
D	Output current
E	Phase leading or lagging
F	Running time of the current day
G	DC input voltage
H	DC input power
I	DC input current
J	DC input power

9.4.5 Main menu

Press the "←" button to enter the main menu from the home page.

Press the "▼" or "▲" button to select the menu item.

Press the "←" button to confirm.

Press the "ESC" button to return to the home page.

Menu
Statistics
Event Log
Settings
Device Info

9.4.6 Statistics

Press the "▲" or "▼" button to select the "Statistics" item of main menu and press "←" button to confirm.

Press the "▲" or "▼" button to select Days, Months or Years.

Press the "←" button to confirm.

Press the "▲" button one time to display the previous history record.

Press the "▼" button one time to display the next history record.

Press the "ESC" button to return to the menu.

Statistics	09/11/2013 Day Statistics
Days	Etoday 0.0 KWh
Months	Peak 0 W
Years	Runtime 0 h

9.4.7 Event log

Press the "▲" or "▼" button to select the "Event Log" item of main menu and press the "↵" button to confirm.

Press the "▲" or "▼" button to check the fault messages.

Press the "ESC" button to return to the menu.

Event Logs				
A	[1]	12/09/2013 08:45	E12	B
	[2]	11/09/2013 17:23	E03	
	[3]	10/08/2013 15:23	E43	
	[4]	07/07/2013 13:23	E45	
	[5]	02/06/2013 12:23	E01	

Object	Description
A	Date and time of the fault
B	Error code

9.4.8 Date&Time setting

Enter the sub-menu "Basic Setting" and press the "▼" or "▲" button to select the "Date&Time Setting" item of the "Settings" sub-menu and press the "↵" button to confirm.

Use the "▲" or "▼" button to set the year, month, day, hour and minute one by one.

Press the "↵" button to confirm.

Press the "ESC" button to return to the Basic Setting page.

Date&Time
DD/MM/YYYY hh:mm 19/11/2013 12:23

9.4.9 Language setting

Enter the sub-menu "Basic Setting" and press the "▼" or "▲" button to select the "Language Setting" and press the "↵" button to confirm.

Use the "▲" or "▼" to choose the language.

Press the "↵" button to confirm.

Press the "ESC" button to return to the Basic Setting page.

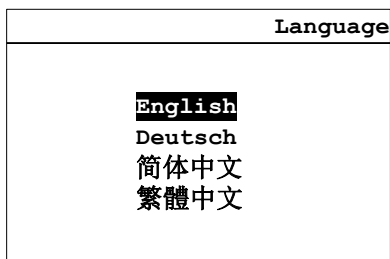

9.4.10 Contrast setting

Enter the sub-menu "Basic Setting" and press the "▼" or "▲" button to select the "Contrast Setting" and press the "↵" button to confirm.

Use the "▲" or "▼" to choose the LCD contrast.

Press the "↵" button to save.

Press the "ESC" button to return to the Basic Setting page.

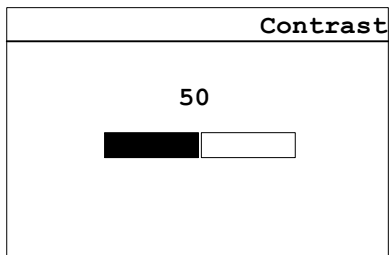

9.4.11 Safety setting

Enter the sub-menu "Advanced Setting" and press the "↵" button to input the password. The password is required if you want to change some one parameters. Please get the correct password from the service engineer. Enter the correct password and "↵" to enter the advanced setting page.

Then enter the sub-menu of "settings" and select the "Advanced setting" item and confirm. The password page is now displayed.

Press the "▲" or "▼" button to modify the password digit, press the "↵" button to change the next digit, and the advanced page is now displayed lastly.

Password	Advanced Setting
Password: 0 0 0 0	Safety Setting Overload Setting Active power control Reactive power control PV Mode Setting EEG Setting

To modify parameters, use the "▲" or "▼" button to modify the selected parameter and confirm with the "↵" button. Then the next parameter will be selected.

Press the "ESC" button to cancel.

Safety		Safety	
Standard:	DE VDE-AR-N 4105		
OVP2:	265.5 V	OFF2:	54.50 Hz
OVP1:	185.0 V	OFF1:	53.50 Hz
UVP1:	255.0 V	UFP1:	47.50 Hz
UVP2:	180.0 V	UFP2:	45.50 Hz
10Min-Mean:	180.5 V		

There are two pages of safety parameters. After modifying the last parameter of the first page, press "↵" to switch to the second page.



NOTICE!

- The safety of the grid may be influenced due to the wrong safety setting!
- The default parameters settings comply with the local regulations.
- Don't change the values of the monitored operational limits unless the utility provider agrees with your requirement!

9.4.12 Active power control

Enter the sub-menu "Advanced Setting" and press the "▼" or "▲" button to select the "Active power control" and press the "↵" button to set the state.

Use the "▲" or "▼" to choose the active power of the state.

Press the "↵" button to transfer to the inverter.

Press the "ESC" button to return to the Advanced Setting page.

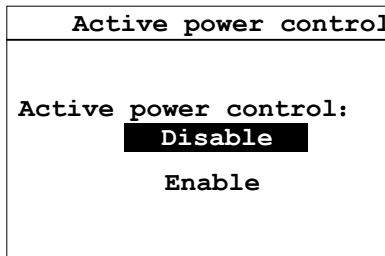

9.4.13 Reactive power control

Enter the sub-menu "Advanced Setting" and press the "▼" or "▲" button to select the "Reactive power control" and press the "↵" button to set the state.

Use the "▲" or "▼" to choose the reactive power of the state.

Press the "↵" button to transfer to the inverter.

Press the "ESC" button to return to the Advanced Setting page.

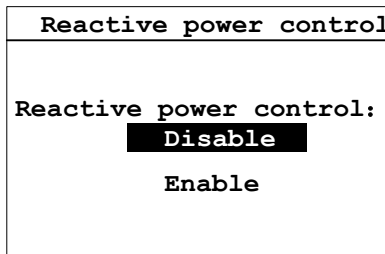

9.4.14 PV Mode Setting

Enter the sub-menu "Advanced Setting" and press the "▼" or "▲" button to select the "PV Mode Setting" and press the "↵" button to set the state.

Use the "▲" or "▼" to choose the PV Mode.

Press the "↵" button to transfer to the inverter.

Press the "ESC" button to return to the Advanced Setting page.

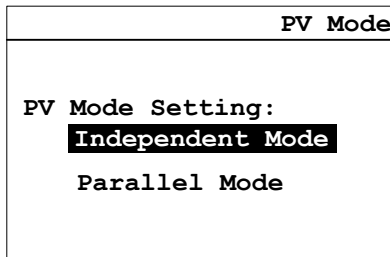

9.4.15 EEG Setting

Enter the sub-menu "Advanced Setting" and press the "▼" or "▲" button to select the "EEG Setting" and press the "↵" button to set the state.

Use the "▲" or "▼" to choose the EEG of the state.

Press the "↵" button to transfer to the inverter.

Press the "ESC" button to return to the Advanced Setting page.

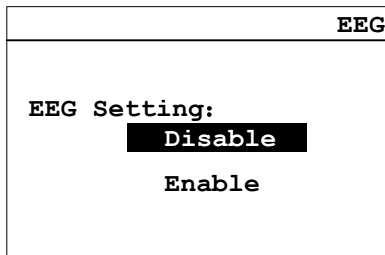

9.4.16 Communication Setting

Enter the sub-menu "Communication Setting" and press the "▼" or "▲" button to select the address and press the "↵" button to set the modbus communication address.

Use the "▲" or "▼" to choose the address.

Press the "↵" button to transfer to the inverter.

Press the "ESC" button to return to the menu.

Communication
Device Address: N

9.4.17 Device information

Press the "▼" or "▲" button to select the "Device Info" item of the main menu and press the "↵" button to confirm.

Press the "ESC" button to return to the menu.

Device Info
TYPE: TLC6K
S/N:1234567890123456
MCU:V1.00 B-list
HMI:20U13B20367B.A-list02
STD:DE VDE-AR-N 4105

9.4.18 Clear the history data

Enter the "safety setting" page, enter the correct password, and enter the data clear page.

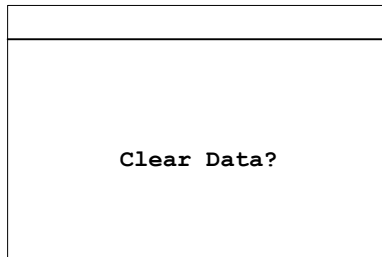

Press the "↵" button to confirm to clear the historical data. Press the "ESC" button to cancel.

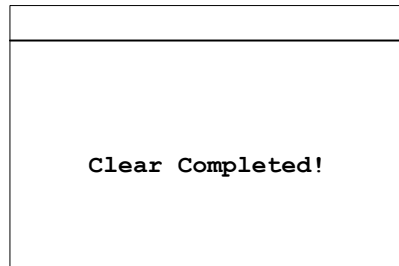
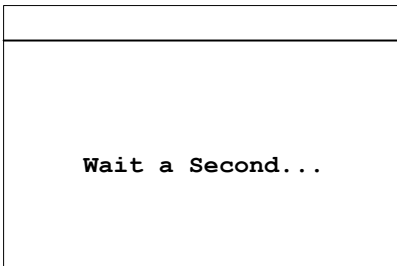

10 Technical data

10.1 DC input data

Type	TLC 10K	TLC 15K
Rated DC input power (P _{dc,r})	10400 W	15600 W
Max. recommended DC input power at STC ⁽¹⁾	11500 W	17250 W
Max. DC input voltage	1000 V ⁽²⁾ (3)	
Rated DC input voltage	640 V	
MPP voltage range	270 ... 950 V	
Full load MPP voltage range	320 ... 800 V	340 ... 800 V
Start-up DC input voltage	300 V	
Min feed-in DC voltage	270 V	
Max. DC input current (input A/B)	22 A/ 11A	22 A/ 22 A
I _{sc} PV, absolute Max. (input A/B)	32.4 A/ 16.2 A	32.4 A/ 32.4 A
Number of MPP trackers	2	
Strings per MPP tracker (input A/B)	2 / 2	
Turn on power	25 W	
DC-switch	Optional	

Type	TLC 17K	TLC 20K
Rated DC input power (Pdc,r)	17600 W	20800 W
Max. recommended DC input power at STC ⁽¹⁾	19500 W	23000 W
Max. DC input voltage	1000 V ^{(2) (3)}	
Rated DC input voltage	640 V	
MPP voltage range	270 ... 950 V	
Full load MPP voltage range	390 ... 800 V	450 ... 800 V
Start-up DC input voltage	300 V	
Min feed-in DC voltage	270 V	
Max. DC input current (input A/B)	22 A/ 22 A	
Isc PV, absolute Max. (input A/B)	32.4 A/ 32.4 A	
Number of MPP trackers	2	
Strings per MPP tracker (input A/B)	2 / 2	
Turn on power	25 W	
DC-switch	Optional	

- (1) For fixed systems with semi-optimal conditions.
- (2) When DC input Voltage is higher than 1000V, the inverter will alarm an error.
When DC input Voltage is below 950V, the inverter begins to check and connect to grid.
- (3) The 1000V firmware release varies by region. For details please talk to your local contact person.

10.2 AC output data

Type	TLC 10K	TLC 15K	TLC 17K	TLC 20K
Power connection	Three phase			
Rated output power	10000 W	15000 W	17000 W	20000 W
Max. output active power	10000 W	15000 W	17000 W	20000 W
Max. output apparent power	10000 VA	15000 VA	17000 VA	20000 VA
Rated grid voltage	3/N/PE, 220/380V 3/N/PE, 230/400V 3/N/PE, 240/415V			
AC voltage range ⁽¹⁾	160 V to 300 V			
Operating range at AC mains frequency 50 Hz ⁽²⁾	45 Hz to 55 Hz			
Operating range at AC mains frequency 60 Hz ⁽²⁾	55 Hz to 65 Hz			
Rated output current at 220 V	15.1 A	22.7 A	25.7 A	30 A
Rated output current at 230 V	14.5 A	21.7 A	24.6 A	28.9 A
Rated output current at 240 V	13.9A	20.8 A	23.6 A	27.7 A
Max. continuous output current	16A	24 A	25.8 A	30 A
Power factor	VDE-AR-N 4105	0.85ind - 0.85cap		
	Other safety	>0.97 at 20% load, >0.99 at 100% load		
Inrush current(peak and duration)	143A@89us	143A@89us	143A@89us	143A@89us
Max. output fault current (peak and duration)	60A@2.15ms	80A@2.15ms	86A@2.15ms	103A@2.15ms
Max. output overcurrent protection	300V,25A, TYPE C circuit breaker	300V, 40A, TYPE C circuit breaker	300V, 40A, TYPE C circuit breaker	300V, 40A, TYPE C circuit breaker
Harmonic distortion (THD) at Pac,r	< 3%			
Night-time power loss	< 1 W			
Standby power loss	< 12 W			

(1) The AC voltage range depends on the local safety standards.

(2) The AC frequency range depends on the local safety standards.

10.3 Safety regulations

Type	TLC 10K	TLC 15K/17K/20K
Internal overvoltage protection	Integrated	
DC insulation monitoring	Integrated	
DC feed-in monitoring	Integrated	
Grid monitoring	Integrated	
Residual current monitoring	Integrated (according to EN 62109-2)	
Islanding protection	Integrated (Three-phase monitoring)	
EMC immunity	EN61000-6-1, EN61000-6-2	
EMC emission	EN61000-6-3, EN61000-6-4	
Utility interference	EN61000-3-2, EN 61000-3-3	EN61000-3-11, EN 61000-3-12



INFORMATION

If you choose the standard VDE-AR-N 4105, please refer to information below.

- If a central NS protection device is used for power generation system, then the value of the rise-in-voltage protection $U >$ of 1.1 U_n presented in the integrated NS protection can be changed, but need password.

10.4 General data

Type	TLC 10K	TLC 15K/17K/20K
Net weight	48 Kg	
Dimensions L×W×D	758×500×175 mm	
Mounting environment	Indoor and Outdoor	
Mounting recommendation	Wall bracket	
Operating temperature range	-25... +60 °C	
Max. permissible value for relative humidity (non-condensing)	100%	
Max. operating altitude above mean sea level	2000 m	
Ingress protection	IP65(Electronics)	
	IP55(Fan)	
Climatic category	4K4H	
Protection class	I (in accordance with IEC 62103)	
Overvoltage category	DC input: II, AC output: III	
Topology	Transformerless	
Feed-in phases	3	
Cooling concept	Fans	
Noise	< 55 dB(A) @ 1m	< 60 dB(A) @ 1m
Display	240×160 Pixels, LCD	
Communication interfaces	RS485/USB	
Standard warranty	5 years	

10.5 Efficiency

The operating efficiency is shown for the three input voltages (V_{mppmax} , $V_{dc,r}$ and V_{mppmin}) graphically. In all cases the efficiency refers to the standardized power output ($P_{ac}/P_{ac,r}$). (According to EN 50524 (VDE 0126-13): 2008-10, cl. 4.5.3).

Notes: Values are based on rated grid voltage, $\cos(\varphi) = 1$ and an ambient temperature of 25°C.

10.5.1 Efficiency curve TLC 10K

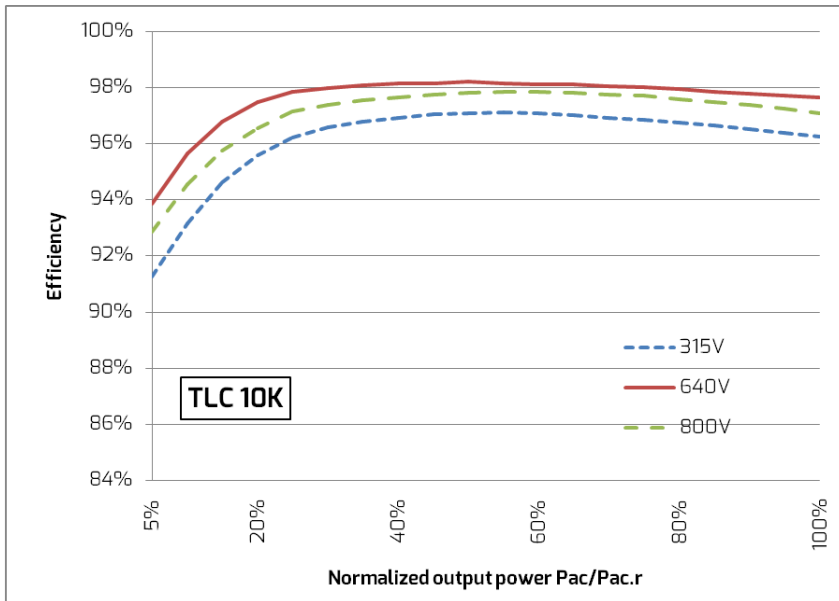

Max. efficiency, η_{max}	98.2 %
European weighted efficiency, η_{EU}	97.7 %

10.5.2 Efficiency curve TLC 15K

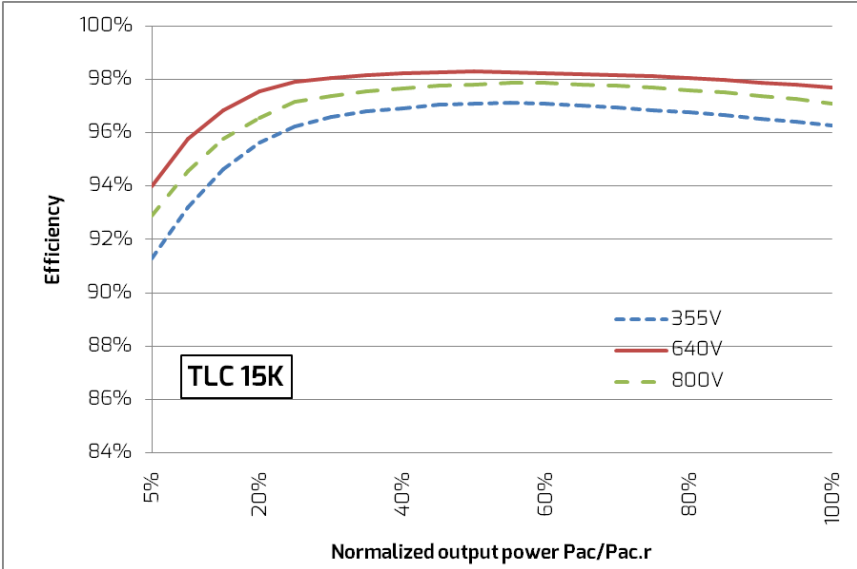

Max. efficiency, η_{max}	98.3 %
European weighted efficiency, η_{EU}	97.8 %

10.5.3 Efficiency curve TLC 17K

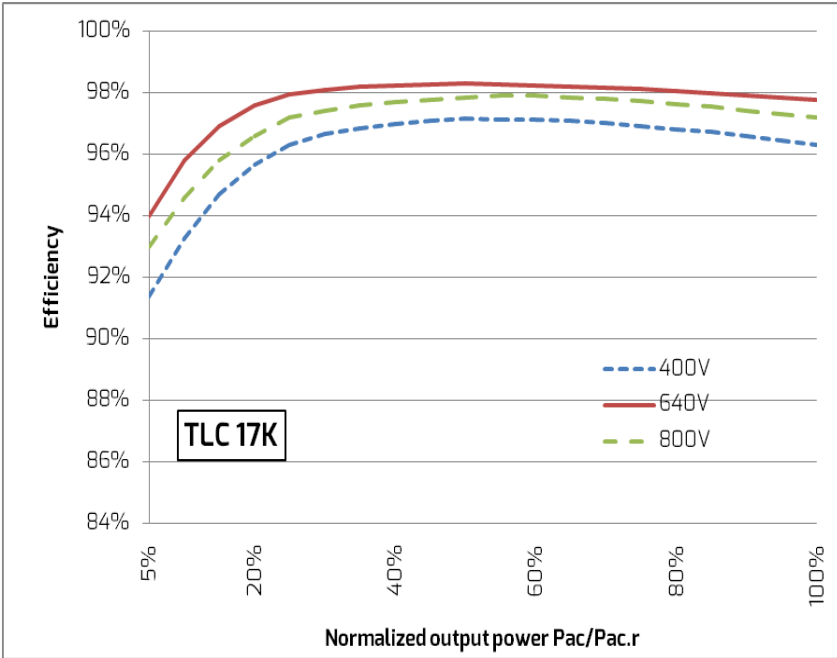

Max. efficiency, η_{max}	98.3 %
European weighted efficiency, η_{EU}	97.8 %

10.5.4 Efficiency curve TLC 20K

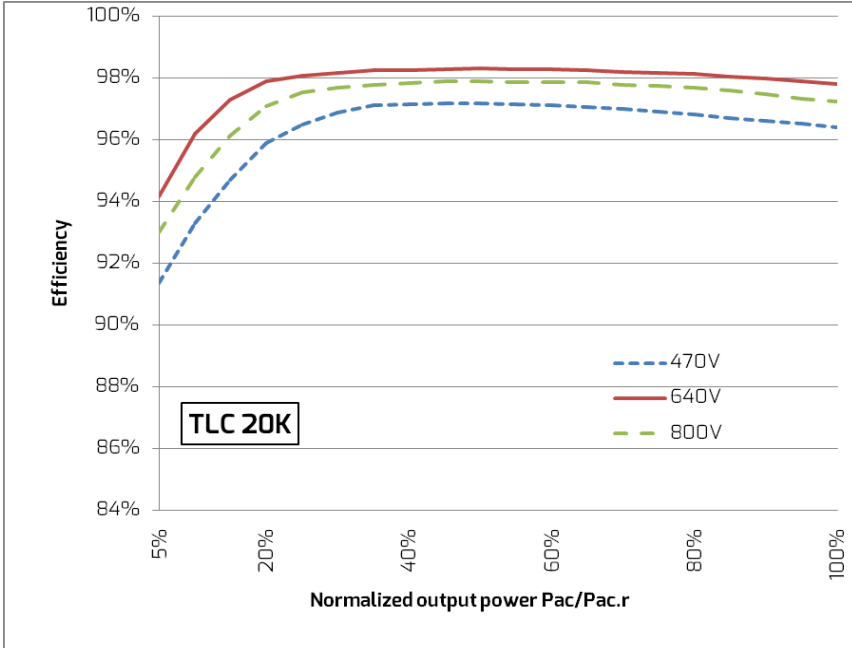

Max. efficiency, η_{max}	98.3 %
European weighted efficiency, η_{EU}	97.9 %

10.6 Power reduction

In order to ensure inverter operation under safe conditions, the device may automatically decrease power output.

Power reduction depends on many operating parameters including ambient temperature and input voltage, grid voltage, grid frequency and power available from the PV modules. This device can decrease power output during certain periods of the day according to these parameters.

Notes: Values based on rated grid voltage and $\cos(\varphi) = 1$.

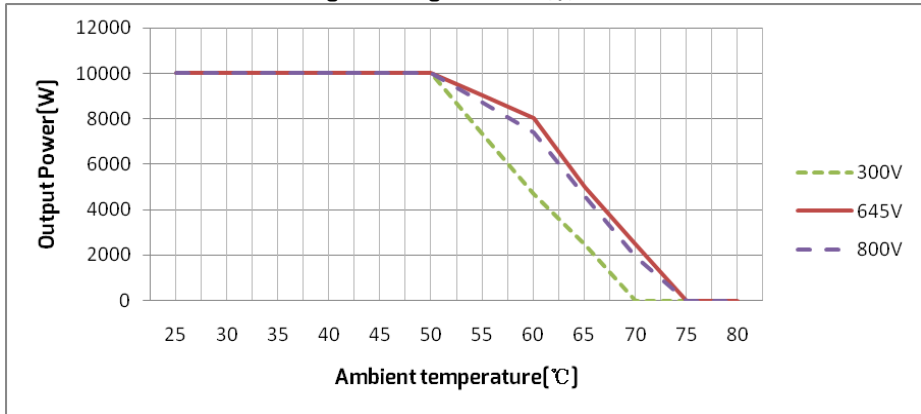

Power reduction with increased ambient temperature (TLC 10K)

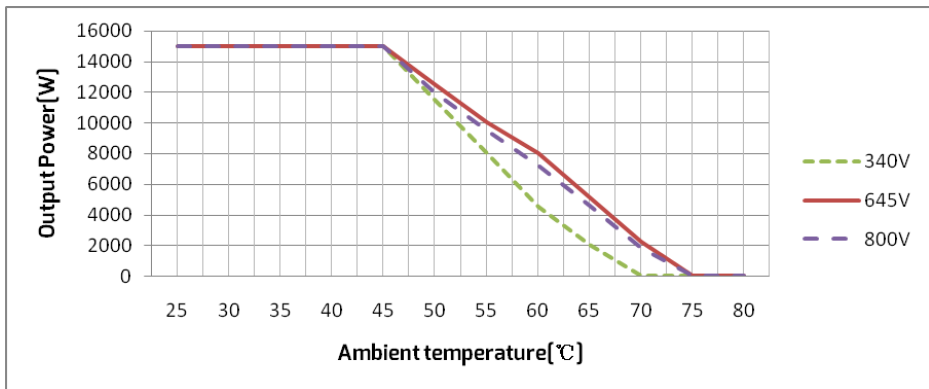

Power reduction with increased ambient temperature (TLC 15K)

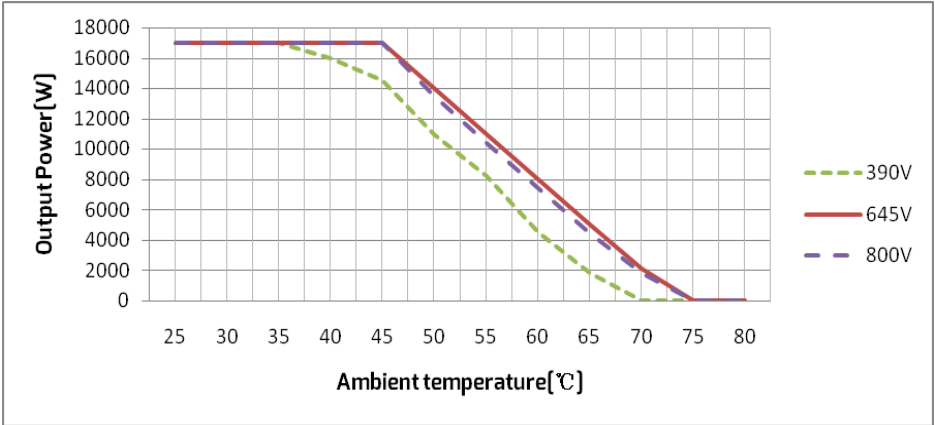

Power reduction with increased ambient temperature (TLC 17K)

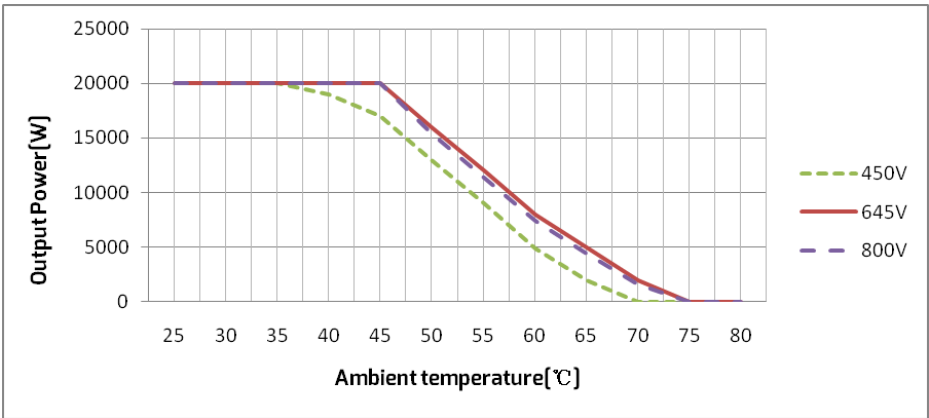

Power reduction with increased ambient temperature (TLC 20K)

11 Troubleshooting

When the PV system does not operate normally, we recommend the following solutions for quick troubleshooting. Eversol complies with the EU Low Voltage Directive 2006/95/EC and the EMC Directive 2004/108/EC. Eversol also complies with the requirement for safety and EMC in Australia and New Zealand market. The corresponding causes are described in section 9.3 "Display messages". The corresponding corrective measures are as follows:

Object	Error Code	Corrective measures
Resumable Fault	38	·Check the PV generator's insulation to earth, make sure that the insulation resistance to earth is greater than 1 MOhm; Otherwise, make a visual inspection of all PV cables and modules. ·Make sure the earth connection of the inverter is reliable. If this fault occurs often, contact the service.
	36	·Make sure the earth connection of the inverter is reliable. ·Make a visual inspection of all PV cables and modules. If this fault is still shown, please call service.
	46	·Check the open-circuit voltages of the strings, make sure it is lower than the Max. DC input voltage of the inverter; If the input voltage lies within the permitted range, and the fault still occurs, maybe the internal circuit has broken, please call service.
	37	·Check the open-circuit voltages of the strings, make sure it is lower than the Max. DC input voltage of the inverter. If the input voltage lies within the permitted range and the fault still occurs, please call service.
	41, 42 43, 44	·Disconnect the inverter from the grid and the PV generator, reconnect them after 3 minutes. If this fault is still being shown, please call service.

Resumable Fault	33	<ul style="list-style-type: none"> ·Check the grid frequency and observe how often major fluctuations occur. <p>If this fault is caused by frequent fluctuations, try to modify the operating parameters after informing the utility provider first.</p>
	35	<ul style="list-style-type: none"> ·Check the fuse and the triggering of the miniature circuit breaker in the distribution box. ·Check grid voltage, grid usability. ·Check AC cable, grid connection on the inverter. <p>If this fault is still being shown, please call service.</p>
	34	<ul style="list-style-type: none"> ·Check the grid voltage and grid connection on the inverter. ·Check the grid voltage at the point of connection of the inverter. <p>If the grid voltage is outside the permissible range due to local grid conditions, try to modify the values of the monitored operational limits after informing the electric utility company first.</p>
	40	<ul style="list-style-type: none"> ·Check whether the airflow to the heat sink is obstructed. ·Check whether the ambient temperature around the inverter is too high.
Permanent Fault	1,2,3,4, 8,9,10, 11, 39	<p>Disconnect the inverter from the grid and the PV generator, reconnect them after 3 minutes. If this fault is still being shown, please call service.</p>

12 Maintenance

Normally, the inverter needs no maintenance or calibration. Regularly inspect the inverter and the cables for visible damage. Disconnect the inverter from all power sources before cleaning. Clean the enclosure and display with a soft cloth. Ensure the heat sink at the rear of the inverter is not covered.

12.1 Cleaning the contacts of the DC-switch

Clean the contacts of the DC-switch once per year. Perform cleaning by cycling the switch to “1” and “0” positions 5 times. The DC-switch is located at the lower left of the enclosure.

12.2 Cleaning the heat sink



CAUTION!

Risk injury due to hot heat sink!

- The heat sink may exceed 70°C during operation. Do not touch the heat sink during operation.
- Wait approx. 30 minutes before cleaning until the heat sink has cooled down.

Clean the heat sink with pressurised air or a soft brush. Do not use aggressive chemicals, cleaning solvents or strong detergents.

For proper function and long service life, ensure free air circulation around the heat sink.

12.3 Cleaning the fans

This device is equipped with two fans, which are located on the right side. If the fan does not run normally has any unusual noise, or “Over Temperature in Inverter” is shown on the display, check or clean the fans. To do so, disconnect the inverter from all power sources, and wait approx. 30 minutes until the inverter has cooled down. Then the fan can be cleaned using a soft cloth or a brush.



CAUTION!

The heat sink and enclosure may exceed 70°C during operation!
Do not touch the heat sink and the enclosure during operation.

13 Recycling and disposal

Both the inverter and its transport packaging are predominantly made from recyclable raw materials.

Do not dispose of the defective inverter and its accessories with household waste.

Ensure that the defective inverter, its accessories and transport packaging are disposed of properly.

14 Contact

If you have any technical problems concerning our products, please contact Zeversolar service. We require the following information in order to provide you with the necessary assistance:

- Inverter device type
- Inverter serial number
- Type and number of connected PV modules
- Error code
- Mounting location

Zeversolar Factory Warranty

The current warranty conditions come enclosed with your device. They are also available online at www.zeversolar.com and can be downloaded and are available on paper from the usual sales channels if required.

Jiangsu Zeversolar New Energy Co., Ltd.

Tel.: +86 512 6937 0998

Fax: +86 512 6937 3159

Web: www.zeversolar.com

Factory add.: No.588 Gangxing Road, Yangzhong Jiangsu, China