

# **YASKAWA**

# **SOLECTRIA SOLAR**

**PVI 3800TL**

**PVI 5200TL**

**PVI 6600TL**

**PVI 7600TL**

## **Installation and Operation Manual**

**Revision C**

©2016, Yaskawa - Solectria Solar

This manual is subject to change.

Please check our website at <http://solectria.com/support/documentation/installation-operation-manuals/pvi-3800-7600tl-installation-and-operation-manual/> for the most recent version.

© Copyright – YASKAWA - SOLECTRIA SOLAR. - All rights reserved.

This manual accompanies our equipment for use by the end users. The technical instructions and illustrations contained in this manual are to be treated as confidential and no part may be reproduced without the prior written permission of YASKAWA - SOLECTRIA SOLAR. Service engineers and end users may not divulge the information contained herein or use this manual for purposes other than those strictly connected with correct use of the equipment. All information and specifications are subject to change without notice.

# Table of Contents

<b>1</b>	<b>General Safety Instructions</b>	<b>6</b>
1.1	Safety Symbols and Terminology Definitions	7
1.2	Safety Instructions	8
<b>2</b>	<b>Introduction</b>	<b>10</b>
2.1	System	10
2.2	Data Monitoring and Communication	11
2.3	Technical Structure of the Inverter	11
2.4	Ambient Temperature	12
2.5	Inverter DC Input Voltage Range	12
2.6	Efficiency	13
2.7	Equipment Overview	14
2.8	Inverter Nameplate and Safety Labels	16
<b>3</b>	<b>Installation</b>	<b>20</b>
3.1	Visual Inspection	21
3.2	Installation Location	21
3.3	Mounting the Inverter	22
3.4	Required Torques for PVI Inverters	24
<b>4</b>	<b>Electrical Connections</b>	<b>25</b>
4.1	General Safety	25
4.2	Utility AC Voltage	26
4.3	AC Circuit Breaker Requirements	28
4.4	Grounding Terminals	28
4.5	Lightning and Surge Protection	28
4.6	Multiple Inverters	28
4.7	PV String Considerations	29
4.8	Inverter Connections	30
4.8.1	General Information	30
4.8.2	Opening the Wiring Box Cover	32
4.8.3	Wiring Box Conduit Openings	33
4.8.4	PV Array String Input Connections	34
4.8.5	Selecting PV String Fuse(s)	37
4.8.6	Inverter AC Output Wire Connections	40
4.8.7	Inverter RS-485 Communication Connections	44
<b>5</b>	<b>Commissioning the PV system</b>	<b>46</b>
5.1	Status LEDs	47
5.2	Display and Keypad	47

5.2.1	Components	47
5.2.2	Display Layout	47
5.2.3	Keypad	48
5.2.4	General Menu Structure	48
5.2.5	Menu Tree	49
5.3	Inverter Turn-On Procedure	51
5.4	Inverter Turn-Off Procedure	51
5.5	Standard Initial Commissioning	51
5.5.1	Brief Overview of the Commissioning Steps	51
5.5.2	Detailed Description of the Commissioning Steps	52
5.6	Setting Values	54
<b>6</b>	<b>Production Information</b>	<b>56</b>
6.1	Overview	56
6.2	Current Data	57
6.3	Other Statistics	58
6.4	Deleting Statistics	60
<b>7</b>	<b>Settings</b>	<b>61</b>
7.1	Overview	61
7.2	Installation Settings	61
7.2.1	Date and Time	62
7.2.2	Date and Time Formats	62
7.2.3	Contrast	63
7.2.4	Grid Selection	63
7.2.5	RS-485	64
7.3	Grid Feed-In Settings	65
7.4	Options Settings	66
7.4.1	Shading	66
7.4.2	AFCI Setting	67
7.4.3	AFCI Self Test	68
7.4.4	Arc Fault Clear	68
7.5	Standard Menu	69
<b>8</b>	<b>Diagnosis and Maintenance</b>	<b>70</b>
8.1	Operating States	70
8.1.1	Types of Operating States	70
8.1.2	Factors Influencing the Operating State	70
8.1.3	Display of the Current Operating State	71
8.2	Event Log	72

8.2.1	Overview	72
8.2.2	External Events Menu	72
8.2.3	Change Events Menu	73
8.3	Troubleshooting and Correction	74
8.3.1	External Events / Insulation and Grounding Failures	74
8.3.2	Internal Failures	76
8.3.3	Other LED and Display Messages	77
8.4	Displaying Grid Settings	77
8.5	Internal Log	78
8.6	Maintenance	78
<b>9</b>	<b>Repair</b>	<b>78</b>
<b>10</b>	<b>Removal, Transport, Storage, Disposal</b>	<b>79</b>
10.1	Removal	79
10.2	Transport	79
10.3	Storage	79
10.4	Disposal	79
<b>11.</b>	<b>Technical Data</b>	<b>80</b>
11.1	FCC Compliance Information	83
11.2	Canadian Compliance Information	83
<b>12</b>	<b>Appendix</b>	<b>84</b>
12.1	Overview of Setting Options	84
12.2	Order Numbers	85
12.3	Overview of Menu Structure	85
12.3.1	"Go to menu" Function	85
12.3.2	Installation Settings (100)	86
12.3.3	Shading (210)	87
12.3.4	Production Information (400)	87
12.3.5	Diagnostics and Alarms (600)	91
12.3.6	Software Version/Inverter Data (700)	91
12.3.7	Standard Menu (800)	92
<b>13</b>	<b>Glossary</b>	<b>93</b>
<b>14</b>	<b>Certificates</b>	<b>95</b>
<b>15</b>	<b>Warranty</b>	<b>96</b>

## Figures

1.	PVI inverter output power vs ambient temperature curve	12
2.	PVI 3800TL DC input Voltage Range	12
3.	PVI 5200TL/PVI 6600TL/PVI 7600TL PV input DC Voltage Range	13
4.	PVI 3800TL Efficiency Plot	13
5.	PVI 5200TL/PVI 6600TL/PVI 7600TL Efficiency Plot	14
6.	Exterior view of inverter's main components	14
7.	Lockable DC Disconnect	15
8.	Nameplate Label and Barcode Label Location	16
9.	Location of Caution Labels	17
10.	Dimensions of PVI 3800TL inverter	18
11.	Dimensions of PVI 5200TL/PVI 6600TL/PVI 7600TL inverters	18
12.	Wiring box connection	20
13.	Inverter clearances	22
14.	Dimension drawing of mounting plate	23
15.	Installing the mounting bracket and inverter on a wood stud wall	23
16.	240V / 120V Split Phase AC Grid	26
17.	208V Delta AC Grid	26
18.	208V / 120V WYE AC Grid	27
19.	240V Delta AC Grid	27
20.	240V / 120V Stinger leg AC Grid	27
21.	480V Delta AC Grid	27
22.	480V / 277V WYE AC Grid	27
23.	PVI 3800TL Inverter electrical diagram	30
24.	PVI 5200TL/PVI 6600TL/PVI 7600TL Inverter electrical diagram	30
25.	Removing the wiring box cover	31
26.	Wiring box conduit opening locations	32
27.	Wiring box conduit plug removal	32
28.	Conduit installation and wiring routing	33
29.	Wiring box - PV input connections	35
30.	Selecting PV string fuses	36
31.	String fuse replacement procedure	38
32.	Conduit installation and AC wiring routing	40
33.	PVI 3800TL - AC voltage loss in different wire sizes and lengths	41
34.	PVI 5200TL/PVI 6600TL/PVI 7600TL - AC voltage loss with different wire sizes and lengths	41
35.	Wiring box AC assembly - terminal labeling	42
36.	Inverter RS-485 system diagram	43
37.	RS-485 termination jumper	44
38.	RS-485 connector pin-out	44
39.	SolrenView gateway HMI	45

# IMPORTANT SAFETY INSTRUCTIONS

## SAVE THESE INSTRUCTIONS

### 1 General Safety Instructions

This manual contains important instructions for Solectria models PVI 3800TL, PVI 5200TL, PVI 6600TL and PVI 7600TL that should be followed during installation and maintenance of the inverter.

Solectria models PVI 3800TL, PVI 5200TL, PVI 6600TL and PVI 7600TL inverters are designed and tested to meet all applicable North American and International safety standards. However, like all electrical and electronic equipment, safety precautions must be observed and followed during installation and operation of Solectria inverters to reduce the risk of personal injury and to ensure a safe installation.

Installation, commissioning, service, and maintenance of Solectria models PVI 3800TL, PVI 5200TL, PVI 6600TL and PVI 7600TL inverters must only be performed by qualified personnel that are licensed and/or satisfy state and local jurisdiction regulations.

Before starting installation or commissioning of the Solectria PVI 3800TL, PVI 5200TL, PVI 6600TL and PVI 7600TL, read through the entire manual and note all DANGER! WARNING! CAUTION!, and NOTICE! statements.

All US electrical installations must comply and be in accordance with all the state, local, utility regulations, and National Electrical Code ANSI/NFPA 70.

For installations in Canada, please ensure these are done in accordance with applicable Canadian standards.

Ce guide contient d'importantes instructions concernant les onduleurs solaires Solectria modèle PVI 3800TL, PVI 5200TL, PVI 6600TL et PVI 7600TL qui doivent être observées au cours de l'installation et de l'entretien de l'onduleur.

Les onduleurs solaires Solectria modèle PVI 3800TL, PVI 5200TL, PVI 6600TL et PVI 7600TL sont conçus et testés pour répondre à toutes les normes de sécurité nord-américaines et internationales applicables. Cependant, comme pour tous les équipements électriques et électroniques, des mesures de sécurité doivent être respectées et observées durant l'installation et l'exploitation des onduleurs Solectria afin de réduire le risque de préjudice corporel et de garantir la sécurité de l'installation.

L'installation, la mise en service, l'entretien et la maintenance des onduleurs solaires Solectria modèle PVI 3800TL, PVI 5200TL, PVI 6600TL et PVI 7600TL doivent être entreprises uniquement par un personnel qualifié autorisé et/ou répondant aux critères des règlements locaux ou nationaux applicables.

Lisez l'intégralité du manuel et prenez note de toutes les déclarations relatives à la sécurité sous les rubriques intitulées DANGER ! AVERTISSEMENT ! PRUDENCE ! et AVIS ! avant de commencer l'installation ou la mise en service des onduleurs solaires PVI 3800TL, PVI 5200TL, PVI 6600TL et PVI 7600TL.

Toutes les installations électriques nord-américaines doivent être conformes et respecter tous les règlements des services publics, nationaux, locaux ainsi que le National Electrical Code ANSI/NFPA 70.

Pour toute installation au Canada, veuillez vous assurer que les installations sont conformes aux normes canadiennes applicables.

## 1.1 Safety Symbols and Terminology Definitions



DANGER indicates a hazardous situation which, if not avoided, will result in death or serious injury.

DANGER indique une situation dangereuse qui, si elle n'est pas évitée, est susceptible de provoquer un décès ou des blessures graves.



WARNING indicates a hazardous situation which, if not avoided, could result in death or serious injury.

AVERTISSEMENT indique une situation dangereuse qui, si elle n'est pas évitée, est susceptible de provoquer un décès ou des blessures graves.



CAUTION indicates a hazardous situation which, if not avoided, could result in minor or moderate injury.

PRUDENCE indique une situation dangereuse qui, si elle n'est pas évitée, est susceptible de provoquer des blessures légères ou de degré moyen.



NOTICE indicates a situation that can result in property damage if not avoided.

AVIS indique une situation susceptible de provoquer des dommages à la propriété, si elle n'est pas évitée.



INFORMATION provided that when known and used will ensure optimal operation of the system.

La connaissance et l'utilisation des INFORMATIONS fournies garantissent un fonctionnement optimal du système.



HIGH VOLTAGE WARNING! Indicates hazardous high voltages are present, which, if not avoided, will result in death or serious injury. Thus, only authorized and trained personnel should install and/or maintain this product.

AVERTISSEMENT HAUTE TENSION! indique la présence de hautes tensions présentant un danger susceptibles de provoquer un décès ou des blessures graves si elles ne sont pas évitées. Par conséquent, l'installation et/ou l'entretien de ce produit doivent être entreprises uniquement par un personnel autorisé et formé.





Hot surface

Surface chaude



Equipment grounding conductor (PE)

(PE) Équipement conducteur de terre



Wait for a prescribed amount of time before engaging in the indicated action.

Patiencez le délai requis avant d'entreprendre l'action indiquée.

## 1.2 Safety Instructions

The inverter installation must be performed by an authorized electrician in accordance with the local and National Electrical Code ANSI/NFPA 70 and OSHA requirements.

- The inverter section contains no user-serviceable parts. For all service and maintenance, the inverter should be returned to a Solectria Renewables, LLC.
- Read all of these instructions, cautions, and warnings for the Solectria inverter and associated PV array documentation.
- Before connecting the Solectria inverter to the AC distribution grid, approval must be received by the appropriate local utility as required by national and state interconnection regulations, and must be connected only by qualified personnel.
- In operation, the inverter wiring and connections can have hazardous high voltages and currents present, thus only authorized and qualified personnel shall install and/or maintain the inverter.
- In some operation instances, the inverter chassis and heatsink surfaces may become hot.
- PV solar arrays produce hazardous voltages and currents when exposed to light which can create an electrical shock hazard. Use dark opaque sheets to cover the PV solar array before wiring or connecting cable terminations.

L'installation et la mise en service doivent être effectuées par un électricien autorisé conformément aux exigences locales et nationales ainsi qu'au National Electrical Code ANSI/NFPA 70 et condition nécessaire OSHA.

- L'onduleur ne comporte aucune pièce pouvant être réparée par l'utilisateur. Afin de réduire les risques de choc électrique, contactez le personnel d'entretien qualifié de l'usine à propos des opérations d'entretien de Solectria Renewables, LLC.
- Lisez toutes les instructions, rubriques Prudence et Avertissement de l'onduleur Solectria, ainsi que la documentation sur le panneau photovoltaïque associé.

- Avant de connecter l'onduleur solaire Solectria au réseau de distribution du courant alternatif (CA), une autorisation doit être obtenue de la part des services publics locaux de tutelle, conformément aux règlements concernant l'interconnexion nationale et locale. La connexion ne doit être effectuée que par un personnel qualifié.
- Des courants et des tensions de hautes intensités dangereuses peuvent être présents dans le câblage et les connexions de l'onduleur en marche, par conséquent, l'installation et/ou la maintenance de l'onduleur doivent être entreprises uniquement par un personnel autorisé et qualifié.
- Sous certains régimes de fonctionnement, le châssis de l'onduleur et les surfaces des dissipateurs de chaleur peuvent devenir chaud.
- Les panneaux solaires photovoltaïques produisent tensions et courants dangereux lorsqu'ils sont exposés à la lumière et constituent un danger de choc électrique. Couvrez le panneau solaire photovoltaïque à l'aide de morceaux de tissu opaques et foncés avant tout câblage ou connexion des terminaisons de câble.

## 2 Introduction

With this device you have acquired an inverter for connection of a photovoltaic system to the grid. This inverter is characterized by an advanced housing design and state-of-the-art high-frequency technology, which enable the highest levels of efficiency and longest life.

The inverter includes key features and capabilities, such as Anti-Islanding protection, LCD, and RS-485 interfaces.

The inverter is usable indoors and outdoors. It meets the requirements of ANSI/NFPA 70, NEC 690.5, UL 1741, IEEE 1547 and IEEE 1547.1 for parallel operation of power generation plants on low-voltage network of regional electrical utility companies.

### Anti Islanding

This inverter includes Active Anti-Islanding detection as required by UL1741/IEEE1547. The inverter will automatically make small variations in reactive power output in order to detect a possible islanding condition. If the grid is stable, these small variations will have negligible effects on system voltage and frequency. However, in an islanded condition the small amount of reactive power changes will force the system voltage or frequency to change significantly, which will trigger the inverter to shut down.

In the following technical description, the precise functions are explained to the installer, as well as the user, which are required for the installation, operational start-up and handling of the inverter.

## 2.1 System

The content of renewable energy with respect to overall power consumption worldwide is increasing annually by approximately 25%. The reason for this rise can be primarily attributed to the constantly increasing demand for power, the increasing interest in environmentally friendly technologies, as well as the increasing costs of non-renewable energy.

By the use of renewable energy sources, the earth's atmosphere can be enormously relieved of increases in CO<sub>2</sub> and other harmful gases which result from power generation.

The solar inverter converts direct current from the solar cells into alternating current. This enables you to feed your self-produced solar energy into the public grid.

Thanks to efficient MPP tracking, maximum capacity utilization of the solar energy plant is ensured even in cases of misty and cloudy skies.

The string concept means that PV modules are always connected in series (in a string) and/or that strings with the same voltage are connected in parallel to the solar inverter with the aim of significantly reducing the photovoltaic system's cabling requirements.

The fact that the modules are connected in strings also means that the photovoltaic system can be perfectly matched to the solar inverter's input voltage range.

The inverter is transformerless type without galvanic isolation. Therefore, the inverter may only be operated with ungrounded PV arrays. Furthermore, the PV array must be installed in accordance with the NEC 690.35 (Ungrounded Photovoltaic Power Systems) and the locally valid regulations for ungrounded PV arrays. Additionally, the PV array (PV modules and cabling) must have protective insulation and the PV modules used must be suitable for use with this inverter. PV modules with a high capacity to ground may only be used if the array coupling capacity does not exceed 1,200 nF with 60Hz grid.

## 2.2 Data Monitoring and Communication

The integrated data display, processing and communication of the device enables easy operation of the solar inverter. Monitoring of the operational status and signaling of operational failures are capable of being called up over the device display. The data interfaces enable the downloading of data which can be evaluated with the aid of a PC system and allow continuous recording of operating data.

The best way of accessing this functionality is via a monitoring system, such as SolrenView, connected to your inverter.

The read-out of the data on the display is possible when the inverter is connected to AC voltage.

## 2.3 Technical Structure of the Inverter

The photovoltaic voltage is adjusted so that the maximum power output of the PV modules is also achieved with different solar irradiation levels and temperatures (MPP Tracking). These inverters have quite wide MPP range of suit for variety of PV modules by a variety of manufacturers. Measures must be taken to ensure that the maximum no-load voltage of 600 V is never exceeded. Please note that the maximum no-load voltage will occur at the lowest temperatures anticipated. You will find more detailed information about temperature dependency in the data sheet for the PV modules.

The high-quality aluminum casing corresponds to protection degree NEMA 4 / IP65 (water-jet proof and dust-proof) and is protected by an anti-corrosion finish. The heat sink on the inverters is designed in such a way that operation of the inverter is possible at ambient temperatures from -13°F to +122°F (-25°C to +50°C) at full power and optimal efficiency for either 240 V<sub>ac</sub> or 208 V<sub>ac</sub> AC grids.

Metal fins designed into the rear side of the inverter chassis are used to dissipate heat and protect the unit. An internal temperature control protects the interior of the device. In case of high ambient temperatures, the maximum transferable power is limited.

The solar inverter is controlled by microcontrollers which provide interface communication and the values and messages on the front-panel display.

AC grid monitoring is done by an independent dedicated micro controller set up to meet the requirements of UL 1741 / IEEE 1547. This enables a connection of the solar inverter to the in-house grid.

Operator protection requirements are met by electrically isolating the grid from the PV module. The electrical isolation between the grid and the PV module is equivalent to basic insulation. Maximum operator protection is ensured by reinforced isolation between the grid, PV modules and accessible interfaces (display, RS-485 interface and fan port). Relevant standards concerning electromagnetic compatibility (EMC) and safety are fulfilled.

The solar inverter is functional in grid-parallel operation exclusively. An automatic Anti-Islanding function, guarantees secure disconnection in case of circuit isolation or interruptions in power supply and avoid isolated operation.

### DC Arc Fault Detection

The PVI 3800-7600TL inverters include DC Arc fault detection compliant with UL 1699B. The inverter detects electrical noise that typically accompanies a DC series arc. The inverter will shut down should the arc fault sensor detect a series arc.

## DC Ground Fault Protection

The PVI 3800-7600TL inverters include residual current detection as part of the DC ground fault detection method as required by UL1741. If there is a ground fault in the array, the inverter will shutdown and display an error until the fault is cleared. GFDI Trip Limit: 300mA

## 2.4 Ambient Temperature

The inverter can be operated in ambient temperatures between -13°F to 158°F (-25°C to +70°C). The following diagram illustrates how the power of the inverter is derated depending on ambient temperature.

The device should be installed in a well-ventilated, cool and dry location.

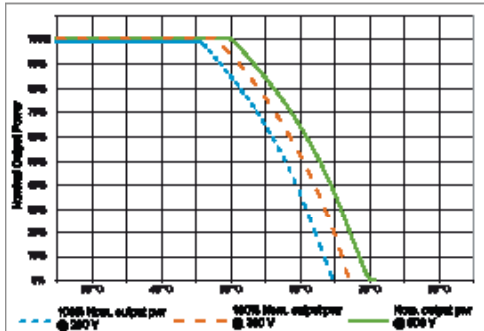

Figure 1 demonstrates typical behavior for PVI 3800-7600TL series inverters.

Figure 1: Solectria PVI 3800-7600TL inverter output power vs ambient temperature curve

## 2.5 Inverter DC Input Voltage Range

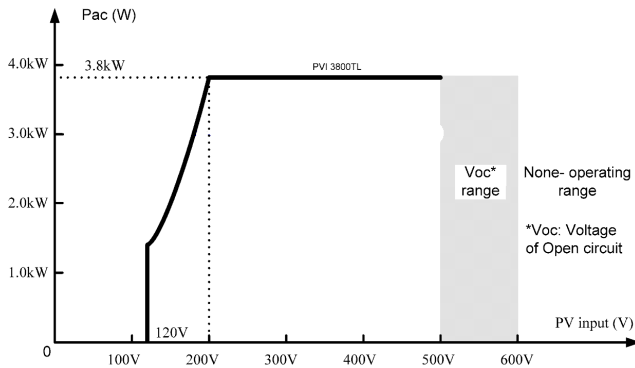

Figure 2: Solectria PVI 3800TL DC Input Voltage Range

Notice: Start up voltage is  $150 V_{dc}$ ; full power MPPT voltage is  $200 V_{dc}$

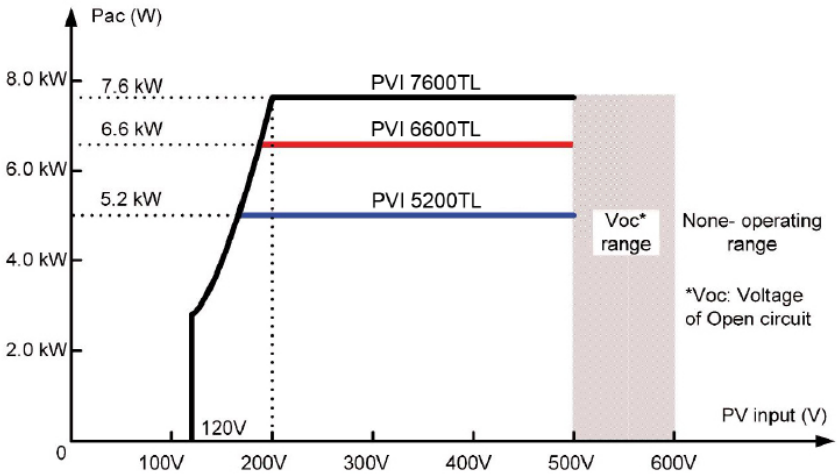

Figure 3: PVI 5200TL, PVI 6600TL and PVI 7600TL PV input DC voltage range

## 2.6 Efficiency

The best efficiency of the inverter is obtained at input voltages  $> 320V_{dc}$  for  $208V_{ac}$  grid, and input voltages  $> 380V_{dc}$  for  $240V_{ac}$  grid.

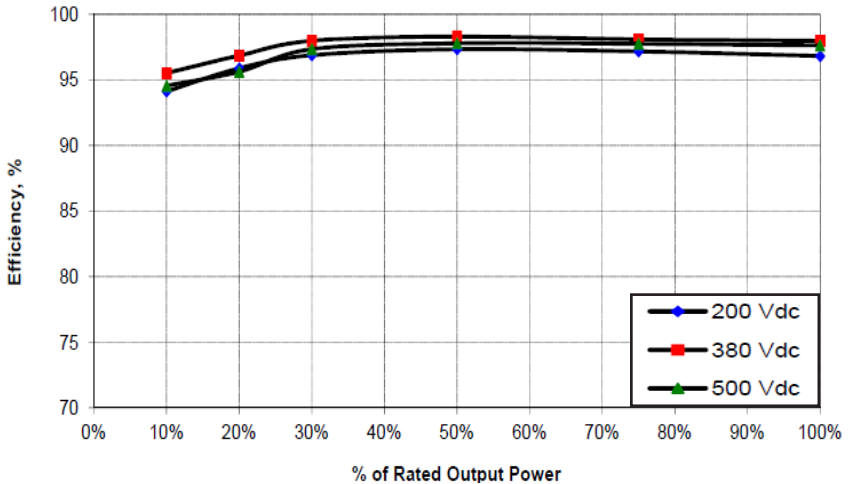

Figure 4: PVI 3800TL Efficiency Plot at  $240V_{ac}$

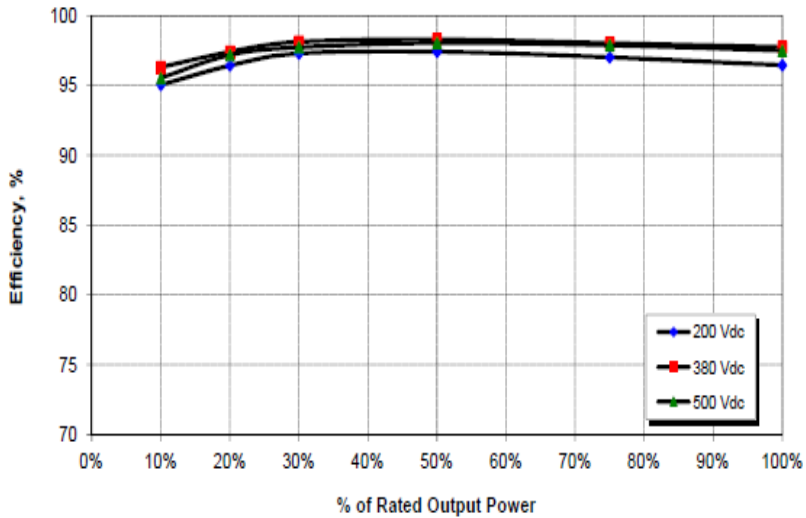
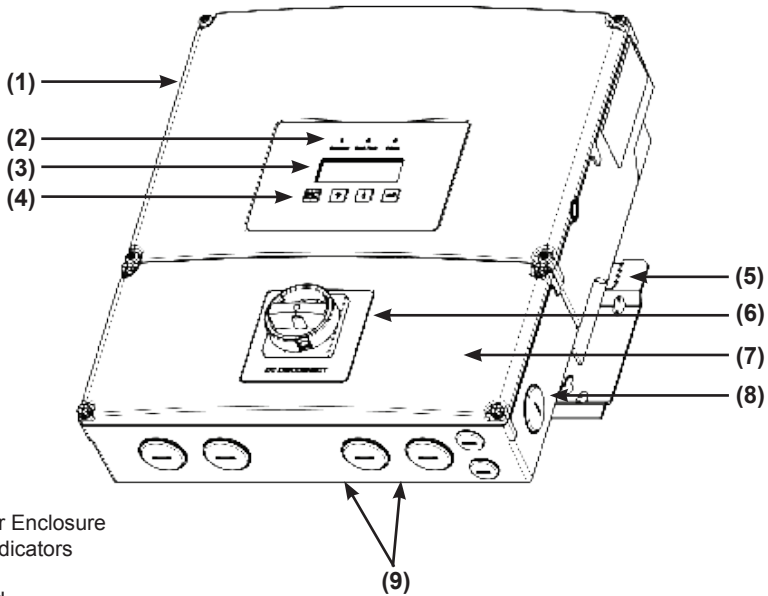

Figure 5: PVI 5200TL, PVI 6600TL and PVI 7600TL efficiency plot at 240V<sub>ac</sub>

## 2.7 Equipment Overview



- (1) Inverter Enclosure
- (2) LED Indicators
- (3) LCD
- (4) Keypad
- (5) Mounting Bracket
- (6) Lockable DC Disconnect
- (7) Wiring Box Cover
- (8) Wiring Box
- (9) Conduit Plugs

Figure 6: Exterior view of inverter main components

A further description of the equipment features:

(1) Inverter Enclosure - This section is sealed at the factory and there are no user-serviceable parts inside. All wiring to install the inverter is done in the wiring compartment.

(2) LED Indicators - The three LED indicators show errors or status as described in Section 5.

(3) LCD - The 20 character, 4 line LCD shows important messages regarding the inverter status and performance.

(4) Display Control Keys - These 4 keys allow the user to access status and performance information and to change settings via the display.

(5) Mounting Bracket - The inverter ships with a mounting bracket that allows for easy installation of the inverter to a wall.

(6) Lockable DC Disconnect - The DC disconnect is lockable and allows DC power to be disconnected from the inverter. See figure 7 below.

(7) Wiring Box Cover - This is the cover for the wiring compartment. The removal procedure is shown on page 29. Please note the DC disconnect must be in the OFF position before this cover can be removed.

(8) Wiring Box - This is the compartment where all the wiring for the inverter inputs and outputs plus the RS-485 communication is done.

(9) Conduit Opening - There are six - 1" conduit openings and two - 1/2" conduit openings. Each conduit opening comes fitted with a conduit plug that should be removed before installing conduit fittings. Conduit fittings need to be water tight with a NEMA 4, 4X, 6, or 6X rating.

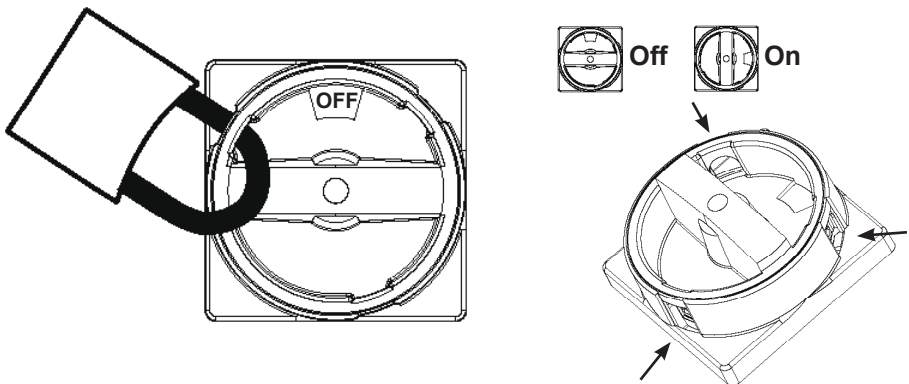
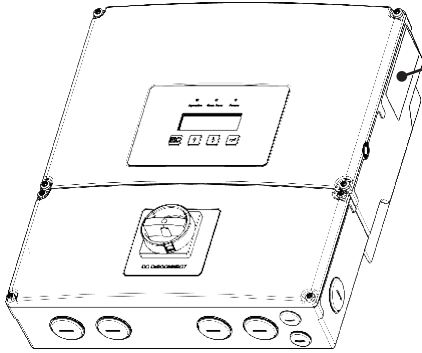

**Figure 7: Lockable DC Disconnect**

DC Disconnect shown with lock in off position. There are three openings on the disconnect where a lockout padlock can be attached as shown above.



## 2.8 Inverter Nameplate and Safety Labels



<b>PVI-3800TL</b>	
DC Max. System Voltage:	600V
DC Operating Voltage Range:	120-280V
DC Full Power MPPT Range:	200-500V
DC Max. Input Current:	25A
AC Nominal Output Voltage:	208V 240V
AC Operating Voltage Range:	180-228V 210-228V
AC Max. Continuous Output Current:	18A 18A
AC Max. Continuous Output Power:	3300W 3900W
AC Nominal Output Frequency:	60Hz
AC Operating Frequency Range:	59.5-60.5 Hz
Output Power Factor:	0.99
UL 1741 CSA 107.1 UL 1505B	LISTED (cUL) Utility Interactive Inverter Type 1 Integrated PV AFCI
This device complies with Part 15 of FCC Rules. Operation is subject to the following two conditions: (1) this device may not cause harmful interference and (2) this device must accept any interference received, including interference that may cause undesired operation.	
Enclosure Type: NEMA 4 Utility-Interactive, Transformerless Inverter Ambient Temp.: -20°C...+70°C, derating >50°C	
<b>PVI-3800TL</b> GCD46011007A Rev.: XX Date Code: YYWW S/N: LLLMMNKKYYWZZZZZ	
 www.soltron.com Made in: China	

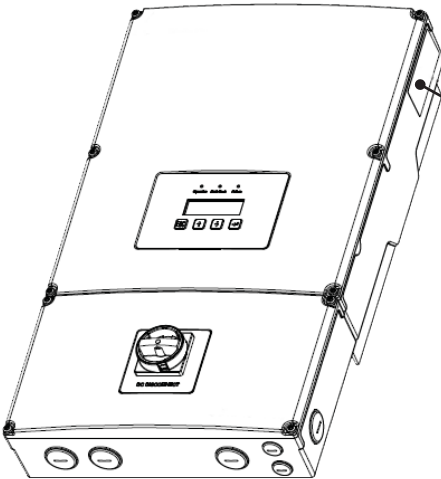

<b>PVI-7600TL</b>	
DC Max. System Voltage:	600V
DC Operating Voltage Range:	120-280V
DC Full Power MPPT Range:	200-500V
DC Max. Input Current:	25A
AC Nominal Output Voltage:	208V 240V
AC Operating Voltage Range:	180-228V 210-228V
AC Max. Continuous Output Current:	31.7A 31.7A
AC Max. Continuous Output Power:	6000W 7000W
AC Nominal Output Frequency:	60Hz
AC Operating Frequency Range:	59.5-60.5 Hz
Output Power Factor:	0.99
UL 1741 CSA 107.1 UL 1505B	LISTED (cUL) Utility Interactive Inverter Type 1 Integrated PV AFCI
This device complies with Part 15 of FCC Rules. Operation is subject to the following two conditions: (1) this device may not cause harmful interference and (2) this device must accept any interference received, including interference that may cause undesired operation.	
Enclosure Type: NEMA 4 Utility-Interactive, Transformerless Inverter Ambient Temp.: -20°C...+70°C, derating >50°C	
<b>PVI-7600TL</b> GCD47011006A Rev.: XX Date Code: YYWW S/N: LLLMMNKKYYWZZZZZ	
 www.soltron.com Made in: China	

**Figure 8: Nameplate Label Location**

The nameplate label is shown in Figure 8.

The inverter serial number can be found on the nameplate label.

**⚡ CAUTION**  
 Risk of electric shock  
 Do not remove or destroy this label.  
 For connecting see manual.

Do not remove cover. No user serviceable parts inside. Refer servicing to qualified service personnel.

Both AC and DC voltage sources are terminated inside this equipment. Disconnect each circuit individually before servicing.

When the photovoltaic array is exposed to light, it supplies DC voltage to the equipment.

Risk of electric shock from energy stored in capacitor. Do not remove cover until 5 minutes after disconnecting all sources of supply.

**WARNING: ELECTRIC SHOCK HAZARD. THE DC CONDUCTORS OF THIS PHOTOVOLTAIC SYSTEM ARE UNGROUNDED AND MAY BE ENERGIZED.**

**WARNING: Electric Shock Hazard.** The DC conductors of this photovoltaic system are normally ungrounded but will become intermittently grounded without indication when the inverter measures the PV array isolation.

Hot surfaces. To reduce the risk of burns, do not touch.

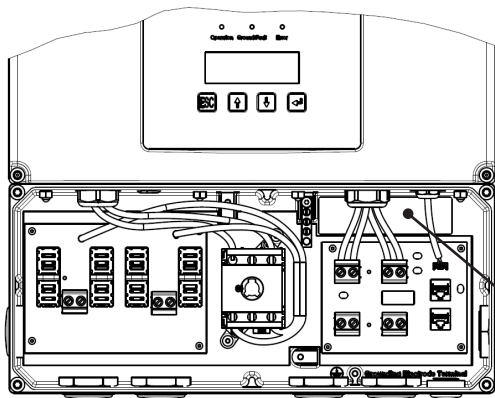
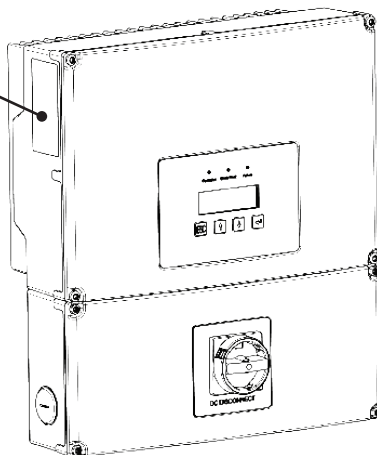

**⚡ WARNING: MORE THAN ONE LIVE CIRCUIT. See diagram in manual**  
**AVERTISSEMENT: PLUSIEURS CIRCUITS SOUS TENSION. Voir le diagramme manuel**

**Figure 9: Location of Caution Labels**

The warning label located in the wiring box enclosure as shown above indicates that there are multiple live DC and AC wires.

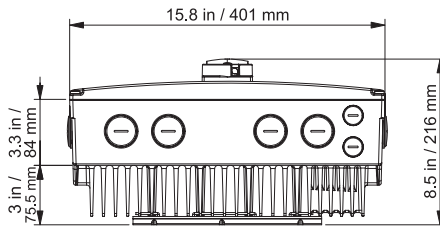
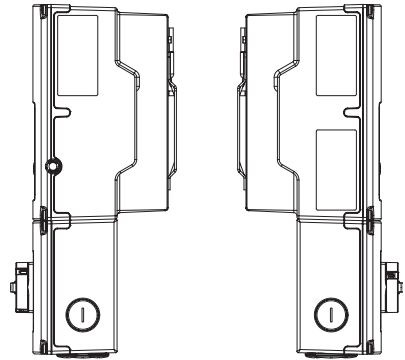
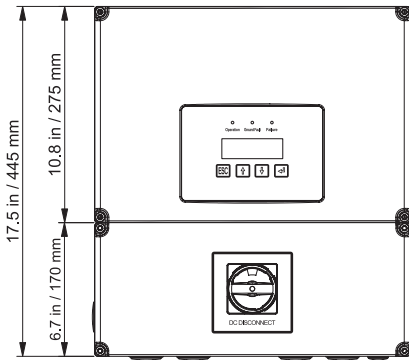

Figure 10: Dimensions of PVI 3800TL inverter

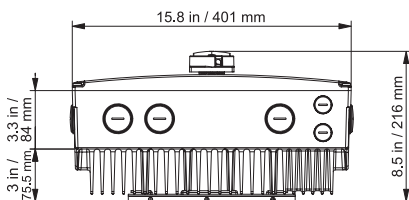
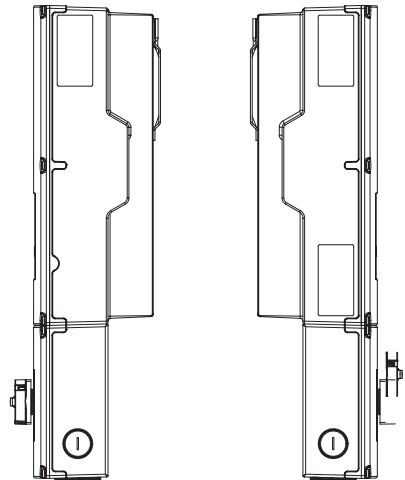
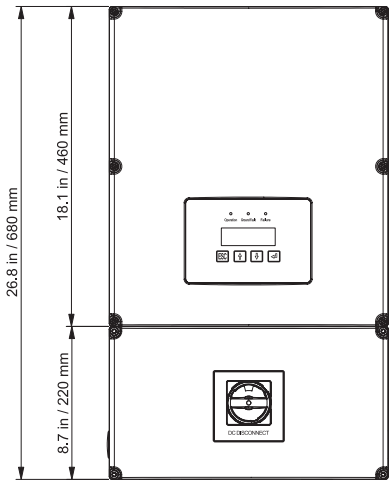
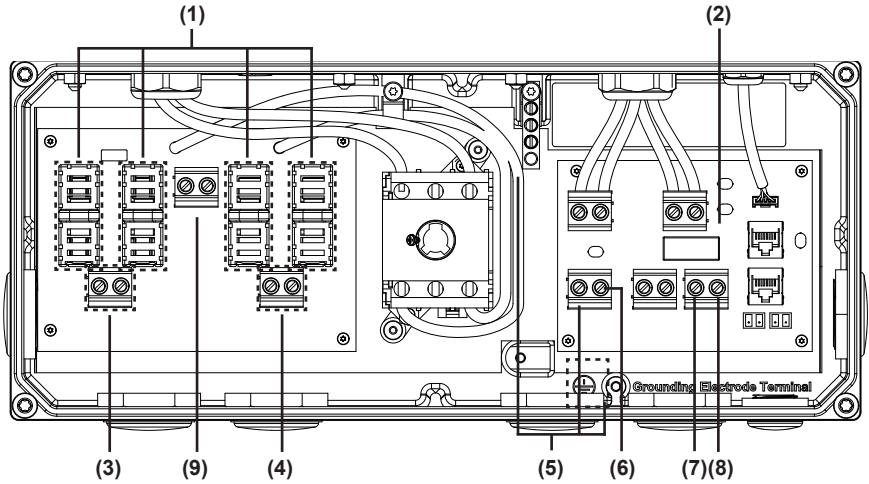
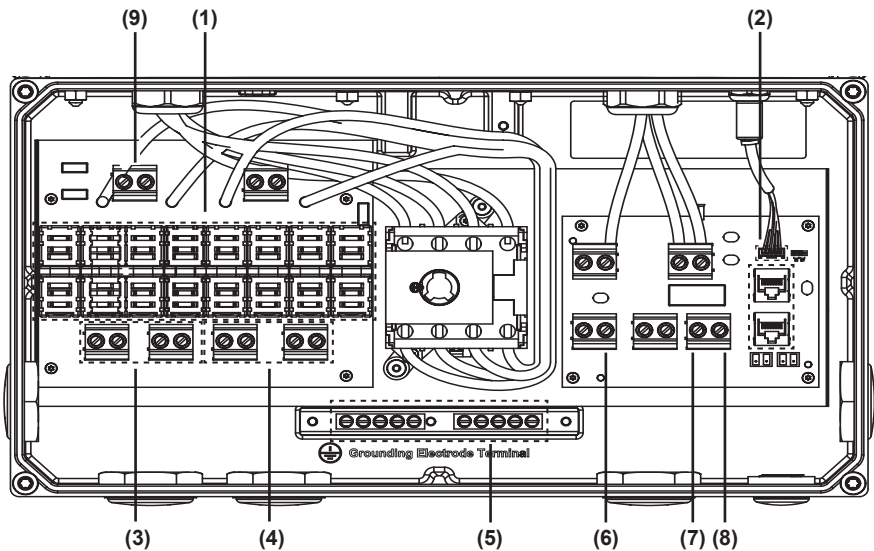

Figure 11: Dimensions of PVI 5200TL, PVI 6600TL and PVI 7600TL inverters



Wiring box of PVI 3800TL solar inverter



Wiring box of PVI 5200TL, PVI 6600TL and PVI 7600TL solar inverters

- |                                |                          |
|--------------------------------|--------------------------|
| (1) String Fuse Holders        | (6) AC side Neutral      |
| (2) RS-485 communication ports | (7) AC side L1           |
| (3) PV Positive Terminals      | (8) AC side L2           |
| (4) PV Negative Terminals      | (9) Fuse bypass terminal |
| (5) Grounding Terminals        |                          |

Figure 12: Wiring box connection options

**Note:** If a source circuits are pre-combined and fused, fuse bypass terminal may be used.

## Required torques for wiring box terminals

Terminals in Figure 12	Wire Size Permitted	Required Torque*
3, 4, 5, 6, 7, 8 (see location and description above)	14 - 6 AWG (2.5 - 16 mm <sup>2</sup> )	10.5 in-lbs (1.2 Nm)

**Table 1: Required torques for wiring box terminals**

### 3 Installation



Read all of these instructions, cautions, and warnings for the Solectria PVI inverter and associated PV array documentation.



Installation and commissioning must be performed by a licensed electrician in accordance with local, state, and National Electrical Code ANSI/NFPA 70 requirements.



The installation and wiring methods used in the installation of this inverter in the U.S. must comply with all US National Electric Code requirements (NEC) and local Authority Having Jurisdiction (AHJ) requirements. In Canada, the installation and wiring methods used must comply with the Canadian Electric Code, parts I and II, and the local AHJ requirements. System grounding when required by the Canadian Electrical Code, Part 1, is the responsibility of the installer.



These servicing instructions are for use by qualified personnel only. To reduce the risk of electric shock, refer all servicing to factory qualified service personnel. No user serviceable are contained inside the inverter.



To reduce the risk of fire, connect only to a circuit provided with dedicated circuit overcurrent protection in accordance with the National Electrical Code, ANSI/NFPA70.



The unit or system is provided with fixed trip limits and shall not be aggregated above 30KW on a single point of common connection.



In order to be able to carry out an accurate energy measurement, a revenue meter measuring kWh may be used between the feed-in point and the inverter.

### 3.1 Visual Inspection

All Solectria PVI inverters are 100% tested, packaged in a heavy duty cardboard shipping carton, and visually inspected before leaving our manufacturing facility. If you receive the inverter in a damaged shipping carton, please reject the shipment and notify the shipping company immediately.

Verify Solectria PVI shipping carton contains:

- a. Correct Solectria PVI inverter model: PVI 3800TL, PVI 5200TL, PVI 6600TL or PVI 7600TL
- b. Mounting bracket
- c. Operation and Installation Manual

Visually inspect the Solectria PVI inverter for any physical damage such as a bent heatsink fin or a dented chassis.

If the inverter appears to be damaged or if the inverter needs to be returned, please contact Solectria customer service.



**No user serviceable parts are contained in the inverter.** Do not attempt to open or repair the inverter. The inverter is factory sealed to maintain its NEMA 4 rating. Breaking the seal will void the inverter warranty.

### 3.2 Installation Location

1. The inverter must be mounted vertically on a flat surface.
2. For clearances around inverter, see Figure 13.
3. Ensure the mounting hardware and structure can support the weight of the inverter.
4. Ensure the mounting hardware meets the appropriate building code.
5. Avoid installation on resonating surfaces (light construction walls etc.).
6. Installation can be indoors or in protected outdoor areas.
7. Avoid direct sun exposure.
8. Ensure inverter ambient temperature is within -13°F to +122°F (-25°C to +50°C) for optimal efficiency of the PV system.
9. Chose a mounting height that allows easy access viewing of the display.
10. Despite having a NEMA 4 / IP65 enclosure with a soiling category III certification, the inverter must not be exposed to heavy soiling.
11. Unused connectors and interfaces must be covered by sealing connectors.

### 3.3 Mounting the Inverter

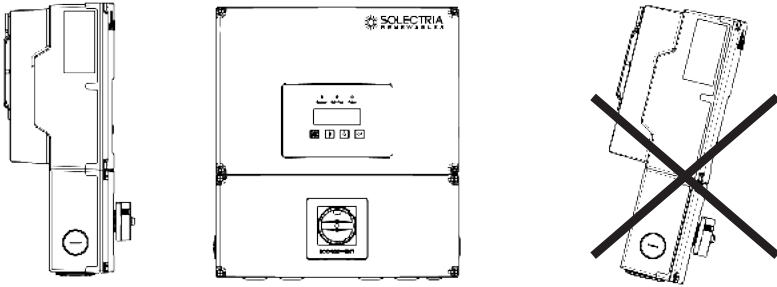

Please make sure the inverter is installed vertically.

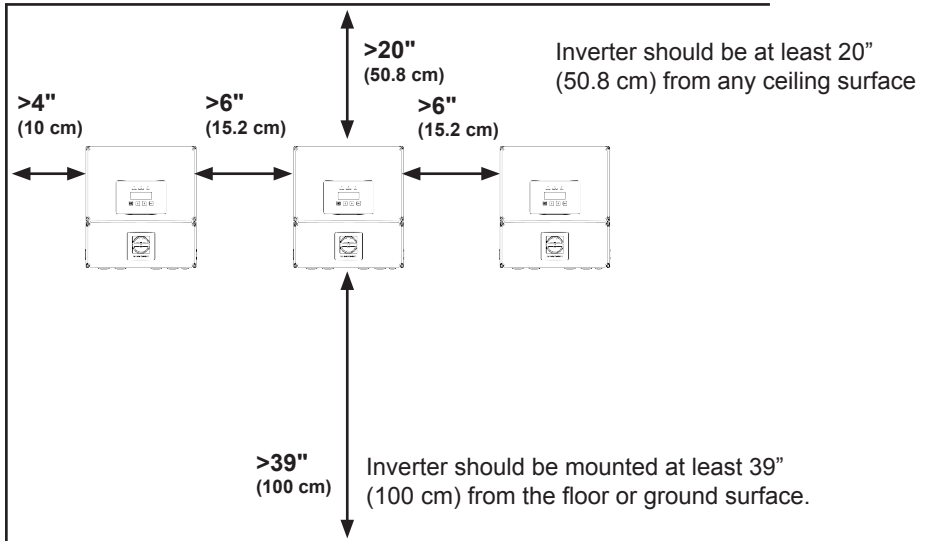

**Figure 13: Inverter clearances**

The National Electric Code may require significantly larger working clearances (see NEC Section 110.26)

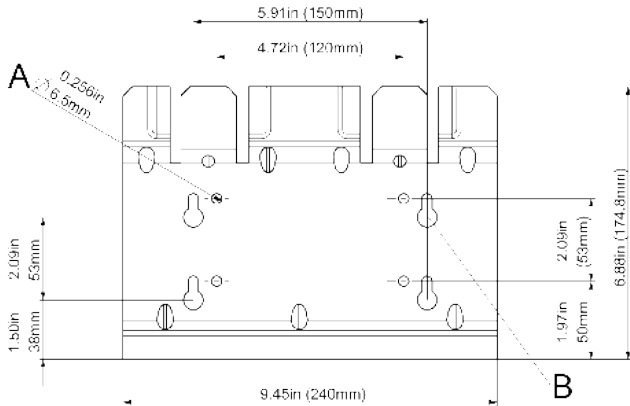

**Figure 14: Dimensional drawing of the mounting plate**

1. Mount the mounting plate to the wall with at least 4 screws and anchors ( $\text{\O} 1/4"$ ). With 4 screws, use either all four 6.5mm mounting holes or all 4 slotted mounting holes. You can use the mounting plate as a template for marking the positions of the boreholes.
2. Tighten the screws firmly to the wall.

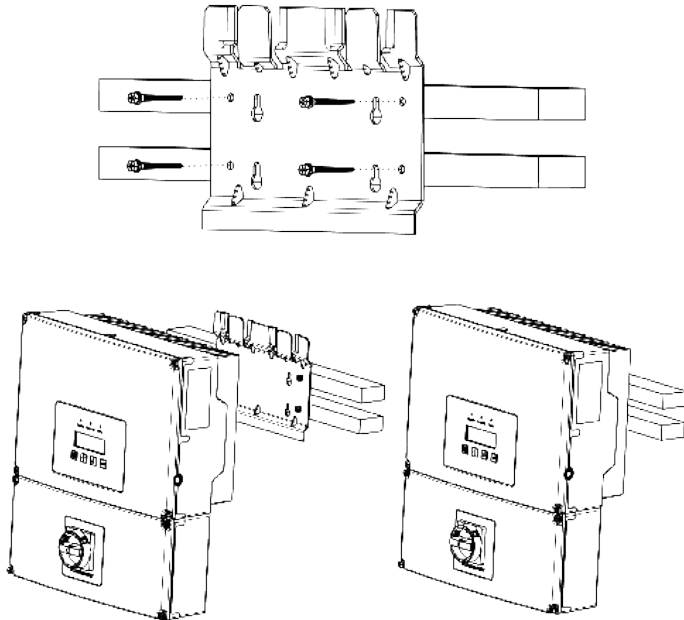

**Figure 15: Installing the mounting bracket and inverter on a wooden stud wall**



1. Using the mounting bracket as a template, mark four screw holes onto the wall. For 16 in. (40.6 cm) on center stud mounting, use the four holes, marked A in Figure 4 on the prior page. Make sure the holes are in the center of each stud before marking the drill location.
2. After marking the screw hole locations, drill the pilot holes for the appropriate screw type that will hold the weight of the inverter in the selected material. 1/4" lag bolts are recommended for mounting on wood framed walls.
3. Align the mounting bracket over the pilot holes and install the mounting hardware flush to mounting surface. Please tighten to the recommended torque necessary to hold the mounting bracket firmly to the wall surface.
4. Because the inverters are heavy, they should be lifted out of the cardboard container by at least two people (PVI 3800TL weighs 43 lbs (19.5 kg) and PVI 5200/6600/7600TL weigh 65 lbs (29.5 kg)).
5. With two people, lift up the inverter and place it carefully onto the mounting bracket.
6. Check that the inverter is seated securely on the wall.

It is recommended to use stainless steel screws, especially if installed outdoors. Be sure to verify shear and pullout strength of anchors or other wall attachments.

### 3.4 Required Torques for PVI Inverters

Part	Description	Required Torque	Tooling
Wiring Box Cover Screws	Torx T30 screws (x4) for attaching the wiring box cover to the wiring box	max. 71 in-lbs (8 Nm)	Torx T30
Wiring Box Interior Nuts	10mm nuts (x4) that secure the wiring box to the inverter stage assembly	max. 71 in-lbs (8 Nm)	10mm wrench

**Table 2: Required Torques for PVI inverters**

## 4 Electrical Connections

### 4.1 General Safety



Read all of the instructions, cautions, and warnings for the Solectria PVI inverter and associated PV array documentation.



Installation and commissioning must be performed by a licensed electrician in accordance with local, state, and National Electrical Code ANSI/NFPA 70 requirements. Use 90°C (194 °F) copper solid or stranded wire only for all DC and AC wiring to the PVI inverter to optimize system efficiency. Size conductors per NEC requirements.



PV solar arrays produce hazardous voltages and currents when exposed to light which can create an electrical shock hazard. Use dark opaque sheets to cover the PV solar array before wiring or connecting cable terminations.



Before connecting the Solectria PVI inverter to the AC distribution grid, approval must be received by the appropriate local utility as required by national and state interconnection regulations, and must be connected only by qualified personnel.



Do not attempt to open or repair the inverter. The inverter is factory sealed to maintain its NEMA 4 / IP65 rating. Breaking the seal will void the inverter warranty.



The AC output circuits are isolated from the enclosure. When required, providing PV system grounding electrode conductor (GEC) is the responsibility of the installer. See NEC 690.41, 690.42, and 690.43.

## 4.2 Utility AC Voltage

The Solectria PVI inverters operate grid-tied to the utility voltage. PVI inverters are software configurable via the user display panel for various 208 V<sub>ac</sub> or 240 V<sub>ac</sub> 60 Hz service configurations as shown in figures 16-22.



**CAUTION!**  
**PRUDENCE!**

The Solectria PVI Inverters must never be connected to a 120 V<sub>ac</sub> utility service. NEC 690.64(b)(1) requires that the inverter be connected to a dedicated circuit with no other outlets or devices connected to the same circuit.

### AC connection voltage and frequency limits:

Voltage range for 208 V nominal, line to line	183 V - 228 V
Voltage range for 240 V nominal, line to line	211 V - 264 V
Frequency Range	59.3 Hz - 60.5 Hz

**Table 3: AC connection voltage and frequency limits**

### Grid configurations allowed:

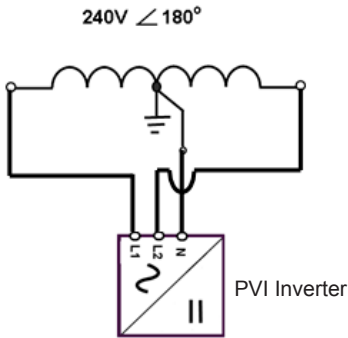

**Figure 16: 240V/120V Split Phase AC Grid**

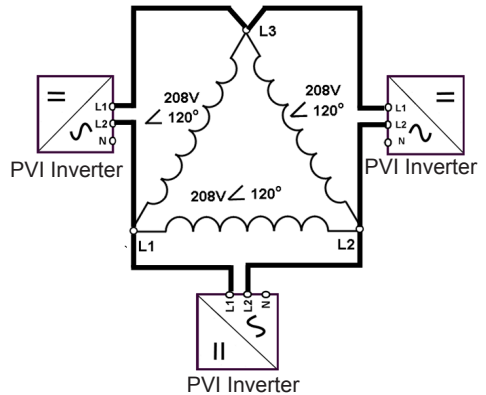

**Figure 17: 208V Delta AC Grid**

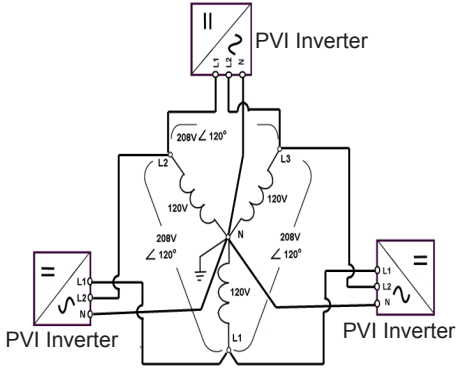

Figure 18: 208V/120V WYE AC Grid

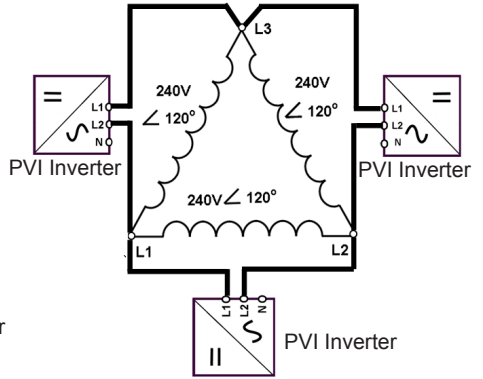

Figure 19: 240V Delta AC Grid

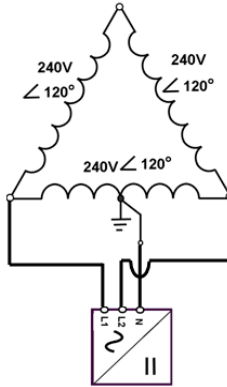

Figure 20: 240V/120V Stinger-Leg AC Grid

**Grid Configurations NOT Allowed:**

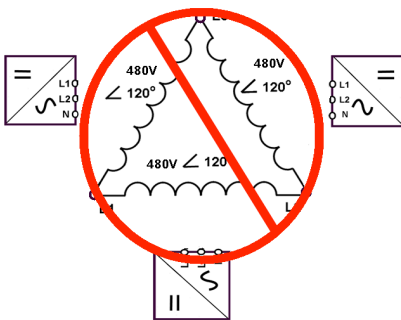

Figure 21: 480V Delta AC Grid

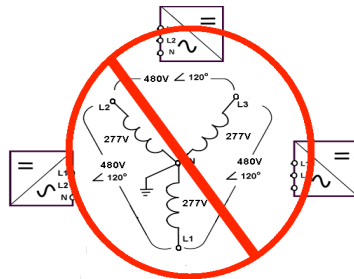

Figure 22: 480V/277V WYE AC Grid

### 4.3 AC Circuit Breaker Requirements

A dedicated over current protection device in the building circuit panel is required for each Solectria PVI inverter. There must be a circuit breaker or fuse to protect each AC phase, L1 and L2. The over current protection device should be able to handle the rated maximum output voltage and current of the inverter. Please refer to the table below to determine the appropriate circuit breaker size to avoid potential fire hazards. The National Electrical Code (NEC), ANSI/NFPA 70 or applicable local electrical codes must be followed when determining maximum branch-circuit over-current protection requirements.

Inverter Model	Maximum AC Branch Protection
PVI 3800TL	2-pole, 20 A 208/240 V <sub>ac</sub>
PVI 5200TL	2-pole, 40 A 208/240 V <sub>ac</sub>
PVI 6600TL	2-pole, 40 A 208/240 V <sub>ac</sub>
PVI 7600TL	2-pole, 40 A 208/240 V <sub>ac</sub>

### 4.4 Grounding Terminals

Each inverter comes with grounding terminals for use with DC Equipment Grounding Conductors (EGC) and AC EGC. The grounding bars and the AC grounding screw terminal are bonded together internal to the inverter. See NEC 690.47 for more information regarding requirements for the grounding electrode system.

### 4.5 Lightning and Surge Protection

Solectria PVI inverters are designed and certified to meet stringent UL 1741 / IEEE 1547 and ANSI/ IEEE 62.41/62.42 AC lightning and surge requirements; however, every PV installation is unique, thus additional external UL/NEC AC and DC surge protection and solid grounding practice are recommended. The inverter comes equipped with Type II AC and DC Varistors.

#### Surge Suppression

This inverter includes surge suppression. The capabilities of the included surge suppression capabilities are as follows:

STANDARD WAVEFORM PEAK VALUES		
Surge Category	Ring Wave	Combination Wave
B	6 kV / 0.50 kA	6 kV / 3 kA

- “Standard 1.2/50  $\mu$ s - 8/20  $\mu$ s Combination Wave”
- “Standard 0.5  $\mu$ s - 100 kHz Ring Wave”

### 4.6 Multiple Inverters

Multiple Solectria PVI inverters are permitted at a common location if all applicable NEC, state, local building codes and local utility commissioning guidelines are met. However, each inverter must have its own dedicated AC overcurrent protection device and a separate PV array.

#### 4.7 PV String Considerations

There are a large number of PV module string combinations that will offer optimal performance from either the PVI 3800TL, PVI 5200TL, PVI 6600TL and PVI 7600TL inverters due to their wide MPP DC voltage range (200 V – 500 V). Please use Solectria's online string sizing tool at <http://solectria.com/support/string-sizing-tool/>.



If string sizing is done manually, follow the temperature multiplication factors given in NEC 690.7 table or the PV module manufacturer specified temperature coefficient to ensure PV string voltage is less than  $< 600 V_{dc}$  at minimum design temperature.



System wiring voltage losses should be no greater than 2 percent on DC and AC side for optimal system efficiency and performance.

#### Maximum DC/AC Oversizing is 1.4X

Inverter Model	Maximum DC Power Connected
PVI 3800TL	5,320W
PVI 5200TL	7,280W
PVI 6600TL	9,240W
PVI 7600TL	10,640W

The PVI 5200TL, PVI 6600TL and PVI 7600TL inverters have 2 separate MPPT zones. When designing with two separate roof slopes or a shaded area in the array this allows for the opportunity to isolate into one of the zones. To expand even further, the design provides options for the two zones to handle mismatch. Each of the zones can process up to 67% of the total rated power (even after oversizing). See the chart below:

Inverter Model	Maximum DC Power Connected	MPPT1 / MPPT2 67% / 33%	Total Continuous Power
PVI 5200TL	7,280W	4877.6W / 2402.4W	5200W
PVI 6600TL	9,240W	6190.8W / 3049.2W	6600W
PVI 7600TL	10,640W	7128.8W / 3511.2W	7600W

**Note 1:** The inverter total power output cannot be higher than the inverter rating. This mismatch capability is just to further enhance design flexibility.

**Note 2:** In the chart above the extreme case of 67% / 33% mismatch is shown. Any combination that is less than 67% for one zone and greater than 33% for the other would also work.

## 4.8 Inverter Connections

### 4.8.1 General Information



Installation and commissioning must be performed by a licensed electrician in accordance with local, state, and National Electrical Code ANSI/NFPA 70 requirements.



Input and output circuits of this unit are isolated from the enclosure. System grounding must be done in accordance with the National Electrical Code (NEC). Compliance is the responsibility of the installer.



Establish electrically safe work conditions by ensuring there are no live voltages present on PV input and AC output circuits and that all dedicated DC and AC disconnects/breakers are locked out and tagged. Verify that the inverter's DC disconnect and AC disconnect are in the "OFF" position, before inverter installation.



PV solar arrays produce hazardous voltages and currents when exposed to light which can create an electrical shock hazard. Use dark opaque sheets to cover the PV solar array before wiring or connecting cable terminations.



Before any electrical wiring can be connected to the inverter, the inverter must be permanently mounted.



Use solid or stranded copper conductors only for AC and DC connections. 6 AWG (16 mm<sup>2</sup>) is the maximum allowed wire size.



Inverter warranty is VOID if the DC input voltage exceeds the inverter's 600 V<sub>dc</sub> maximum.

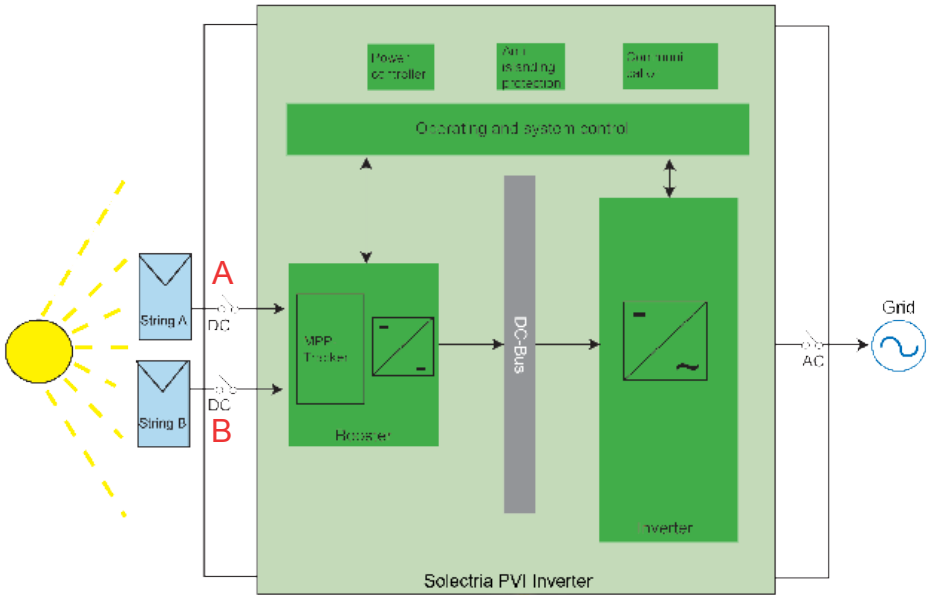

Figure 23: PVI 3800TL Inverter electrical diagram

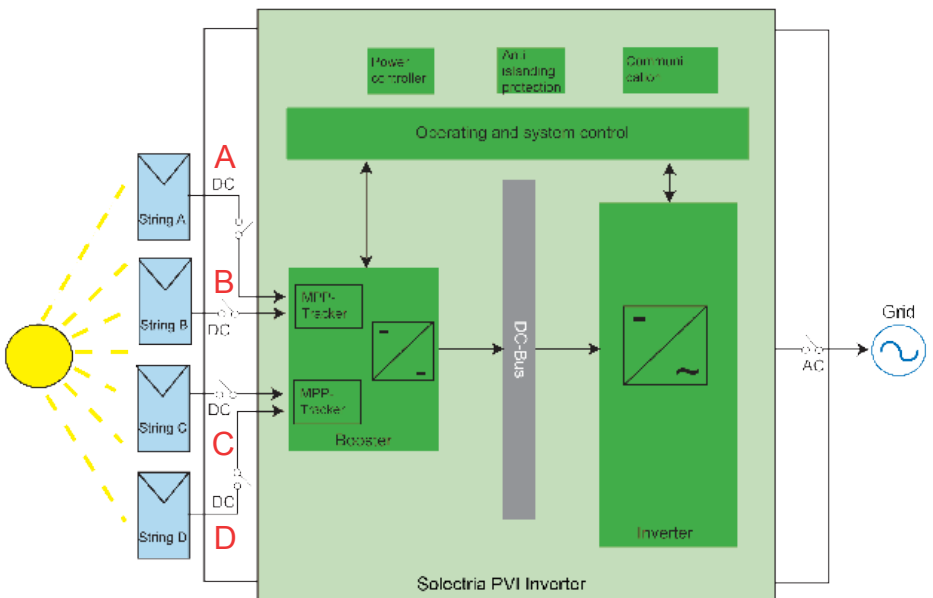

Figure 24: PVI 5200TL, PVI 6600TL and PVI 7600TL Inverter electrical diagram





POWER IS FED FROM MORE THAN ONE SOURCE, MORE THAN ONE LIVE CIRCUIT EXISTS. Please see diagram above.

#### 4.8.2 Opening the Wiring Box Cover



Ensure no live voltages are present on PV input and AC output circuits, and verify that the DC disconnect is in the “OFF” position, and that are dedicated AC and DC disconnects/breakers locked out before inverter installation.



PV solar arrays produce hazardous voltages and currents when exposed to light which can create an electrical shock hazard. Use dark opaque sheets to cover the PV solar array before wiring or connecting cable terminations.

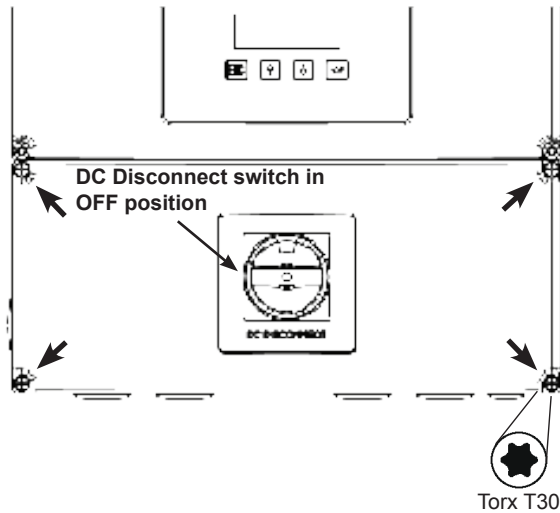

**Figure 25: Removing the wiring box cover**

1. Place DC Disconnect switch in “OFF” position. Please note the cover cannot be removed when the DC Disconnect switch is in the “ON” position.
2. Remove the 4 cover screws indicated above.
3. Lift the cover upward and place it off to the side.

### 4.8.3 Wiring Box Conduit Openings

Conduit openings are provided for 1 inch and ½ inch conduit fittings. If the conduit fitting used is between 1 inch and ½ inch (2.54 cm and 1.27 cm), an appropriate conduit reducer should be used.

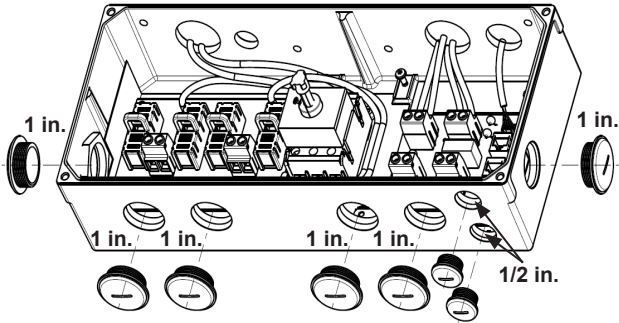
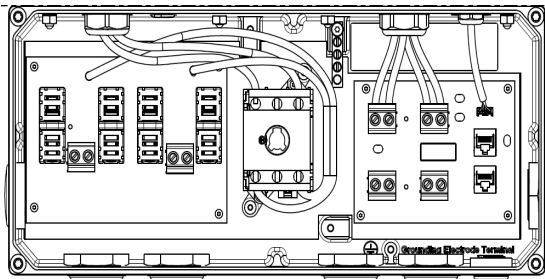

Figure 26: Wiring box conduit opening locations



Do not enlarge the wiring compartment conduit openings as the wiring box enclosure will be damaged which will void the inverter warranty.



The conduit plugs are removed by placing a flat head screwdriver in the slot on the conduit plug face and turning it while gripping the nut on the inside of the enclosure. Unscrew the nut from the conduit plug and slip the conduit plug out of the conduit opening.

Figure 27: Wiring box conduit plug removal (illustration showing the removal of a conduit plug)



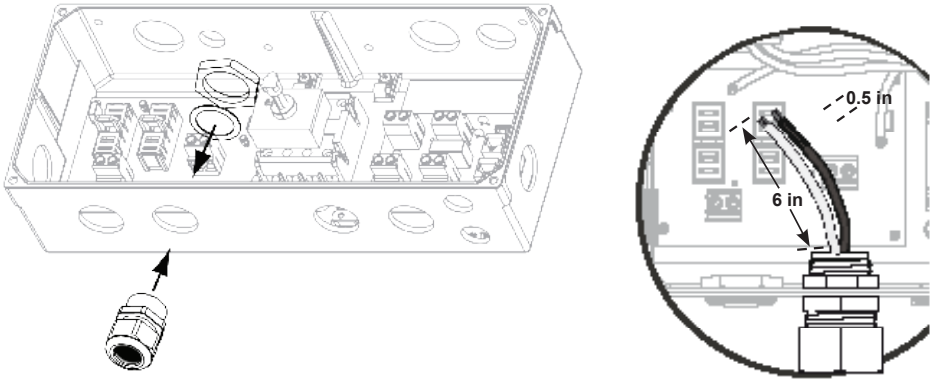

**Figure 28: Conduit installation and wiring routing**

Conduit fittings need to be water tight with either a NEMA 4, 4X, 6, or 6X rating.

Once conduit and fittings are installed, route wiring through the conduit and fitting and allow a 6 inch strain relief service loop within the wiring box compartment.

#### 4.8.4 PV Array String Input Connections



To ensure maximum protection against hazardous contact voltages while assembling photovoltaic installations, both the positive and the negative leads must be strictly isolated electrically from the ground. All string fuses must be removed from the wiring box.



- Risk of electric shock and fire. Use only with PV modules that are listed for use with system voltage of 600V.
- Electric shock hazard. The DC conductors of this photovoltaic system are ungrounded and may be energized.
- Electric shock hazard. The DC conductors of this photovoltaic system are ungrounded but will become temporarily grounded without indication when the inverter measures the PV array isolation.



- Verify all DC source circuit voltages and polarities with a volt meter because damage to the inverter could result if incorrect DC input voltages or polarity is connected to it. After verification of correct voltage and polarity, DC fuses can be installed.



The PV Array positive or negative leads must not be connected to ground.



All screw terminals accept solid or stranded copper 14 – 6AWG wire only. A torque wrench with a flat head screw driver is recommended for tightening screw terminals to a 10.5 in-lbs. (1.2 Nm) torque.

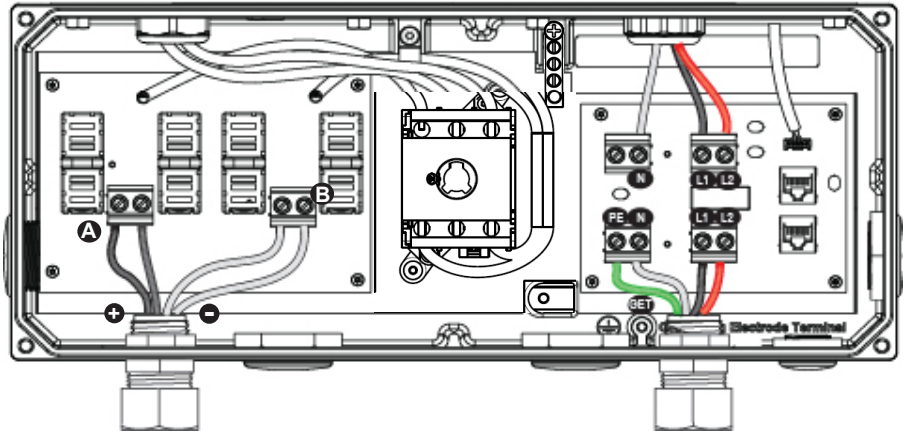

- A** PV Positive Terminals
- B** PV Negative Terminals

**PVI 3800TL wiring box diagram**

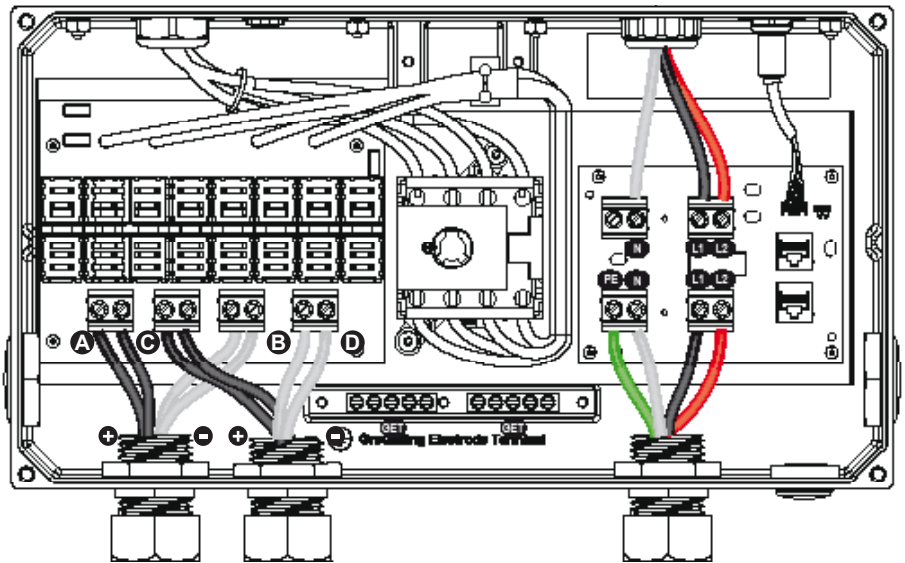

- A** PV1\_Positive Terminals
- B** PV1\_Negative Terminals
- C** PV2\_Positive Terminals
- D** PV2\_Negative Terminals

**PVI 5200TL/PVI 6600TL/PVI 7600TL wiring box diagram**

**Figure 29: PVI Wiring box - PV input connections**

1. Verify that the exposed wires are at least 6 inches in length to provide adequate strain relief and wire end strip length. Secure the conduit into both fittings then tighten conduit fittings to manufacturer's recommended torque.
2. Connect the positive lead from each PV array string to 1 of the PV Positive Terminals (A) in the wiring box compartment. Using a torque wrench, tighten the screw terminal to 10.5 in-lbs (1.2 Nm) of torque.
3. Connect the negative lead from each PV array string to 1 of the PV Negative Terminals (B) in the wiring box compartment using a torque wrench, tighten the screw terminal to 10.5 in-lbs (1.2 Nm) of torque.

#### 4.8.5 Selecting PV String Fuse(s)

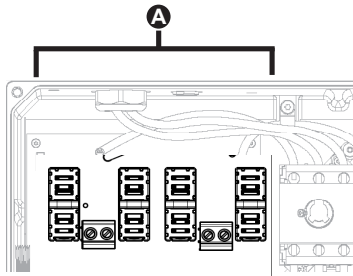

**A** = 4 String Fuse Holders

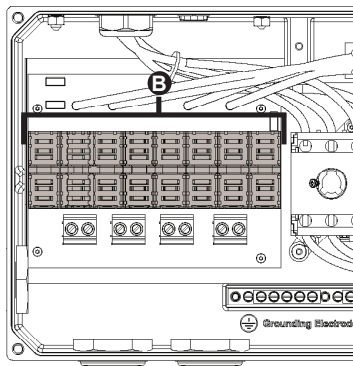

**B** = 8 String Fuse Holders

**Figure 30: Fuse string locations**

#### 4.8.5.1 PV String Fuse Information and Calculating String Fuse Size

The PVI 3800TL inverter is shipped with 4 x 15 A 600V<sub>dc</sub> Littelfuse KLKD 15 string fuses. PVI 5200TL, PVI 6600TL, and PVI 7600TL inverters are shipped with 8 X 15 A 600V<sub>dc</sub> Littelfuse KLKD 15 string fuses. The provided string fuses may or may not be appropriate for your particular installation. Proper sizing of overcurrent protection is based on the maximum short circuit current I<sub>sc</sub> (module) and calculated in accordance with NEC Article 690 requirements.



The maximum acceptable string fuse for the string combiner is 20A PV (KLKD 20) fuse. Use of larger fuses will void the warranty.



The string fuse rating should never exceed the Maximum Series Fuse Requirement provided by the module manufacturer. This value is typically listed on the module label.

##### 4.8.5.1.1 Calculating the Minimum String Fuse per NEC Article 690

The minimum string fuse size is calculated by multiplying the module I<sub>sc</sub> x 1.56.

For example: If you are using modules that have an I<sub>sc</sub> = 6.25 A, you would calculate the minimum string fuse size as follows:

$$\text{String Fuse (minimum)} = 6.25 \text{ A} \times 1.56 = 9.75 \text{ A}$$

A partial listing of the Littelfuse KLKD Fuses is as shown.

Part Number	Amperage	Type
KLK D 008. ....	8 A .....	PV Fuse
KLK D 009. ....	9 A .....	PV Fuse
KLK D 010. ....	10 A .....	PV Fuse
KLK D 012. ....	12 A .....	PV Fuse
KLK D 015. ....	15 A .....	PV Fuse
KLK D 020. ....	20 A .....	PV Fuse

It is worth noting that for this example we calculated the minimum series fuse rating. However, it may be appropriate to use the supplied 15 A fuses as long as they do not exceed the maximum series fuse rating (provided by the module manufacturer) or the overcurrent protection requirements of your PV source wires. Please reference the appropriate NEC Article(s) for further discussion regarding proper sizing of overcurrent protection.

#### 4.8.5.1.2 PV Fuse Properties

Other fuse manufacturers may have compatible fuse types. The generic properties are:

- Type: PV Fuse
- Fast-acting
- Dimensions: 1 1/2" in length x 13/32" fuse diameter
- Interrupt Rating:  $\geq 10 \text{ kA @ } 600 \text{ V}_{\text{dc}}$
- UL and CSA approval of the fuse is mandatory

#### 4.8.5.2 String fuse replacement



String fuses shall only be replaced by a qualified professional. Ensure no live voltages are present on PV input and AC output circuits, and verify that the DC disconnect, AC disconnect, and dedicated AC branch circuit breaker are in the "OFF" position, before attempting to replace DC fuses. With a DC amperage clamp meter, ensure that there is no current flowing through the fuse to be replaced.



PV solar arrays produce hazardous voltages and currents when exposed to light which can create an electrical shock hazard. Using dark opaque sheets, cover the PV solar array before tampering or reinserting PV string fuses

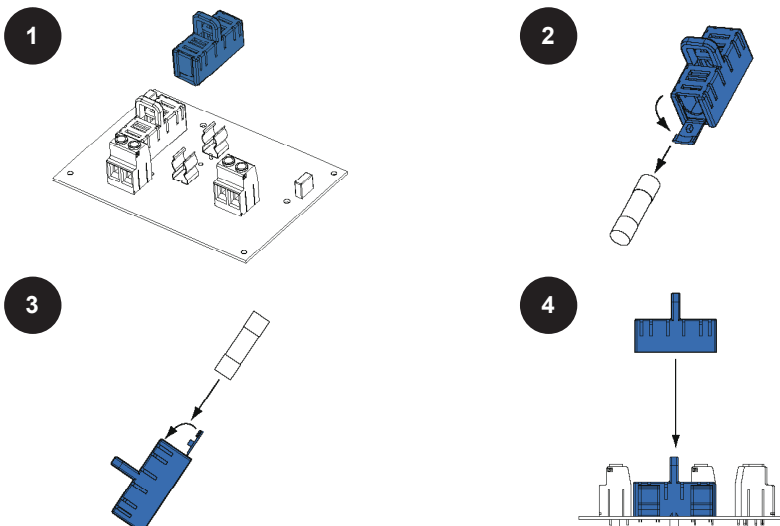

Figure 31: String fuse replacement procedure



Note: Refer to Figure 31 for String Fuse Locations.

1. Verify the absence of DC current in each string with a DC clamp meter.
2. Gripping only the plastic tab on top of the fuse extractor, pull straight upwards without touching the fuse's metal end caps or fuse-holder clips on printed circuit board.
3. Away from open wiring box compartment, open the fuse extractor door and tilt fuse extractor downward with a hand underneath to catch fuse as it slides out of fuse extractor.
4. Next place the replacement fuse into fuse extractor and tilt upward to keep fuse from dropping out. Close the fuse extractor door.
5. With fuse / fuse extractor parallel to empty fuse position, lower fuse extractor while aligning fuse caps with open fuse clips. Then push downward until the fuse snaps into the clips.

Follow the same procedure for replacing the other string fuses.

#### 4.8.6 Inverter AC Output Wire Connections



- Read all of the instructions, cautions, and warnings for the Solectria PVI Inverter and associated PV array documentation.
- Installation and commissioning must be performed by licensed electrician in accordance with local, state, and National Electrical Code ANSI/NFPA 70 requirements.
- Ensure no live voltages are present on PV input and AC output circuits, and verify that the DC disconnect, AC disconnect, are in the “OFF” position, before inverter installation.
- Verify that the dedicated 2-pole 240 V<sub>ac</sub> / 208 V<sub>ac</sub> circuit breaker in the building electrical service panel is turned-off and locked out.



All screw terminals accept solid or stranded copper 14 – 6 AWG wire only. A torque wrench is recommended for tightening screw terminals to a 10.5 in-lbs (1.2 Nm) torque.

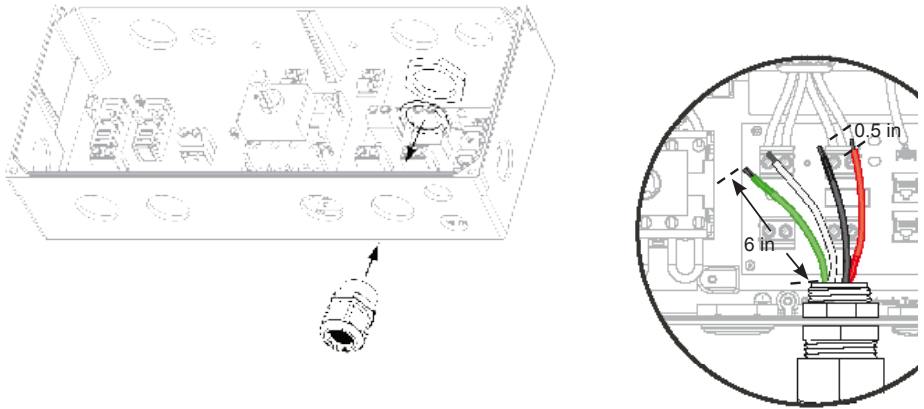

**Figure 32: Conduit installation and AC wiring routing**

Conduit fittings need to be water tight with either a NEMA 4, 4X, 6, or 6X rating.

Once conduit and fittings are installed, route wiring through the conduit and fitting and allowing a 6 inch strain relief loop within the wiring box compartment.

Determine the AC voltage loss in the AC wires for a given wire cross section and wire length. The following pages contain diagrams for each PVI inverter model to help determine the best wire size for your particular installation. Solectria recommends that you select a wire size and length to ensure a maximum voltage. Please note that the diagrams only show approximate voltage loss and more precise voltage loss should be calculated by a licensed electrician in accordance with local, state, and National Electrical Code ANSI/NFPA 70 requirements. The conductor size shall not be smaller than the 75°C wire size based on the ampacities given in table 310.16 of the NEC, ANSI/NFPA 70 and an additional derating factor of 125% as indicated by UL1741.

### PVI 3800TL

Percentage of voltage loss with 208 VAC and 240 VAC service. The load used in the calculation is the max continuous AC current of the inverter.

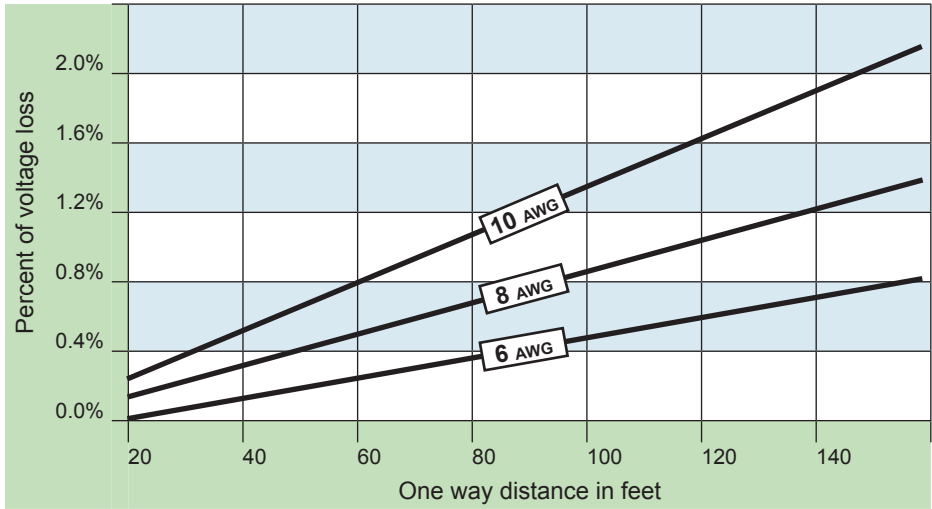

Figure 33: PVI 3800TL-AC voltage loss with different wire sizes and lengths

### PVI 5200TL, PVI 6600TL and PVI 7600TL

Percentage of voltage loss with 208 VAC and 240 VAC service. The load used in the calculation is the max continuous AC current of the inverter.

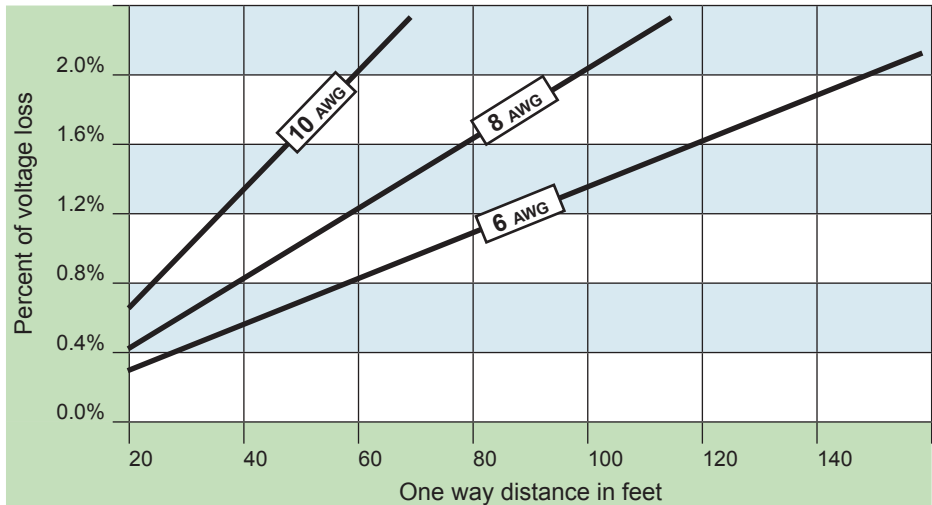
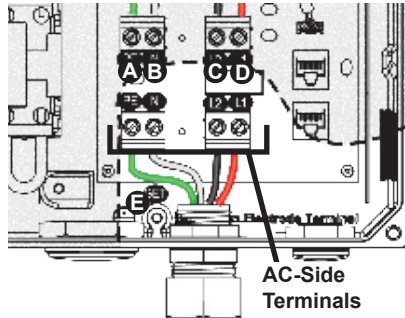

Figure 34: PVI 75200TL, PVI 6600TL and PVI 7600TL AC voltage loss with different wire sizes and lengths



- Ⓐ PE Terminal (AC System Ground)
- Ⓑ N Terminal
- Ⓒ L2 Terminal
- Ⓓ L1 Terminal
- Ⓔ GET (Grounding Electrode Terminal)

**Figure 35: Wiring box AC assembly – terminal labeling**



Stranded copper wire should be checked for all strands inside the terminal opening.



An additional external AC disconnect may be required by your local AHJ. Please check local regulations to determine if the AC disconnect is required for your installation.

1. Mount the external AC disconnect (if required by local AHJ) near the inverter.
2. Install conduit fitting and conduit into the wiring box compartment from AC disconnect or utility service panel.
3. Route AC wiring through conduit and verify that the exposed wires are at least 6 inches in length to provide adequate strain relief and wire end strip length. Secure the conduit into both fittings then tighten conduit fittings to manufacturer's recommended torque.
4. Terminate inverter's AC output wires inside the AC disconnect or junction box.
  - Connect the AC system GND wire to the PE screw terminal (A) and using a 3/16" (4mm) flat blade cabinet screw driver tighten the screw terminal to 10.5 in-lbs (1.2 Nm) of torque.
  - Connect the Neutral wire to the "N" screw terminal (B), and using a torque wrench, tighten the screw terminal to 10.5 in-lbs (1.2 Nm) of torque.

- Connect L1 wire to the “L1” terminal (D), and using a torque wrench, tighten the screw terminal to 10.5 in-lbs (1.2 Nm) of torque.
- Connect L2 wire to the “L2” terminal (C), and using a torque wrench, tighten the screw terminal to 10.5 in-lbs (1.2 Nm) of torque.



Stranded copper wire should be checked for all strands inside the terminal opening.



If a neutral wire connection is required for the connection grid to make sure the neutral wire is securely connected to the neutral terminal. Loose neutral wire connection will result in incorrect grid voltage detection.

#### 4.8.7 Inverter RS-485 Communication Connections



Read all of these instructions, cautions, and warnings for the Solectria PVI inverter and associated PV array documentation first.

#### Interface Connection RS-485

The Solectria PVI inverters offer an RS-485 communication interface which can address up to 16 daisy chained inverters. For optimal performance, the last inverter in the chain must always have the termination jumper placed in the “on” position.

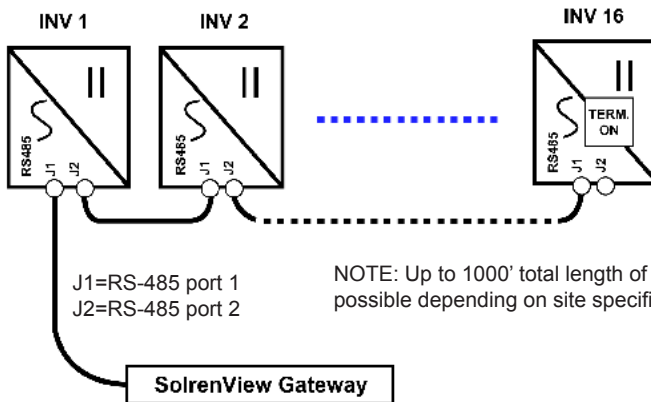
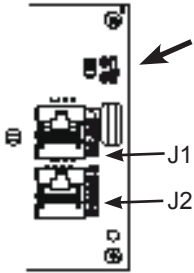

Figure 36: Inverter RS-485 system diagram



The Termination Jumper is shown in the diagram on the left. To enable termination place the jumper over the two upper pins next to the “on” label on the board. To disable termination place the jumper in the off position on the lower two pins.

**Figure 37: RS-485 Termination Jumper**

**RS-485 Connector Pin-Out**

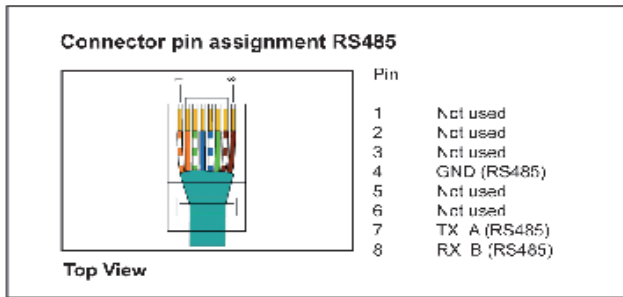

**Figure 38: RS-485 connector pin-out**

<b>RS-485 Data Format</b>	
Baud Rate	Programmable, 2400/4800/9600/19200/38400, default = 19200
Data Bit	8
Stop Bit	1
Parity	N/A

Contact Solectria for available 485 cables for daisy-chaining multiple inverters or connecting them to a SolrenView data monitoring logger.

**4.8.8 SolrenView External Monitoring**

The PVI 3800TL, 5200TL, 6600TL and 7600TL inverters include an option for a SolrenView external gateway. This device can be used for the purpose of web-based monitoring and data logging.

From the inverter a user can configure and monitor the inverter using a human-machine interface (HMI). This HMI consists of the LCD display and four buttons.

The backside of SolrenView gateway provides connectivity to the data monitoring system. Solectria’s SolrenView web-based data monitoring system can be interfaced using Ethernet over twisted pair.

The inverter is not capable of powering the SolrenView data logger. A separate 12V wall power supply is shipped with each data logger.

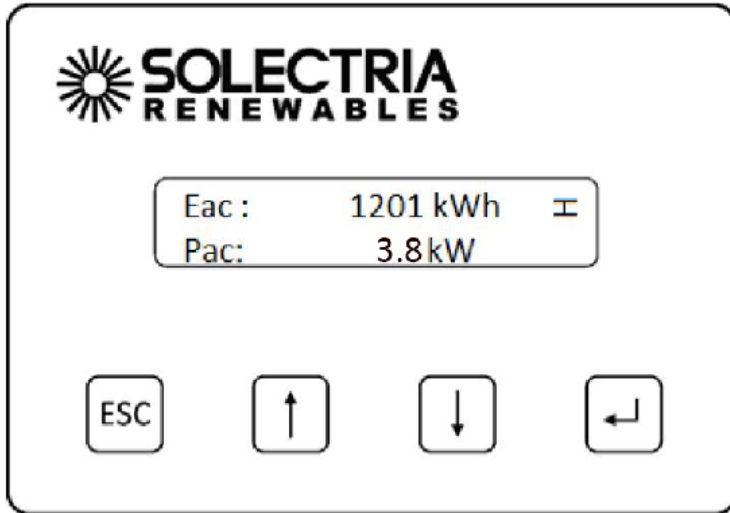

Figure 39: SolrenView Gateway HMI

## 5 Commissioning the PV system



Read all of these instructions, cautions, and warnings for the Solectria PVI inverter and associated PV array documentation.



Installation and commissioning must be performed by a licensed electrician in accordance with local, state, and National Electrical Code ANSI/NFPA 70 requirements.



Verify that the dedicated 2-pole  $240 V_{ac}$  /  $208 V_{ac}$  circuit breaker in the building electrical service panel is turned-off and locked out.



Wearing full PPE, with the disconnect in the “OFF” position, verify the PV input polarity once more simply by carefully using a  $600 V_{dc}$  rated digital volt meter and probing the positive (+) and negative (-) PV array connections.

## 5.1 Status LEDs

No.	Label	Designation	Color
(A)	<b>POWER</b>	Power	Green
(B)	<b>GROUND FAULT</b>	Ground Fault	Red
(C)	<b>ERROR</b>	Error	Yellow

Information on the LED messages is provided in section 8. "Diagnosis and maintenance", p. 61.

## 5.2 Display and Keypad

### 5.2.1 Components

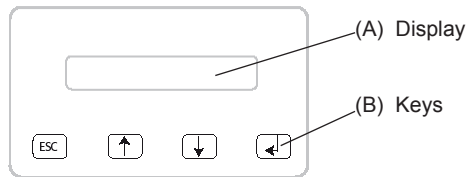

### 5.2.2 Display Layout

```
      Format
-----
->Date:   DD.MM.YYYY
Time:    12h
```

The display has 4 rows of 20 characters each.





The first row contains the name of the currently displayed menu.

The second to fourth rows show the menu elements.

A small arrow in the third row shows the currently selected menu item.



### 5.2.3 Keypad

Symbol	Use
	<ul style="list-style-type: none"><li>• Exit the current menu</li><li>• Cancel the setting of a value</li></ul>
	<ul style="list-style-type: none"><li>• Move upwards in a menu</li><li>• Set a value (increase the value)</li></ul>
	<ul style="list-style-type: none"><li>• Move downwards in a menu</li><li>• Set a value (decrease the value)</li></ul>
	<ul style="list-style-type: none"><li>• Select a menu entry</li><li>• Open a configurable value for editing</li><li>• Finish editing (adopt the set value)</li></ul>

### 5.2.4 General Menu Structure

The menus have up to three levels:

[Main menu]

...

**400 Production info**

**410 Current data**

**411 Current overview**

**412 Current data AC**

...

**420 Day statistics**

**430 Week statistics**

...

**500 User settings**

Most menu names consist of a three-digit number and a menu title.

See Section 12.3 Overview of menu structure” for an overview of the complete menu structure.

## 5.2.5 Menu Tree

### Menu Tree

Install settings  
Options  
Production info  
Diagnostic&Alarm  
Inverter info  
Standard menu

### Install Settings

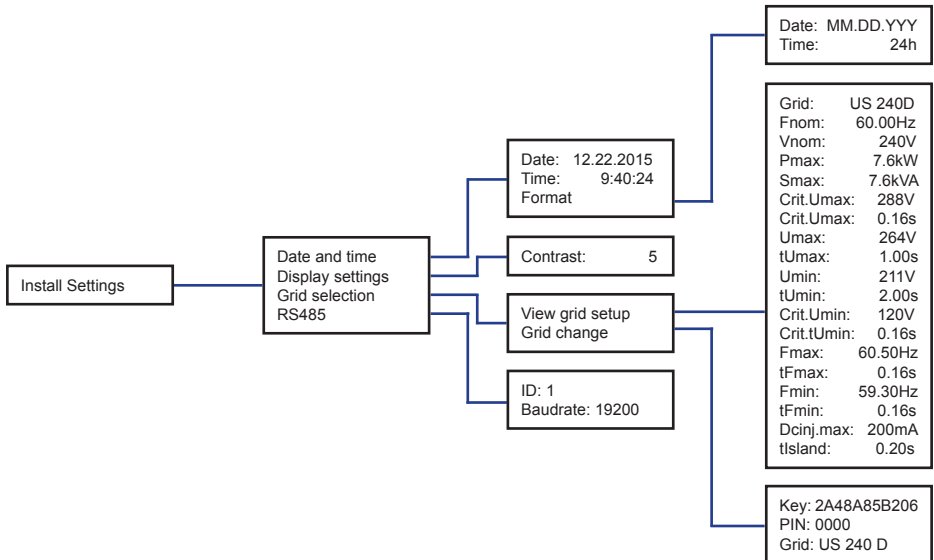

### Options

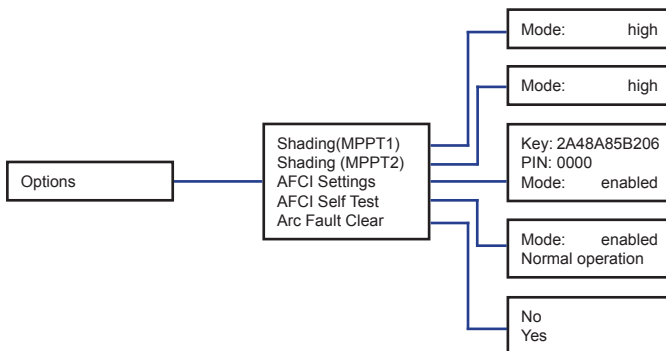

Production Info

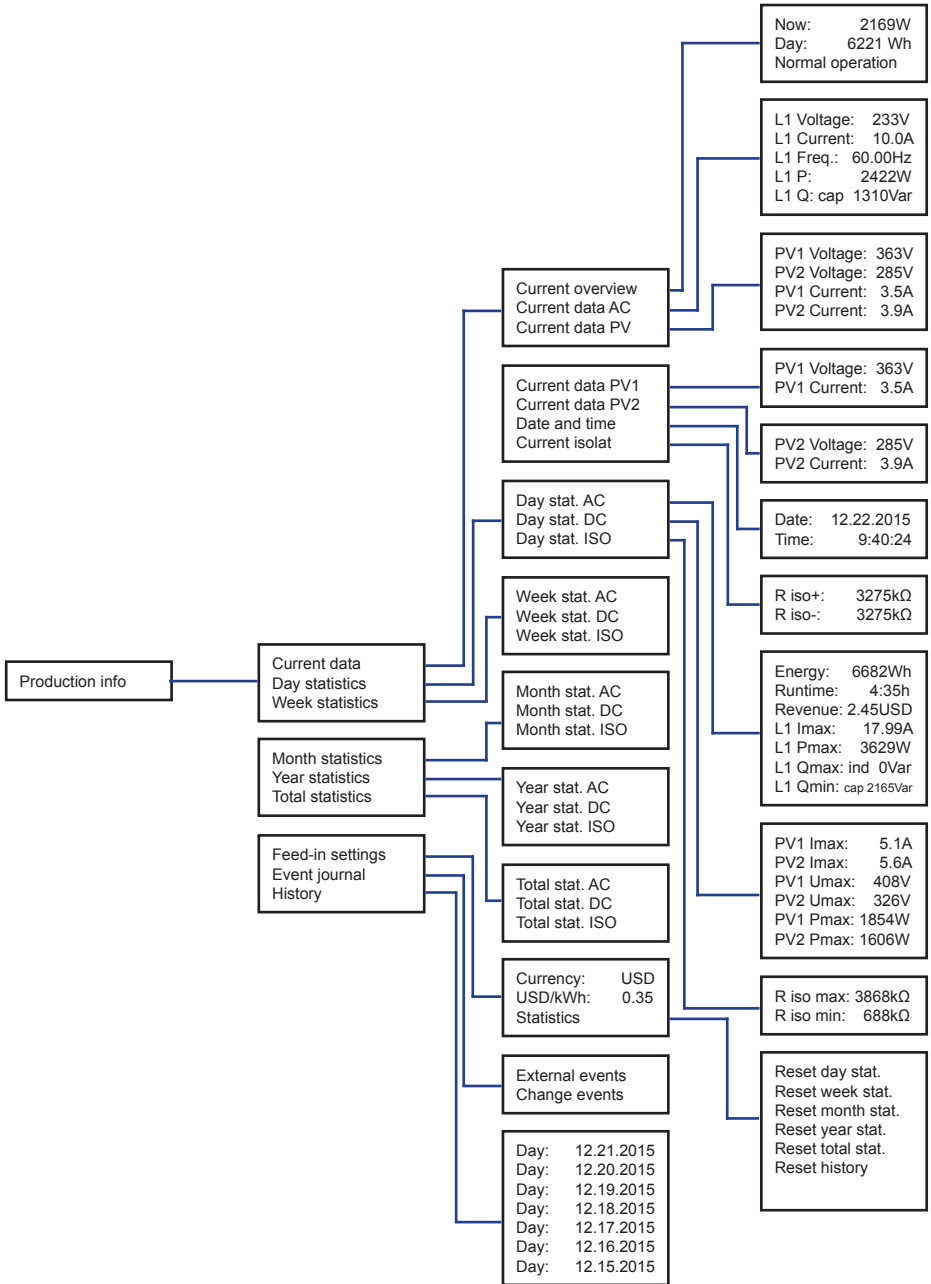

## Diagnostic&Alarm

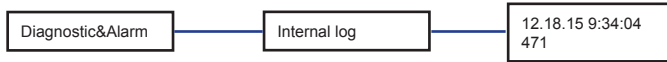

## Inverter info

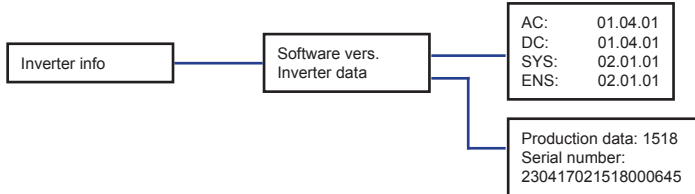

## Standard menu



### 5.3 Inverter Turn-On Procedure

1. Refer to Section 5 for commissioning process that needs to be completed before the inverter can begin feeding power to the grid.
2. Turn on the DC disconnect (put in closed position).
3. Check for inverter initialization; all 3 LED indicators are illuminated.
4. Unlock and turn on the dedicated 2-pole 240 V<sub>ac</sub> / 208 V<sub>ac</sub> circuit breaker in the building electrical service panel.
5. Turn on the AC disconnect.

### 5.4 Inverter Turn-Off Procedure

1. Turn off the AC disconnect.
2. Turn off the dedicated 2-pole 240 V<sub>ac</sub> / 208 V<sub>ac</sub> circuit breaker in the building electrical service panel and lock it out.
3. Turn off the DC disconnect.

### 5.5 Standard Initial Commissioning

#### 5.5.1 Brief Overview of the Commissioning Steps

- Select the grid voltage configuration
- Set up the RS-485 communication

### 5.5.2 Detailed Description of the Commissioning Steps

1. Check all connections and cables for damage and correct seating. Correct the installation if necessary.
2. Switch on the DC disconnect→ The startup process of the inverter begins.

After the startup process and the automatic self-test, the initial commissioning procedure of the inverter starts and the **Installation** menu is displayed.

3. Select a grid.

```
Grid Selection
-----
->Grid:      US 208 D
Continue
```

Grids available for standard commissioning	
Display text	Description
US 208 D	US 208 DELTA 3 PHASE SYSTEM
US 208 WYE	US 208V/120V WYE 3 PHASE SYSTEM
US 240 D	US 240 DELTA 3 PHASE SYSTEM
US 240 STING	US 240/120 STINGER LEG 3 PHASE SYSTEM
US 240 SPLIT	US 240/120 SPLIT PHASE SYSTEM

4. Select **Continue** and press the  key.

```
Grid Selection
Grid:      US 208 D
->Continue
-----
```

→ The **RS-485** menu is displayed

5. Set the RS-485 ID and the baud rate.

```
RS485
-----
->ID:      1
Baud Rate: 19200
```

Configurable Parameters		
Display text	Designation	Description
ID	RS-485 ID	1 .. 255
Baud rate	Baud rate	2400   4800   9600   19200   38400, the standard is 19200



Connecting multiple inverters via RS-485.

– If multiple inverters are to be connected via RS-485, select a different ID for each inverter. This ID will also be used later to identify each inverter when loading settings or transferring data.

6. Select **Continue** and press the  key.

```

RS485
Baud Rate: 19200
->Continue
-----
-> The last menu is displayed

```

7. Press the  key to finish commissioning.

```

ENTER
to confirm
ESC
to reselection

```

Commissioning is now finished.

## 5.6 Setting Values

You can set parameters in several menus. The   keys are used to change parameter values.

The  key increases the value of the parameter.















The  key decreases the value of the parameter.



















The  key can be used to cancel the setting, and the original value is then displayed once more.

Pressing the  key causes the new parameter value to be adopted.

The example on the next page illustrates the procedure for changing the value of a parameter. This procedure is the same for all configurable parameters.

*Example: Setting the date*

Keys	Action	Result
 	1. Press the   keys in the main menu to select the <b>Install settings</b> menu.	PVI ## G4 ----- ->Install settings Options
	2. ..Press the  key to open the <b>100 Install settings</b> (installation settings) menu.	100 Install settings ----- ->Date and time Display settings
	3. ..Press the  key to open the <b>110 Date and time</b> menu.	110 Date and time Format ->Date: 18/06/2013 Time: 13:10:20pm
 	4. Use the   keys to select <b>Date</b> menu item.	110 Date and time Format ->Date: 18/06/2013 Time: 13:10:20pm
	5. ..Press the  key to begin making the setting.  → The digits for the first value (in this case the month) flash.	110 Date and time Format ->Date: 18/ <b>06</b> /2013 Time: 13:10:20pm

Keys	Action	Result
 	6. Use the   keys to set the month.	110 Date and time Format ->Date: 18/07/2013 Time: 13:10:20pm
	7. Press the  key to adopt the new value.  → The digits for the second value (in this case the day) flash.	110 Date and time Format ->Date: 18/07/2013 Time: 13:10:20pm
 	8. Use the   keys to set the day.	110 Date and time Format ->Date: 15/07/2013 Time: 13:10:20pm
	9. ...Press the  key to adopt the new value..  → The digits for the last value (in this case the year) flash.	110 Date and time Format ->Date: 15/07/2013 Time: 13:10:20pm
 	10. Use the   keys to set the year.	110 Date and time Format ->Date: 15/07/2014 Time: 13:10:20pm
	11. ...Press the  key to adopt the new value..  √ The value is adopted and the editing mode is exited.	110 Date and time Format ->Date: 15/07/2014 Time: 13:10:20pm



## 6 Production Information



All energy production information is provided for informative purposes only. An accurate external revenue grade meter provided by the wiring company is the authoritative source of information for invoicing.

### 6.1 Overview

The 400 Production info menu contains current data and statistics. The information is write-protected and cannot be edited.

– Select the **Production info** menu item in the main menu.

→ The **400 Production info** menu is displayed.

```
400 Production Info
-----
->Current Data
    Day Statistics
```

#### Structure of the 400 Production info menu

Sub-menu	Content	Description
410 Current data	Current data for power, AC, PV, insulation	“6.2 Current data”
420 Day statistics	Statistics for AC, PV and ISO	“6.3 Other statistics”
430 Week statistics		
440 Month statistics		
450 Year statistics		
460 Total statistics		
470 Feed-in settings	Settings for currency and revenue per kWh	“7.3 Grid feed-in settings”
480 Event journal	List of operating state messages	“8. Diagnosis and maintenance”
490 History	Statistics for the last seven days in which the inverter was in operation.	“6.3 Other statistics”

## 6.2 Current Data

The current data values are provided in the menu **410 Current data**.

### Access

- Access the menu by navigating to **Main menu > Production info > Current data**.
- The **410 Current data** menu is displayed.

```
410 Current data
-----
->Current overview
Current data AC
```

### Structure

Sub-menu	Contents and example display
411 Current overview	<p>Current power and energy generation for the current day. Current operating state (see “8. Diagnosis and maintenance”)</p> <pre>411 Current Overview Now:                _W Day:                _Wh Normal operation</pre> <p>If there <u>are</u> messages, the list of messages can be opened by pressing the  key. For a detailed description, see chapter “8. Diagnosis and maintenance”</p>
412 Current data AC	<p>Displays for: voltage, frequency, current, active power P, reactive power Q</p> <pre>412 Current data AC L1 Voltage:        _V L1 Current:        _._A L1 Freq.:          _._Hz</pre>
416 Current data PV	<p>Data for: voltage, current</p> <pre>416 Current data PV PV1 Voltage:      ---V PV1 Current:      -.-A</pre>

Sub-menu	Contents and example display
41A Date and time	Shows the current date and time.  Use the <b>110 Date and time</b> menu to set the values, see “7.2.1 Date and time”.  <pre>41A Date and time Date:  18/06/2013 Time:  10:20:30</pre>
41B Current isolation	Data for: maximum and minimum insulation resistances  <pre>41B Current isolat. R iso+:      _kΩ R iso-:      _kΩ</pre>

### 6.3 Other Statistics

Menu
420 Day statistics
430 Week statistics
440 Month statistics
450 Year statistics
460 Total statistics
490 History

#### Example display

```
420 Day statistics
Day stat. AC
->Day stat. PV
Day stat. ISO
```

The statistics for day, week, month, year and total production time all offer the same type of data.

The **490 History** menu shows the statistics for the last seven days over which the inverter was in operation.

```
490 History
Day:  10.10.12
->Day:  10.10.12
Day:  10.10.12
```

## Structure

Sub-menu	Contents
421 Day stat. AC	Statistics for: total energy, runtime, revenue
431 Week stat. AC	Information on configuring the revenue settings is provided in "7.3 Grid feed-in settings".
441 Month stat. AC	
451 Year stat. AC	
461 Total stat. AC	421 Day stat. AC Energy:        ---Wh Runtime:        :--h Revenue:        --.--USD
	Displays for: Δf Minimum/maximum frequency I <sub>max</sub> Maximum current ΔU Minimum/maximum voltage P <sub>max</sub> Maximum active power Q <sub>max</sub> Maximum reactive power Q <sub>min</sub> Minimum reactive power
	<pre> 421 Day stat. AC L1 Δf: ---/--.--Hz L1 I<sub>max</sub>:  --.--A L1 ΔU:    ---/---V           </pre>
422 Day stat. DC	Displays for:
432 Week stat. DC	P <sub>max</sub> Maximum power
442 Month stat. DC	I <sub>max</sub> Maximum current
452 Year stat. DC	U <sub>max</sub> Maximum voltage
462 Total stat. DC	<pre> 422 Day stat. DC PV1 I<sub>max</sub>:    _._A PV1 U<sub>max</sub>:        _V PV1 P<sub>max</sub>:        _W           </pre>

Sub-menu	Contents
423 Day stat. ISO	Statistics for: maximum/minimum insulation resistances
433 Week stat. ISO	
443 Month stat. ISO	
453 Year stat. ISO	
463 Total stat. ISO	
	Pmax Maximum power Imax Maximum current
	423 Day stat. ISO
	R ISO max: ----kΩ
	R ISO min: ----kΩ

491 ... 497 Day ... Statistics for the last 7 days in which the inverter was in operation.

The statistics contain the same information as the menus **421**, **422** and **423**.

```
491 Day 18.06.2013
Energy: ---Wh
Runtime: -:-h
Revenue: --.---USD
```

## 6.4 Deleting Statistics



### Description

All statistics can be deleted (except for **410 Current data**). The procedure is always the same.

1. Navigate to **Production info > Feed-in settings > statistics**.

→ The **471 statistics** menu is displayed.

```
471 Statistics
->Reset day stat.
Reset week stat.
Reset month stat.
```

2. Use the   keys to select the statistic you wish to delete (e.g., **Reset day stat.**) and press the  key.

→ A confirmation query is displayed.

3. Select the option **Yes** and press the  key to delete the statistic.

```
Reset day stat.  
-----  
No  
->Yes
```

→ A confirmation message is displayed.

```
Reset day stat.  
  
Successful  
Press Enter
```

The statistic for the day is deleted.

## 7 Settings

### 7.1 Overview

This chapter describes how to edit the configurable settings.

- Installation settings (Section 7.2 “Installation settings”)
- Grid feed-in settings (Section 7.3 “Grid feed-in settings”)
- Options settings (Section 7.4 “Options settings”)
- Standard menu (Section 7.5 “Standard menu”)

Information on operating the display is provided in Section 5.2 “Display and keypad”.

### 7.2 Installation Settings

#### Configurable settings

- Date, time
- Date and time format
- Contrast
- Grid configuration selection
- RS-485 settings

## 7.2.1 Date and Time

### Description

<b>Menu</b>	<b>110 Date and time</b>
Menu access	Main menu > Install settings > Date and time
Example display	<pre>110 Date and time Format -&gt;Date: 18/06/2013 Time: 13:10:20pm</pre>

### Configurable Parameters

Display text	Designation	Description
Date	Date	Feedly configurable according to the selected date format.
Time	Time	Feedly configurable according to the selected time format.

## 7.2.2 Date and Time Formats

### Description

<b>Menu</b>	<b>111 Format</b>
Menu access	Main menu > Install settings > Date and time > Format
Example display	<pre>111 Format -&gt;Date: DD/MM/YYYY Time: 13:10:20pm</pre>

### Configurable Parameters

Display text	Designation	Description
Date	Date format	DD.MM.YYYY DD/MM/YYYY DD-MM-YYYY
Time		12h   24h

### 7.2.3 Contrast

#### Description

Menu	120 Display settings
Menu access	Main menu > Install settings > Display settings
Example display	120 Display settings ----- Contrast: 10

#### Configurable Parameters

Display text	Designation	Description
Contrast	Display Contrast	5...10

### 7.2.4 Grid Selection



If the selected grid is changed, a completely new commissioning process must be started, see Section 5. Commissioning the PV system”.

Always first contact the Solectria Support Team **before** changing the selected grid!



You always require a PIN in order to enter the grid selection mode. You require a new PIN each time you wish to select a new grid configuration. You obtain a key for the PIN from the Solectria Support Team on request.





You must provide a key in order to receive a PIN. You will find the key in the menu 132 Grid change.

1. To display the key, navigate to **Main menu > Install settings > Grid selection> Grid change**.

```
132 Grid change
Grid:      US 208 D
Key:      #####
PIN: ____ Confirm
```



The key consists of 11 numbers and letters.

2. The Solectria Support Team will provide you with the four digit PIN.
3. When you have received the PIN, navigate to the menu **132 Grid change** and press the  key.  
→ The first digit of the PIN flashes.
4. Use the   keys to set the first digit and press the  key to proceed to the next digit.  
→ After entering the full PIN, the word **Confirm** flashes.

```
132 Grid change
Grid:      US 208 D
Key:      #####
PIN: 1234  Confirm
```

5. Press the  key to confirm the entered PIN.  
→ The **Installation** menu is displayed.

```
Installation
-----
->Language:  English
continue
```

6. Start the commissioning of the inverter, see “5. Commissioning the PV system”.

## 7.2.5 RS-485

### Description

Menu	111 Format
Menu access	Main menu > Install settings > RS-485
Example display	<pre>140 RS485 ----- -&gt;ID:      1 Baud rate: 19200</pre>

## Configurable Parameters

Display text	Designation	Description
ID	RS-485 ID	1...255
Baud rate	Baud rate	2400   4800   9600   19200   38400, the standard is 19200



### Connecting multiple inverters via RS-485.

- ▶ Select a different ID for each inverter.
- ▶ A 220 ohm termination resistor must be connected to the last inverter in the series (see “4.8.7 Inverter RS-485 Communication Connections”).



NOTICE: An optional full-featured inverter direct data acquisition and logging gateway and web-based service, SolrenView, is available from Solectria (<http://www.solrenview.com>). The gateway allows the inverter to deliver information to the SolrenView server through the facility's internet service.

## 7.3 Grid Feed-In Settings

### Description

<b>Menu</b>	<b>470 Feed-in settings</b>
Menu access	<b>Main menu &gt; Production info&gt; Feed-in settings</b>
Example display	<pre>470 Feed-in settings -&gt;Currency:      USD   USD / kWh:     0.28</pre>

### Configurable Parameters

Display text	Designation	Description
Currency	Currency	No pre-defined values.
USD / kWh	USD/kWh	No pre-defined values. The amount (USD) per kWh is required for the revenue calculation.

## 7.4 Options Settings

### Configurable settings

- Shading
- AFCI setting
- AFCI self test
- Arc fault clear

#### 7.4.1 Shading

##### Description

The “Shading” option is an extended MPP tracker. When the option is switched on, the MPP tracker performs an additional search at regular intervals.

The MPP tracker then searches for the maximum power over a wider voltage range.

This option should be switched on if shadows regularly pass slowly over the PV modules in the course of a day. These types of moving shadows can be caused by chimneys or trees, for example. Do NOT use this option for normal fast-moving shadows, e.g., from passing clouds.

The option is set depending on the size of the shading.

Menu	210 Shading
Menu access	Main menu > Options > Shading
Example display	<pre>210 Shading ----- -&gt;Mode:      disabled -----</pre>

##### Configurable Parameters

Display text	Designation	Description
Mode	Mode	Disabled
		Extended MPP tracking is disabled
		High
		High shading, time cycle: 0.5 hours
		Medium
		Medium shading, time cycle: 2 hours
Low	Low	Low
		Low shading, time cycle: 4.5 hours

## 7.4.2 AFCI Setting



If the AFCI setting is changed, a completely new commissioning process will need to be started, see “5. Commissioning the PV system”.



A PIN is required each time you wish to change the AFCI setting. You can obtain a PIN from the Solectria Customer Service Team upon request.

You must provide a key in order to receive a PIN. You will find the key in the menu 230 AFCI Setting.



1. To display the key, navigate to **Main menu > Options > AFCI Setting**.

```
230 AFCI Setting
Key:      #####
->PIN:    ____
Mode:     enabled
```

The key consists of 11 numbers and/or letters.

2. The Solectria Customer Service Team will provide you with the four digit PIN.
3. When you have received the PIN, navigate to the menu **230 AFCI Setting** and press the  button.

→ The first digit of the PIN flashes.

4. Use the   buttons to set the first digit and press the  button to proceed to the next digit.

→ After entering the full PIN, the word **Confirm** will flash.

```
230 AFCI Setting
Key:      #####
->PIN:    1234->Confirm
Mode:     enabled
```

5. Press the  button to confirm the entered PIN.

→ The **AFCI Setting** menu is displayed. You can enable or disable the arc detection function through it.

```
AFCI Setting
-----
->Mode:     enabled
Continue
```

6. Start the commissioning of the solar power inverter, see “5. Commissioning the PV system”.

### 7.4.3 AFCI Self Test

#### Description

The “AFCI Self Test” is a manual test function. When “enabled,” a self test of the arc detection function will be carried out. If the internal circuit is OK, the inverter will show “AFCI Test Pass!” on the display and shut down once the test passes. The inverter will start up again after the self test.

1. To display the arc self test, navigate to **Main menu > Options > AFCI Self Test**.

```
240 AFCI Self Test
-----
->Mode:      disabled
Normal Operation
```

2. To enable the AFCI self test, change the mode from “disabled” to “enabled”. When the test passes, the mode will change back to “disabled”. The inverter will be shut down.

```
240 AFCI Self Test
-----
->Mode:      disabled
AFCI Test Pass!
```

3. The inverter will restart. The operation mode will show “normal operation” again.

### 7.4.4 Arc Fault Clear

#### Description

When an arc fault occurs, the inverter will shut down and the “Arc Fault Detected!” message will be displayed. The inverter will remain off until the arc fault is cleared manually.

1. Check the operation mode of the inverter, navigate to **Main menu > Production info > Current data > Current overview**. If an arc fault occurs “Arc Fault Detected!” will be displayed.

```
411 Current overview
Now:      _W
Day:      _Wh
Arc Fault Detected!
```

2. To clear the arc fault status, navigate to **Main menu > Options > Clear Arc Fault**

```
Clear Arc Fault
-----
->No
Yes
```

3. Select "Yes" and press the  button.

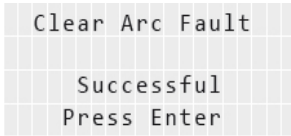

4. Press the  button. The display page will go back. The inverter will start up.

## 7.5 Standard Menu





### Description

A standard menu can be defined, which is automatically displayed when the display keys are not used for a certain period of time. When the standard menu is displayed, pressing the  key displays the main menu.

The standard menu is set to 411 Current data at the factory. This menu shows the current data and current operating messages.

The number must be a valid menu number.

See "12.3 Overview of menu structure" for an overview of all available menu numbers.

1. Press the  key to enter the menu number.
  - The first digit flashes.
2. Enter the first digit of the menu number using the   keys.
  - You can only set menu numbers that actually exist. The name of the associated menu is displayed in the fourth display row.
3. Once you have set the first digit, press the  key.
  - The second digit flashes.
4. Enter the second and third digit in the same manner.
5. Press the  key.
  - The menu corresponding to the entered menu number is displayed.

Menu	800 Standard
Menu access	Main menu > Standard
Example display	<pre> 800 Standard menu ----- -&gt;Menu number:   411   411 Current overview           </pre>

## Configurable Parameters

Display text	Designation	Description
Menu number	Menu number	Any valid menu number.

## 8 Diagnosis and Maintenance

### 8.1 Operating States

#### 8.1.1 Types of Operating States

Operating State	Associated Influencing Factors	Grid Feed-In
Normal operation	No factors are present that limit the energy production results.	Yes
Limited operation	Non-critical factors that can affect the energy production but which are not equipment or system failures (e.g., self-test).	Limited
Warning	External events or internal failures are present that affect the production results.	Yes
Failure		No
Insulation or grounding failure	A problem exists with the insulation	No

See section 8.1.2 for a description of the influencing factors.

Note: When in failure mode, the inverter will not produce power.

#### 8.1.2 Factors Influencing the Operating State

Different influencing factors are assigned to the individual operating states. These influencing factors are divided into the following categories.

##### Non-critical factors

Non-critical factors are (for example) the self-test or a DC voltage that is too low due to bad weather. Non-critical factors are therefore not failures.

##### Events

Events are usually caused outside the inverter. Events are divided into **external events** (e.g., voltage or frequency errors) and **parameter changes** occurring via the keys or the RS-485 interface.

##### Internal failures

Internal failures are caused from within the inverter and must be corrected with help of the Solectria Support Team.

## Insulation and grounding failures

Insulation and grounding failures are logged and displayed when this failure occurs. When an insulation or grounding failure is indicated, the failure has to be corrected by the installer before the inverter will restore power production.

### 8.1.3 Display of the Current Operating State

The actual operating state is indicated via LEDs. A short message is also shown in the fourth line of the **411 Current overview** menu.

```
411 Current Overview
Now:           _lw
Day:           _wh
Normal operation
```

The **411 Current overview menu** is automatically displayed when a new message arrives.

LED status		Message category	Display text in menu 411
Green	<ON>	Normal operation	Normal operation
Red	<OFF>		
Yellow	<OFF>		
Green	<ON>	Limited operation	e.g. Self-test
Red	<OFF>		
Yellow	<OFF>		
Green	<ON>	General warning messages	For external events: External events
Red	<OFF>		For internal failures: Warning ### (3-digit number)
Yellow	<Flash>		
Green	<OFF>	General failure messages	For external events: External events
Red	<OFF>		For internal failures: Failure ### (3-digit number)
Yellow	<ON>		
Green	<OFF>	Insulation or grounding failure	Insulation
Red	<ON>		
Yellow	<OFF>		

The software defines which events trigger a warning and which events trigger a failure.



## 8.2 Event Log

### 8.2.1 Overview

<b>Menu</b>	<b>480 Event journal</b>
Menu access	<b>Main menu &gt; Production info&gt; Event journal</b>
Example display	<pre>480 Event journal ----- -&gt;External events Change events</pre>

The event journal contains the messages relating to the following events:

- Parameter changes - Changes to all parameters influencing the energy production and therefore the revenue production.
- External events - Problems with the insulation and grounding

<b>Sub-menu</b>	<b>Description</b>
481 External events	A list of all external events.
482 Change events	A list of parameter changes made via the display or via RS-485.

### 8.2.2 External Events Menu

#### Description

<b>Menu</b>	<b>481 External events</b>
Menu access	<b>Main menu &gt; Production info&gt; Event journal &gt; External events</b>
Example display	<pre>481 External events 18.06.2013 17:29:56 L1 Islanding Begin</pre>

The external event message has the following structure:

2nd line	Date and time when the external event occurred.
3rd line	Short description of the failure (see chapter "8.3 Troubleshooting and correction")
4th line	Additional information, e.g., "Begin" for the occurrence of an event or "End" for the disappearance of an event.

### 8.2.3 Change Events Menu

#### Description

The **482 Change events** menu contains a chronological list of all changes to parameters influencing the energy production and thus also the revenue.

<b>Menu</b>	<b>482 Change events</b>
Menu access	<b>Main menu &gt; Production info&gt; Event journal &gt; Change events</b>
Example display	<pre>482 Change events 18.06.13 17:29:56 D Max. power:      100% Max. power:      90%</pre>

The parameter change entry has the following structure:

<b>Menu</b>	<b>482 Change events</b>
2nd line	Date and time when the external event occurred. Source of the change: D: Display E: External (RS-485) S: System
3rd line	Name of the changed parameter + previous value
4th line	Name of the changed parameter + new value

### 8.3 Troubleshooting and Correction

#### 8.3.1 External Events / Insulation and Grounding Failures

The **411 Current overview** menu shows one of the following messages:

```
411 Current overview
Now:                -W
Day:                0Wh
External events
```

```
411 Current overview
Now:                -W
Day:                0Wh
Insulation
```

1. To receive a more exact description of the problem, press the  key in the **411 Current overview** menu.

→ The **External events** menu is displayed.

```
External events
PV1 ISO running fail
PV1 ISO startup fail
-----
```

The menu contains a list of all active messages relating to external events and insulation/grounding.

2. Press the  key again.

→ The **480 Event journal** menu containing the detailed message text is displayed (see "8.2 Event journal").

```
480 Event journal
-----
->External events
Change events
```

3. Select the entry **External events** and press the  key again.

```
480 Event journal
-----
->External events
Change events
```

→ The **481 External events** menu is displayed.

```
481 External events
18.06.2013 17:29:56
L1 Islanding
Begin
```

Alternatively, you can also directly open the **483 External events** menu via the "Go to menu" function, see chapter "12.3.1 'Go to menu' function".

The following table shows the failure messages that can appear in the **483 External events** menu and provides troubleshooting and correction suggestions.

LED Status		Display message	Message description	Fault correction
Green	<ON>	Warning ###	Internal failure ("Warning" + three-digit number)	▶ Please contact Delta Support.
Red	<OFF>			
Yellow	<Flash>			
Green	<OFF>	Failure ###	Internal failure ("Failure" + three-digit number)	▶ Please contact Delta Support.
Red	<OFF>			
Yellow	<ON>			
Green	<OFF>	L1 Voltage failure	AC overvoltage or undervoltage on phase L.	▶ Check the grid voltage shown on the display (menu <b>412 Current data AC</b> ). ▶ If no voltage is present, check the circuit breaker.
Red	<OFF>			
Yellow	<ON>			
Green	<OFF>	L1 Frequency error	AC high frequency or low frequency on phase L.	▶ Check the grid frequency shown on the display (menu <b>412 Current data AC</b> ). ▶ If no voltage is present, check the automatic circuit breaker.
Red	<OFF>			
Yellow	<ON>			
Green	<OFF>	L1 Islanding	Frequency shift failure on phase L.	▶ Ask your electricity supply company about the actual state of the grid. ▶ Check the installation. ▶ Restart the solar power inverter. Contain your maintenance technician if the failure persists.
Red	<OFF>			
Yellow	<ON>			
Green	<OFF>	PV Power too low	The solar power is too low.	Insufficient solar irradiation (dawn/dusk).. ▶ Check the PV cell voltage shown on the display (menu <b>416 Current data PV</b> ).
Red	<OFF>			
Yellow	<ON>			

LED Status		Display message	Message description	Fault correction
Green	<OFF>	PV1 ISO startup	The startup insulation is too low.	
Red	<ON>	fail	▶ Check the insulation resistance at the DC side of the PV modules.	
Yellow	<OFF>			
Green	<OFF>	PV1 ISO running	Residual current excess the safety standard.	
Red	<ON>	fail	▶ Check the insulation resistance at the DC side of the PV modules.	
Yellow	<OFF>			

### 8.3.2 Internal Failures

In the case of an internal failure, the message "Warning XXX" or "Failure XXX" is displayed in the **411 Current overview** menu. XXX stands for a 3-digit failure number.

```

411 Current data
L1                _W
Day:              _Wh
Warning 123

```

```

411 Current data
L1                _W
Day:              _Wh
Failure 351

```

In the case of internal failures, always contact the Solectria Support Team (see address list on the rear cover of this manual).

### 8.3.3 Other LED and Display Messages

LED Status		Display message	Message description Fault correction
Green	<Flash>	PV1 Voltage too low	The PV1 voltage is too low.
Red	<OFF>		There is insufficient solar irradiation.
Yellow	<OFF>		▶ Check the PV cell voltage shown on the display (menu <b>416 Current data PV</b> ).
Green	<ON>	L1 Power reduction	Power reduction active for L1.
Red	<OFF>	PV1 PW limit to Pn	Power limiting active for PV1.
Yellow	<OFF>	PV1 Temp derating	Temperature derating active for PV1. Reduced electricity production.  The internal temperature of the solar power inverter lies between +45 and +70 °C.  ▶ Check the ventilation of the solar power inverter.  ▶ Prevent direct sunlight from reaching the solar power inverter.

### 8.4 Displaying Grid Settings

#### Description

The actual grid settings can be displayed using the **131 View grid setup** menu. The contents of this menu are write-protected.

Menu	131 View grid setup
Menu access	<b>Main menu &gt; Install settings &gt; Grid selection &gt; View grid setup</b>
Example display	<pre> 131 View grid setup -&gt;Grid:      US 208 D Fnom:      --.--Hz           </pre>

If a power limit was set when the inverter was commissioned, then the following message is displayed before the menu opens:

```

The maximum power
of that inverter
has been limited to
##.##kW
    
```

## 8.5 Internal Log

### Description

The internal log contains information on the internal failures that have occurred.

<b>Menu</b>	<b>620 Internal log</b>
Menu access	<b>Main menu &gt; Diagnostic&amp;Alarm &gt; Internal log</b>
Example display	<pre>620 Internal log 12.04.12 7:39:25 126 127</pre>

Parameter change entries have the following structure:

3rd Line	Date and time when the external event occurred.
4th Line	Number(s) of the internal failure(s)

## 8.6 Maintenance



### Lethal danger from hazardous voltage.

Hazardous voltage exists while the inverter is operating. Hazardous voltage may still be present 5 minutes after all power sources have been disconnected.



▶ Never open the inverter. The inverter contains no components that are user serviceable. Opening the cover will void the warranty.

Ensure that the inverter is not covered and has sufficient air flow during operation.

Regularly clean the inverter to prevent soiling of the enclosure.

## 9 Repair



### Danger of death from hazardous voltage.

Hazardous voltage exists while the inverter is operating. Hazardous voltage may still be present 5 minutes after all power sources have been disconnected.



▶ Never open the inverter. The inverter contains no components that are user serviceable. Opening the cover will void the warranty.



The inverter contains no components that are user serviceable.

## 10 Removal, Transport, Storage, Disposal



### **Danger of death or severe injuries from dangerous voltage**

- ▶ Disconnect the inverter from the AC grid before removing the AC conductors.
- ▶ Verify absence of AC voltage before removing conductors.



### **Danger of death or severe injuries from danger voltage**

Dangerous voltages can be present at the DC connections of the inverter.

- ▶ Never disconnect the PV modules when the inverter is connected to AC grid or DC disconnect is on. First, switch off the AC conductors grid so that the inverter cannot feed energy into the grid. Then, open the DC disconnect.
- ▶ Verify absence of DC voltage before removing conductors.



### **Danger of injury due to heavy weight**

The inverter is heavy (see “11. Technical Data”, p. 71). Incorrect handling can lead to injuries.

- ▶ The inverter must be lifted and carried by two people.

### 10.1 Removal

1. Switch off the AC breaker and verify absence of AC voltage.
2. Open the DC disconnect, verify the absence of DC voltage on both the inverter and array sides, then disconnect PV array.
3. Remove DC and AC conductors and conduits from the inverter.
4. Unscrew the inverter from the wall bracket.
5. Lift the inverter from the wall bracket.
- 6.

### 10.2 Transport

Always transport the inverter in the original packaging or packaging of the same quality.

### 10.3 Storage

Always store the inverter in the original packaging or packaging of the same quality. Observe the specifications relating to storage conditions described in Section 11: “Technical data”.

### 10.4 Disposal

Dispose of the inverter in an appropriate manner according to the legal requirements of your country, state and municipality.



## 11. Technical Data

INPUT (DC)	PVI 3800TL	PVI 5200TL	PVI 6600TL	PVI 7600TL
Max. recommended PV power	4580 W <sub>p</sub>	6200 W <sub>p</sub>	8000 W <sub>p</sub>	9100 W <sub>p</sub>
Max. System Voltage	600 V			
Operational Voltage range	120 ... 550 V			
Full power MPP range	200... 500 V			
Max. current	20 A	15 A per MPP tracker	18 A per MPP tracker	20 A per MPP tracker
Max. input short circuit current (I <sub>sc</sub> x 1.25)	24 A	48 A (24 A per MPP tracker)		
Max. allowed imbalance power	-	33% / 67% <sup>1)</sup>		
DC disconnect	Internal			
MPP tracker	1	2	2	2
MPP efficiency	99.5%, dynamic			

OUTPUT (AC)	PVI 3800TL	PVI 5200TL	PVI 6600TL	PVI 7600TL
Nominal power	3800 W	5200 W	6600 W	7600 W
Max. power <sup>2)</sup>	3300 W @ 208 V / 3800 W @ 240 V	5200 W @ 208 V / 5200 W @ 240 V	6600 W @ 208 V / 6600 W @ 240 V	6600 W @ 208 V / 7600 W @ 240 V
Voltage range	-12%/+10%			
Max. continuous output current	16 A	27.5 A		32 A
Nominal frequency	60 Hz			
Frequency range	59.3-60.5 Hz			
Night consumption	< 2 W			
Total harmonic distortion @ nominal power	< 3%			
Power factor @ nominal power	Unity, >0.99			
Max. output overcurrent protection	28A			56A <sup>3)</sup>
Reactive power capability	Yes			

GENERAL SPECIFICATION	PVI 3800TL	PVI 5200TL	PVI 6600TL	PVI 7600TL
Max efficiency	98.0%			
CEC efficiency	97.5% @ 208V / 97.5% @ 240V			
Operating temperature	-13 to +158 °F (-25 to +70 °C) / Derate above 122 °F (50 °C)			
Storage temp.	-40 to +185 °F (-40 to +85 °C)			
Humidity	0 ... 100%			
Max operating altitude	2000 m above sea level			

MECHANICAL DESIGN	PVI 3800TL	PVI 5200TL	PVI 6600TL	PVI 7600TL
Dimensions L x W x D inches (L x W x D mm)	17.5 x 15.8 x 8.5 in. (445 x 401 x 216)		26.8 x 15.8 x 8.5 in. (680 x 401 x 216 mm)	
Weight	43 lbs (19.5 kg)		65 lbs. (29.5 kg)	
Cooling	Convection			
AC connectors	Screw terminals in connection box			
DC connectors	Screw terminals in connection box			
Communication interface	RS-485			
Display	3 LEDs, 4-line LCD			
Enclosure material	Aluminum			

- 1) Un-balanced PV input allowed, maximum input power for each MPP tracker is limited with 67% rating power and total input is limited with 100% rating power. See section 4.7.
- 2) The maximum AC power value indicates the power an inverter might be able to deliver, but such a maximum AC power may not necessarily be achieved.
- 3) Max. output fault current and duration is 140Apk, 2ms duration @208V, 116.8Apk, 6.15ms duration @240V.

STANDARDS / DIRECTIVES	PVI 3800TL	PVI 5200TL	PVI 6600TL	PVI 7600TL
Electronics protection rating	NEMA 4, IEC 60068-2-11 (Salt mist)			
Safety	UL 1741, CSA 22.2 No. 107-01			
SW Approval	UL 1998			
Isolation Monitor Interrupt (IMI)	NEC 690.35, UL1741 CRD			
Unintentional Islanding protection	IEEE 1547, IEEE 1547.1			
EMC	FCC part 15 A & B, ICES-003			
AFCI	UL1699B (Type 1), NEC 690 2014			

WARRANTY	PVI 3800TL	PVI 5200TL	PVI 6600TL	PVI 7600TL
Standard warranty	10 years			

Utility interconnection voltage and frequency trip limits and trip times for all models:

Simulated utility source		Maximum time (sec) at 60Hz before cessation of current to the simulated utility
Voltage (V)	Frequency (Hz)	
< 50% V	Rated (60 Hz)	0.16
50% V ≤ V < 88% V	Rated (60 Hz)	2
110% V < V < 120% V	Rated (60 Hz)	1
120% V ≤ V	Rated (60 Hz)	0.16
Rated	f > 60.5	0.16
Rated	f > 59.3	0.16

Trip limit and trip time accuracy for all models:

Voltage:	±1 V (L-L)
Frequency:	±0.01Hz
Time:	1%, but not less than 100ms

## 11.1 FCC Compliance Information

SOLECTRIA RENEWABLES, LLC. string inverters, Model PVI 3800TL, PVI 5200TL, PVI 6600TL and PVI 7600TL.

This device complies with Part 15 of the FCC Rules. Operation is subject to the following conditions:

- (1) This device may not cause harmful interference, and
- (2) This device must accept any interference, including interference that may cause undesired operation.

Note: This equipment has been tested and found to comply with the limits for a Class B digital device, pursuant to part 15 of the FCC Rules. These limits are designed to provide reasonable protection against harmful interference in a residential installation. This equipment generates, uses and can radiate radio frequency energy and, if not installed and used in accordance with the instructions, may cause harmful interference to radio communications. However, there is no guarantee that interference will not occur in a particular installation. If this equipment does cause harmful interference to radio or television reception, which can be determined by turning the equipment off and on, the user is encouraged to try to correct the interference by one or more of the following measures:

- Reorient or relocate the receiving antenna
- Increase the separation between the equipment and the receiver
- Connect the equipment into an outlet on a circuit different from that to which the receiver is connected.
- Consult the dealer or an experienced radio/TV technician for help.
- The user is cautioned that changes or modifications not expressly approved by SOLECTRIA RENEWABLES could void the user's authority to operate this equipment.

Contact YASKAWA - SOLECTRIA SOLAR for more information:

### **YASKAWA - SOLECTRIA SOLAR**

360 Merrimack Street  
Building 9, Floor 2  
Lawrence, MA 01843  
USA

<http://solectria.com/products/grid-tied-inverters/residential-tl-string-inverters/pvi-3800-7600tl/>

Support E-mail: [service@solectria.com](mailto:service@solectria.com)

Support Hotline: 978-683-9700

Monday to Friday from 8:30am to 5:00pm (apart from official Bank Holidays)

## 11.2 Canadian Compliance Information

This Class B digital apparatus complies with Canadian ICES-003.

## 12 Appendix

### 12.1 Overview of Setting Options

The following table contains an overview of all settings that can be made in the inverter.

Function / Characteristic	Short description	Menu Manual chapter
<b>Options</b>		<b>200 Options</b> "7.4 Options settings"
Shading	For setting up the extended MPP tracking	<b>210 Shading</b> "7.4.1 Shading"
<b>Display settings</b>		
Date and time	For setting the date and time	<b>110 Date and time</b> "7.2.1 Date and time"
Date and time format	For setting the date and time formats	<b>111 Format</b> "7.2.2 Date and time formats"
Contrast	For setting the contrast	<b>120 Display settings</b> "7.2.3 Contrast"
Standard menu	For selecting the display to be shown when no key has been pressed for a certain period of time.	<b>800 Standard</b> "7.5 Standard menu"
<b>Monitoring</b>		
RS-485 settings	For setting the RS-485 ID and the baud rate and for switching the termination resistor on and off	<b>150 RS-485</b> "7.2.5 RS-485"
<b>Showing statistics</b>		
Showing statistics on the display	-	<b>400 Production info</b> "6. Production information"
<b>Feed-in settings</b>		
Currency, revenue per kWh	For setting the currency and the revenue per kWh	<b>471 Feed-in settings</b> "7.3 Grid feed-in settings"

## 12.2 Order Numbers

RS-485 cable

### RS-485 connection cable

Cable for connecting inverters

Please contact Solectria for available options.

## 12.3 Overview of Menu Structure

### 12.3.1 "Go to menu" Function







You can use the "Go to menu" function to directly navigate to a particular menu.

1. To open the Go to menu function, press and hold the  key on the inverter for at least 3 seconds.

→ **Go to menu** opens.

```
Go to menu
-----
->Menu:      000
```

2. Press the  key to enter the menu number.  
→ The first digit flashes.
3. Enter the first digit of the menu number using the keys. Press the   key when you are finished.  
→ The second digit flashes.
4. Enter the second and third digit in the same manner.
5. Press the  key.  
→ The menu corresponding to the entered menu number is displayed.

### 12.3.2 Installation Settings (100)

100 Installation	Explanation
130 Grid selection	Display the grid settings, change the grid
140 RS-485	Change RS-485 settings

110 Date and time	Explanation
Date: 18/06/2013	Date
Time: 15:12:23	Time
111 Format	Date and time formats

111 Format	Explanation
Date: DD/MM/YYYY	Date format
Time: 24h	Time format (12h or 24h)

120 Display settings	Explanation
Contrast: 10	1...10

130 Grid selection	Explanation
131 View grid setup	Actual grid settings
132 Grid change	Set a different grid

140 RS-485	Explanation
ID: ---	If multiple inverters are connected via RS-485, then each inverter must have a different ID. (1 ... 254)
Baud rate:	Baud rate (2400 / 4800 / 9600 / 19200 / 38400)

### 12.3.3 Shading (210)

Mode	Explanation
Disable	Monitoring is deactivated.
High	High shading, time cycle: 0.5 hours
Medium	Medium shading, time cycle: 2 hours
Low	Low shading, time cycle: 4.5 hours

210 Shading	Explanation
Mode                      Disable	Disabled / High / Medium / Low

### 12.3.4 Production Information (400)

400 Production info	Explanation
410 Current data	Current power and energy values. Messages on the current operating status.
420 Day statistics	Statistics for the current day
430 Week statistics	Statistics for the current calendar week
440 Month statistics	Statistics for the current calendar month
450 Year statistics	Statistics for the current calendar year
460 Total statistics	Statistics for the entire operating period
470 Feed-in settings	Settings for currency and revenue per kWh
480 Event journal	Messages off events
490 History	Power and energy value of latest 7 days

410 Current data	Explanation
411 Current overview	Current status
412 Current data AC	AC = AC side
416 Current data PV	PV = module side
41A Date and time	Date and time
41B Current insulation	Insulation resistance value



411 Current overview		Explanation
Now:	200W	Current active power
Day:	2000Wh	Energy production current day
Normal operation		Current status messages

412 Current data AC		Explanation
L1 voltage:	---V	Voltage
L1 Freq.:	---Hz	Frequency
L1 Current:	---A	Phase current
L1 P:	---W	Active power
L1 Q:	---Var	Apparent power
L1 DC inj.:	---mA	Feed-in current

416 Current data PV		Explanation
PV1 Voltage:	---V	Voltage on the PV side
PV1 Current:	---A	Current on the PV side

41A Date and time		Explanation
Date:	18.06.2013	Current date
Time:	15:05:19	Current time

41B Current insulation		Explanation
R iso:	---kΩ	Insulation resistance at DC+

<b>420 Day statistics</b>	<b>Explanation</b>
421 Day statistics AC	AC = AC side
422 Day statistics DC	DC = DC side
423 Day statistics ISO	ISO = Insulation
<b>430 Week statistics</b>	
<b>440 Month statistics</b>	
<b>450 Year statistics</b>	
<b>460 Total statistics</b>	
<b>470 Feed-in settings</b>	
<b>480 Event journal</b>	
<b>490 History</b>	

<b>421 Day statistics AC</b>	<b>Explanation</b>
Energy:                    ---Wh	Energy
Runtime:                    -:--h	Runtime
Revenue:                    ---USD	Revenue
L1 Imax:                    -.-A	Maximum current
L1 Pmax:                    ---W	Maximum active power
L1 Qmax:                    ---Var	Maximum apparent power
L1 Qmin:                    ---Var	Minimum apparent power
<b>431 Week statistics AC</b>	
<b>441 Month statistics AC</b>	
<b>451 Year statistics AC</b>	
<b>461 Total statistics AC</b>	

<b>491 Day</b>		<b>Explanation</b>
Energy:	---Wh	Energy
Runtime:	-:--h	Runtime
Revenue:	---USD	Revenue
L1 I <sub>max</sub> :	-...A	Maximum current
L1 P <sub>max</sub> :	---W	Maximum active power
L1 Q <sub>max</sub> :	---Var	Maximum apparent power
L1 Q <sub>min</sub> :	---Var	Minimum apparent power
<b>492 Day</b>		
<b>493 Day</b>		
<b>494 Day</b>		
<b>495 Day</b>		
<b>496 Day</b>		
<b>497 Day</b>		

<b>422 Day statistics DC</b>		<b>Explanation</b>
PV1 I <sub>max</sub> :	---A	Max. current
PV1 U <sub>max</sub> :	---V	Max. voltage
PV1 P <sub>max</sub> :	---W	Max. power
<b>432 Week statistics DC</b>		
<b>442 Month statistics DC</b>		
<b>452 Year statistics DC</b>		
<b>462 Total statistics DC</b>		

423 Day statistics ISO	Explanation
R ISO max: ---kΩ	Max. insulation resistance
R ISO min: ---kΩ	Min. insulation resistance
433 Week statistics ISO	
443 Month statistics ISO	
453 Year statistics ISO	
463 Total statistics ISO	

470 Feed-in settings	Explanation
Currency USD	Define the currency
USD / kWh: #.##	Define the revenue pro kWh

480 Event journal	Explanation
481 External events	Overview of all external events and insulation/grounding problems
482 Change events	Overview of all parameter changes

### 12.3.5 Diagnostics and Alarms (600)

The reports that are displayed depend on the grid configuration:

- Internal log (is always displayed)

600 Diagnostic&Alarm	Explanation
620 Internal log	Firmware update

### 12.3.6 Software Version/Inverter Data (700)

700 Inverter info	Explanation
710 Software vers.	Version of the installed software
720 Inverter data	Production date and serial number

### 12.3.7 Standard Menu (800)

800 Standard menu	Explanation
Menu number:	Number of the menu that is to be displayed as the standard menu.

## 13 Glossary

### **AC**

Abbreviation for “Alternating Current”.

### **AHJ**

Abbreviation for “Authority Having Jurisdiction” (electrical inspector).

### **Basic Insulation**

Insulation to provide basic protection against electric shock.

### **CEC**

Abbreviation for the California Energy Commission

### **CEC Efficiency**

CEC Efficiency is the California Energy Commission Efficiency rating, a performance rating for modules and inverters based on the real environment that a system will be in.

### **CSA**

Abbreviation for the Canadian Standards Association.

### **DC**

Abbreviation for “Direct Current”.

### **EMC**

The Electro-Magnetic Compatibility (EMC) concerns the technical of the mutual influencing of electrical devices through electromagnetic fields caused by them.

### **FCC**

Federal Communications Commission.

### **Galvanic isolation**

No conductive connection between two component parts.

### **GEC**

Grounding Electro Conductor

### **GET**

Grounding Electro Terminal

### **IEEE**

The Institute of Electrical and Electronics Engineers or IEEE is an international non-profit, professional organization for the advancement of technology related to electricity.

### **IMI**

Isolation Monitor Interrupter

### **Isc**

Short Circuit Current

### **Local utility company**

A local utility company is a company that distributes electricity over the grid.

**MPP**

The Maximum Power Point is the point on the current-voltage (I-V) curve of an array or string, where the product of current and voltage has its maximum value.

**NEC**

The National Electrical Code (NEC), or NFPA 70, is a United States standard for the safe installation of electrical wiring and equipment.

**Power dissipation**

Power dissipation is designated as the difference between absorbed power and power of a device or process yielded. Power dissipation is released mainly as heat.

**PV cell**

PV cells are large-surface photodiodes which convert light energy (generally sunlight) into electrical energy. This comes about by utilization of the photoelectric effect (photovoltaic).

**PV array**

System comprising of a number of PV modules.

**PV module**

Part of a PV generator; converts PV energy into electrical energy.

**RJ-45**

Abbreviation for standardized eight-pole electrical connector connection. RJ stands for Registered Jack (standardized socket).

**RS-485 (EIA485)**

Differential voltage interface on which the genuine signal is transmitted on one core and the negated (or negative) signal on the other core.

**Inverter**

An electrical device which converts DC direct voltage into AC voltage and/or direct current into alternating current.

**String**

Designates a group of electrical PV modules amended in series.

**UL**

Stands for Underwriters Laboratory, an organization that sets standards for different product categories and tests products to make sure they meet the standards.

**Voc**

Open Circuit Voltage

## 14 Certificates

Please check our web site for the most recent certificates at: <http://solectria.com/products/grid-tied-inverters/residential-tl-string-inverters/pvi-3800-7600tl/>.



# Certificate of Compliance

**Certificate:** 2716237

**Master Contract:** 260655

**Project:** 70029191

**Date Issued:** April 21, 2015

**Issued to:** SOLECTRIA RENEWABLES LLC  
Bldg 9 360 Merrimack Street  
Lawrence,  
MA 01843,  
USA  
**Attention:** Chinedu Igboke

*The products listed below are eligible to bear the CSA Mark shown with adjacent indicators 'C' and 'US' for Canada and US or with adjacent indicator 'US' for US only or without either indicator for Canada only*



*Kyle Song*

**Issued by:** Kyle Song

### PRODUCTS

**CLASS 5311 09** - POWER SUPPLIES - Distributed Generation Power Systems Equipment  
**CLASS 5311 89** - POWER SUPPLIES - Distributed Generation - Power Systems Equipment  
- Certified to U.S. Standards

Transformerless Utility Interactive Inverter, Models PVI-3800TL, PVI-5200TL, PVI-6600TL and PVI-7600TL, permanently connected.

### Notes:

For details related to rating, size, configuration, etc. reference should be made to the CSA Certification Record.

### APPLICABLE REQUIREMENTS

CSA-C22.2 No.107.1-01 - General Use Power Supplies

\*UL Std No. 1741-Second Edition - Inverters, Converters, Controllers and Interconnection System Equipment For Use With Distributed Energy Sources (January 28, 2010)



## **15      Warranty**

The current warranty and RMA statement for the product is available online at <http://solectria.com/support/documentation/warranty-information/grid-tied-inverter-warranty-letter/>. If you do not have access to the internet or to request a copy to be mailed to you, please contact the Customer Service Department 978-683-9700.

**Yaskawa - Solectria Solar**

360 Merrimack Street  
Building 9, 2nd floor  
Lawrence, Massachusetts 01843  
USA

Tel:	978.683.9700
Fax:	978.683.9702
Sales/General Info:	<a href="mailto:inverters@solectria.com">inverters@solectria.com</a>
Customer Support:	<a href="mailto:service@solectria.com">service@solectria.com</a>
Website:	<a href="http://www.solectria.com">www.solectria.com</a>



5013209981

**YASKAWA**  
**SOLECTRIA SOLAR**