

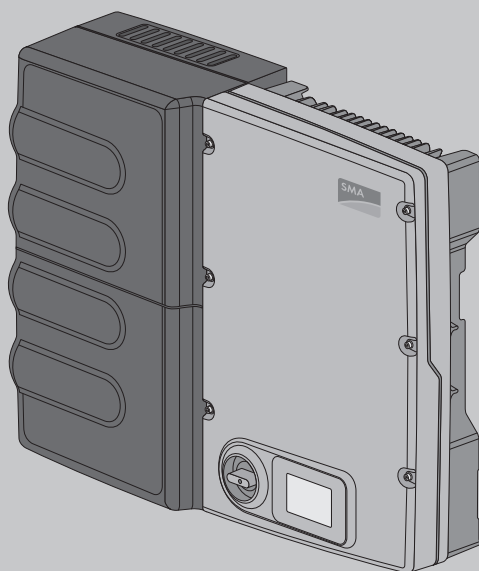

Operating Manual

SUNNY BOY 3600 / 5000 SMART ENERGY BATTERY PACK SMART ENERGY



Legal Provisions

The information contained in these documents is property of SMA Solar Technology AG. Any publication, whether in whole or in part, requires prior written approval by SMA Solar Technology AG. Internal reproduction used solely for the purpose of product evaluation or other proper use is allowed and does not require prior approval.

SMA Warranty

You can download the current warranty conditions from the Internet at www.SMA-Solar.com.

Trademarks

All trademarks are recognized, even if not explicitly identified as such. A lack of identification does not mean that a product or symbol is not trademarked.

The BLUETOOTH® word mark and logos are registered trademarks of Bluetooth SIG, Inc. and any use of these marks by SMA Solar Technology AG is under license.

Modbus® is a registered trademark of Schneider Electric and is licensed by the Modbus Organization, Inc.

QR Code is a registered trademark of DENSO WAVE INCORPORATED.

Phillips® and Pozidriv® are registered trademarks of Phillips Screw Company.

Torx® is a registered trademark of Acument Global Technologies, Inc.

SMA Solar Technology AG

Sonnenallee 1

34266 Niestetal

Germany

Tel. +49 561 9522-0

Fax +49 561 9522-100

www.SMA.de

E-mail: info@SMA.de

© 2004 to 2014 SMA Solar Technology AG. All rights reserved.

Table of Contents

1	Information on this Document	6
2	Safety	8
2.1	Intended Use	8
2.2	Skills of Qualified Persons	9
2.3	Safety Precautions	9
3	Scope of Delivery	12
4	Product Description.....	13
4.1	Sunny Boy and Battery Pack	13
4.2	Interfaces and Functions of the Inverter	16
4.3	System Overview.....	17
5	Mounting	22
5.1	Requirements for Mounting	22
5.2	Mounting the Inverter and Battery Pack	25
6	Electrical Connection.....	27
6.1	Overview of the Connection Areas.....	27
6.1.1	View from Below	27
6.1.2	Interior View	28
6.2	AC Connection	28
6.2.1	Requirements for the AC Connection.....	28
6.2.2	Connecting the Inverter to the Utility Grid.....	30
6.2.3	Connecting Additional Grounding	31
6.3	Connecting the Network and SMA Energy Meter	32
6.4	DC Connection	34
6.4.1	Requirements for the DC Connection.....	34
6.4.2	Connecting the PV Array	35
6.5	Connecting the Inverter and the Battery Pack	37
7	Commissioning	39
7.1	Procedure.....	39
7.2	Configuring the Country Data Set.....	39
7.3	Commissioning the Inverter.....	40

7.4	Self-Test in Accordance with CEI 0-21 for PV Systems ≤ 6 kW	41
7.4.1	Starting the Self-Test.....	41
7.4.2	Restarting the Self-Test	43
8	Configuration	44
8.1	Procedure.....	44
8.2	Changing the Display Language.....	44
8.3	Integrating the Inverter into the Network.....	45
8.4	Creating a Sunny Portal System.....	46
8.5	Changing Operating Parameters.....	46
8.6	Setting the Lower Battery Charge Limit	47
8.7	Setting the Active Power Limit at the Grid-Connection Point.....	48
8.8	Setting the Active Power Limitation in case of PV System Control Failure	48
8.9	Ensuring Communication with the Purchased Electricity Meter	49
8.10	Deactivating Grounding Conductor Monitoring.....	49
8.11	Setting SMA OptiTrac Global Peak.....	50
9	Operation.....	51
9.1	LED Signals.....	51
9.2	Display Overview.....	51
9.3	Calling Up Display Messages of the Start-Up Phase.....	53
9.4	Activating and Operating the Display	53
10	Disconnecting the Inverter from Voltage Sources.....	54
11	Technical Data.....	57
11.1	DC/AC	57
11.2	General Data	58
11.3	Battery Pack.....	60
11.4	Protective Devices.....	60
11.5	Climatic Conditions	61
11.6	Equipment	61
11.7	Torques	61
11.8	Data Storage Capacity.....	61

12 Accessories	62
13 Contact	63
14 EC Declaration of Conformity	66

1 Information on this Document

Validity

This document is valid for the following device types from firmware version 2.3.35.R:

- SB 3600SE-10 (Sunny Boy 3600 Smart Energy)
- SB 5000SE-10 (Sunny Boy 5000 Smart Energy)

Target Group



This document is intended for qualified persons and end users. Only qualified persons with the appropriate skills (see Section 2.2 "Skills of Qualified Persons", page 9) are allowed to perform some of the tasks described in this document. Such tasks are marked with a warning symbol and the caption "Qualified person". Tasks that do not require any particular qualification are not marked and can also be performed by end users.



Additional Information

Links to additional information can be found at www.SMA-Solar.com:

Document title	Document type
SMA Smart Home - The System Solution for More Independence	Planning Guidelines
SUNNY BOY 3600 / 5000 SMART ENERGY BATTERY PACK SMART ENERGY	Service Manual
SMA Energy Meter	Installation Manual
Parameter List	Technical Information
Efficiency and Derating	Technical Information
Order Form for the SMA Grid Guard Code	Certificate
Shade Management	Technical Information
Webconnect Systems in Sunny Portal	User Manual
Sunny Home Manager in Sunny Portal	User Manual

Symbols

Symbol	Explanation
 DANGER	Indicates a hazardous situation which, if not avoided, will result in death or serious injury
 WARNING	Indicates a hazardous situation which, if not avoided, can result in death or serious injury
 CAUTION	Indicates a hazardous situation which, if not avoided, can result in minor or moderate injury
NOTICE	Indicates a situation which, if not avoided, can result in property damage

Symbol	Explanation
 QUALIFIED PERSON	Sections describing activities to be performed by qualified persons only
	Information that is important for a specific topic or goal, but is not safety-relevant
<input type="checkbox"/>	Indicates a requirement for meeting a specific goal
<input checked="" type="checkbox"/>	Desired result
	A problem that might occur

Nomenclature

Complete designation	Designation in this document
Battery Pack Smart Energy	Battery Pack
Sunny Boy 3600 / 5000 Smart Energy	Inverter
Sunny Boy 3600 / 5000 Smart Energy with Battery Pack Smart Energy	Product

2 Safety

2.1 Intended Use

The inverter, the Battery Pack, the energy meters and if applicable, the Sunny Home Manager, make up a system for optimization of self-consumption in a household. The inverter is equipped with two MPP trackers and converts the direct current from the PV array into grid-compliant alternating current. The Battery Pack is used for the intermediate storage of the energy.

The product is designed for indoor use only.

The product must only be operated at ambient temperatures from 0°C to +40°C and at a relative humidity between 5% and 95%.

The product must not be exposed to any direct solar irradiation.

The product must not be installed in areas containing highly flammable materials or gases.

The product must not be mounted in potentially explosive atmospheres.

The inverter must only be operated with a Battery Pack type "BAT-2.0-A-SE-10" (status as of: March 2014). An updated list of batteries approved by SMA Solar Technology AG is available at www.SMA-Solar.com.

The product must only be operated with PV arrays of protection class II, in accordance with IEC 61730, application class A. The PV modules must be compatible with this product.

PV modules with a high capacity to ground must only be used if their coupling capacity does not exceed 1.4 µF (for information on how to calculate the coupling capacity, see the Technical Information "Leading Leakage Currents" at www.SMA-Solar.com).

The product must only be used in countries for which it is approved or released by SMA Solar Technology AG and the grid operator.

All components must remain within their permitted operating ranges at all times.

The product is not suitable for setting up a DC distribution grid.

Use this product only in accordance with the information provided in the enclosed documentation and with the locally applicable standards and directives. Any other application may cause personal injury or property damage.

Alterations to the product, e.g. changes or modifications, are only permitted with the express written permission of SMA Solar Technology AG. Making unauthorized changes will void the warranty and will normally result in invalidation of the operating permit. SMA Solar Technology AG shall not be held liable for any damages caused by such changes.

Any use of the product other than described in the Intended Use section does not qualify as intended use.

The enclosed documentation is an integral part of this product. Keep the documentation in a convenient place for future reference and observe all instructions contained therein.

All type labels must be permanently attached.

2.2 Skills of Qualified Persons

Only qualified persons are allowed to perform the activities marked in this document with a warning symbol and the caption "Qualified person". Qualified persons must have the following skills:

- Knowledge of how an inverter works and is operated
- Training in how to deal with the dangers and risks associated with installing and using electrical devices, batteries and systems
- Training in the installation and commissioning of electrical devices and systems
- Knowledge of the applicable standards and directives
- Knowledge of and compliance with this document, including all safety precautions
- Knowledge of and compliance with the documents of the battery manufacturer, including all safety precautions

2.3 Safety Precautions

This section contains safety precautions that must be observed at all times when working on or with the product.

To prevent personal injury and property damage and to ensure long-term operation of the product, read this section carefully and follow all safety precautions at all times.

DANGER

Danger to life due to high voltages of the PV array

When exposed to sunlight, the PV array generates dangerous DC voltage which is present in the DC conductors and the live components of the inverter. Touching the DC conductors or the live components can lead to lethal electric shocks. If you disconnect the DC connectors from the inverter under load, an electric arc may occur leading to electric shock and burns.

- Do not touch uninsulated cable ends.
- Do not touch the DC conductors.
- Do not touch any live components of the inverter.
- Have the inverter mounted, installed and commissioned by qualified persons with the appropriate skills only.
- If an error occurs, have it rectified by qualified persons only.
- Prior to performing any work on the inverter, disconnect it from all voltage sources as described in this document (see Section 10, page 54).

⚠ DANGER**Danger to life due to high voltages on the Battery Pack**

Lethal voltage is present at the pin connector for the power cable. Reaching into the pin connector for the power cable can result in lethal electric shock.

- Do not open the Battery Pack.
- Do not wipe over the Battery Pack with a damp cloth.
- Leave the protective caps on the pin connectors for the power cable and the data cable until the inverter cables are connected to the Battery Pack.
- Only operate the Battery Pack with its protective cover mounted. The protective cover is separately packed.
- Prior to performing any work on the inverter or the Battery Pack, disconnect the inverter from all voltage sources as described in this document (see Section 10, page 54).

⚠ DANGER**Danger to life due to electric shock**

Touching an ungrounded PV module or an array frame can cause a fatal electric shock.

- Connect and ground the PV modules, array frame and electrically conductive surfaces so that there is continuous conduction. Observe the applicable local regulations.

⚠ WARNING**Risk of chemical burns from electrolyte or toxic gases**

During normal operation, no electrolyte can leak from the Battery Pack and no toxic gases can form. Despite careful construction, if the Battery Pack is damaged or a fault occurs, it is possible that electrolyte may be leaked or toxic gases formed.

- Store the Battery Pack in a cool and dry place.
- Do not drop the Battery Pack or damage it with sharp objects.
- Only set the Battery Pack down on its back, i.e., on the side with the mounting lugs.
- Do not open the Battery Pack.
- Only operate the Battery Pack at ambient temperatures between 0°C and +40°C.
- Do not install or operate the Battery Pack in potentially explosive atmospheres or areas of high humidity.
- If moisture has penetrated the Battery Pack (e.g. due to a damaged enclosure), do not install or operate the Battery Pack.
- In case of contact with electrolyte, rinse the affected areas immediately with water and consult a doctor without delay.

⚠ WARNING**Risk of burns due to hot enclosure parts**

Some parts of the enclosure can get hot during operation.

- During operation, do not touch any parts other than the enclosure lid of the inverter.

NOTICE**Damage to the inverter due to electrostatic discharge**

Touching electronic components can cause damage to or destroy the inverter through electrostatic discharge.

- Ground yourself before touching any component.

NOTICE**Damage to the display or the type label due to the use of cleaning agents**

- If the inverter is dirty, clean the enclosure, the cooling fins, the enclosure lid, the type label, the display and the LEDs using clear water and a cloth only.

3 Scope of Delivery

Check the scope of delivery for completeness and any externally visible damage. Contact your distributor if the scope of delivery is incomplete or damaged.

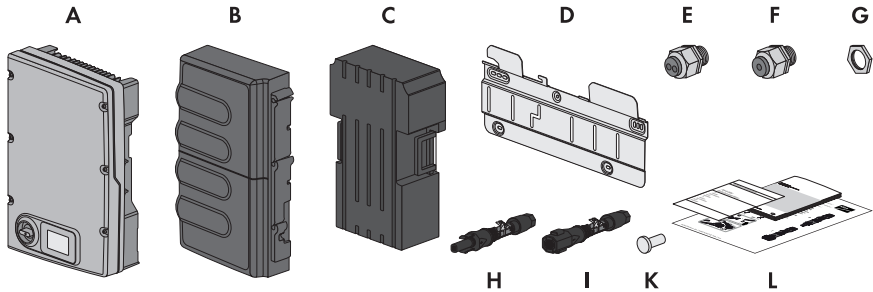

Figure 1: Components included in the scope of delivery

Position	Quantity	Designation
A	1	Inverter
B	1	Protective cover of the Battery Pack*
C	1	Battery Pack*
D	1	Wall mounting bracket
E	1	Cable gland M32x1.5 with two-hole cable support sleeve
F	1	Cable gland M32x1.5 with one-hole cable support sleeve
G	2	Counter nut for cable gland M32x1.5
H	4	Positive DC connector
I	4	Negative DC connector
K	8	Sealing plug
L	1	Operating manual, installation manual for DC connectors, supplementary sheet with default settings, supplementary sheet with information and data necessary for registration of the inverter in Sunny Portal, supplementary sheet with information on how to handle the Battery Pack*

* packed separately

4 Product Description

4.1 Sunny Boy and Battery Pack

The inverter, the Battery Pack, the energy meters and if applicable, the Sunny Home Manager, together make up a system for optimization of self-consumption in a household. The inverter is equipped with two MPP trackers and converts the direct current from the PV array into grid-compliant alternating current. The Battery Pack is used for the intermediate storage of the energy.

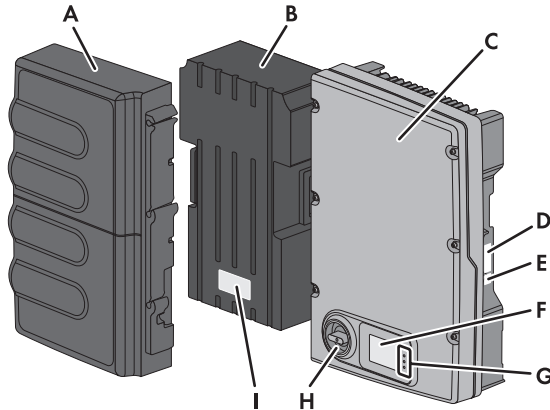















Figure 2: Layout of the Sunny Boy with Battery Pack

Position	Designation
A	Protective cover of the Battery Pack
B	Battery Pack
C	Enclosure lid
D	<p>Inverter type label</p> <p>The type label uniquely identifies the inverter. You will require the information on the type label to use the inverter safely and when seeking customer support from the SMA Service Line. You will find the following information on the type label:</p> <ul style="list-style-type: none"> • Device type (Model) • Serial number (Serial No.) • Date of manufacture • Device-specific characteristics
E	<p>Additional label</p> <p>On the additional label, you will find technical data of the battery and details for registering the inverter in Sunny Portal.</p>











Position	Designation
F	<p>Display</p> <p>The display shows the current operating data and events or errors.</p>
G	<p>LEDs</p> <p>The LEDs indicate the operating state of the inverter (see Section 9.1 "LED Signals", page 51).</p>
H	<p>DC load-break switch</p> <p>If the DC load-break switch is set to the position I, it establishes a conductive connection between the PV array, the inverter and the Battery Pack.</p> <p>Setting the DC load-break switch to the position O interrupts the DC circuit and disconnects the PV array and the Battery Pack completely from the inverter. Disconnection takes place at all poles.</p>
I	<p>Type label of the Battery Pack</p> <p>The type label uniquely identifies the Battery Pack. You will require the information on the type label to use the Battery Pack safely and when seeking customer support from the SMA Service Line. You will find the following information on the type label:</p> <ul style="list-style-type: none"> • Device type (Material number / type) • Serial number • Manufacturing code • Hardware and firmware version of the Battery Pack • Device-specific characteristics • Manufacturing week

Symbols on the Inverter and on the Type Label of the Inverter

Symbol	Explanation
	<p>Inverter</p> <p>Together with the green LED, this symbol indicates the operating state of the inverter.</p>
	<p>Observe the documentation.</p> <p>Together with the red LED, this symbol indicates an error (for troubleshooting, see service manual at www.SMA-Solar.com).</p>
	<p>Data transmission</p> <p>In SB 3600SE-10 / SB 5000SE-10 not assigned.</p>

Symbol	Explanation
	<p>Danger</p> <p>This symbol indicates that the inverter must be additionally grounded if additional grounding or equipotential bonding is required at the installation site (see Section 6.2.3 "Connecting Additional Grounding", page 31).</p>
	<p>Danger to life due to electric shock</p> <p>The product operates at high voltages. All work on the product must be carried out by qualified persons only.</p>
	<p>Risk of burns from hot surfaces</p> <p>The product can get hot during operation. Avoid contact during operation. Allow the product to cool down sufficiently before carrying out any work.</p>
	<p>Observe the documentation.</p> <p>Observe all documentation supplied with the product.</p>
	<p>Direct current</p>
	<p>The product does not have a transformer.</p>
	<p>Alternating current</p>
	<p>WEEE designation</p> <p>Do not dispose of the product together with the household waste but in accordance with the locally applicable disposal regulations for electronic waste.</p>
	<p>VDE certification mark</p> <p>The inverter and the Battery Pack are VDE-tested and comply with the current health and safety requirements. The inverter also complies with the requirements of the German Equipment and Product Safety Act.</p>
	<p>Danger to life due to high voltages in the inverter; observe the prescribed waiting time of five minutes.</p> <p>High voltages that can cause lethal electric shocks are present in the live components of the inverter. Prior to performing any work on the inverter, disconnect it from all voltage sources as described in this document (see Section 10, page 54).</p>

Symbols on the Battery Pack

Symbol	Explanation
	Danger to life due to high voltages The Battery Pack operates at high voltages. All work on the Battery Pack must be carried out by qualified persons only.
	Fire, naked light and smoking prohibited
	Use eye protection
	Keep out of reach of children
	Observe the documentation. Observe all documentation supplied with the Battery Pack and the inverter.
	Risk of chemical burns
	Risk of explosion
	Risk of injury when lifting the Battery Pack The Battery Pack is heavy (see Section 11 "Technical Data", page 57). Take care when lifting and transporting the Battery Pack.
	Do not dispose of the Battery Pack together with the household waste but in accordance with the locally applicable disposal regulations for batteries.
	Recycling code

4.2 Interfaces and Functions of the Inverter

The inverter can be equipped with the following interfaces and functions:

SMA Speedwire/Webconnect

SMA Speedwire/Webconnect is a type of communication based on the Ethernet standard, and allows you to connect the inverter to a Speedwire network. Webconnect enables data exchange between the inverter and Sunny Portal. Sunny Portal is an Internet portal which allows you to monitor PV systems and to visualize and present PV system data.

SMA OptiTrac Global Peak

SMA OptiTrac Global Peak is an advancement of SMA OptiTrac and allows the operating point of the inverter to follow the MPP precisely at all times. In addition, with the aid of SMA OptiTrac Global Peak, the inverter can detect the presence of several maximum power points in the available operating range, such as may occur particularly with partially shaded strings. SMA OptiTrac Global Peak is enabled by default.

Multifunction Relay

You can configure the multi-function relay for various operating modes. The multifunction relay is used, for example, to switch fault indicators on or off (for information on installation and configuration, see installation manual of the multifunction relay). The multifunction relay can be retrofitted.

4.3 System Overview

SMA Integrated Storage System

The SMA Integrated Storage System optimizes self-consumption in the household by the following measures:

- Intelligent intermediate storage of excess PV energy with the Battery Pack
- PV system monitoring and intelligent load control with Sunny Home Manager, SMA Energy Meter and SMA radio-controlled sockets

The Sunny Boy Smart Energy uses the Battery Pack for intermediate storage of excess PV energy. The Sunny Boy Smart Energy and the Sunny Home Manager receive the data from the connected energy meter and thus capture both feed-in and purchased electricity. The Sunny Home Manager receives location-based weather forecasts via the Internet and uses these to create a yield forecast for the PV system. In addition, the Sunny Home Manager determines how much energy is typically consumed in a household at different times of the day and uses this to create an individual load profile. Based on the load profile, the Sunny Home Manager determines the times at which the loads can be supplied with self-generated energy, and, for example, switches the loads which are connected to SMA radio-controlled sockets. The Sunny Home Manager transmits specifications to the Sunny Boy Smart Energy for charging and discharging the Battery Pack. If required by the grid operator, the Sunny Home Manager also limits the active power feed-in of the Sunny Boy Smart Energy, taking into consideration the current consumption in the household. If the maximum value for active power feed-in permitted by the grid operator is exceeded, the Sunny Home Manager transmits the setpoint for active power limitation to the Sunny Boy Smart Energy.

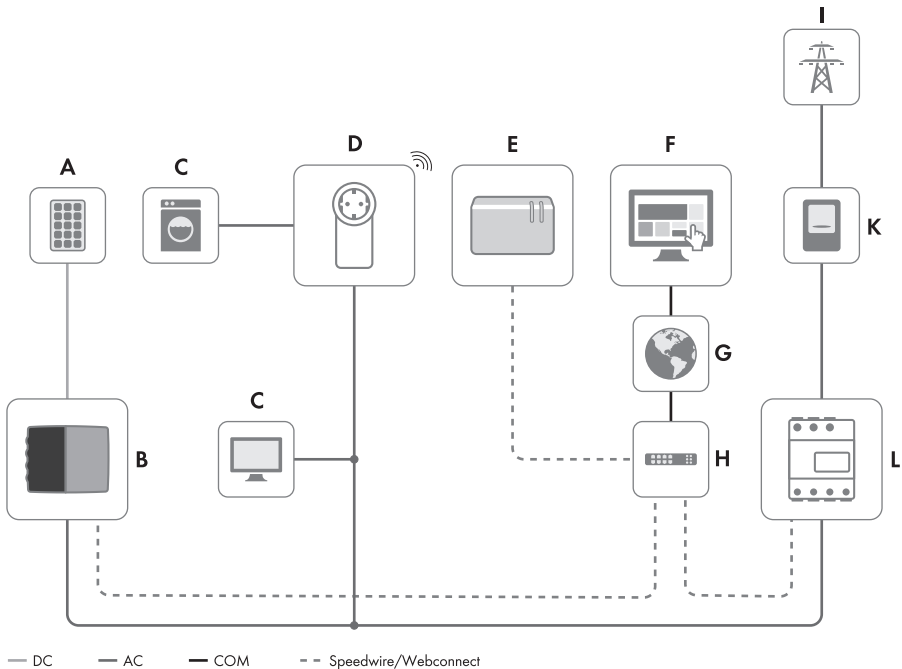

Figure 3: Overview of an Integrated Storage System (example)

Position	Designation
A	PV array
B	Inverter and Battery Pack
C	Load

Position	Designation
D	<p>SMA radio-controlled socket</p> <p>The SMA radio-controlled socket supports load control in households with Sunny Home Manager. The SMA radio-controlled socket carries out the following tasks:</p> <ul style="list-style-type: none"> • Implementation of Sunny Home Manager control commands • Measurement of the energy consumption of the connected load
E	<p>Sunny Home Manager</p> <p>In the Integrated Storage System, the Sunny Home Manager performs the following tasks:</p> <ul style="list-style-type: none"> • Creation of a yield forecast for the PV system based on local weather forecasts • Creation of an individual load profile • Control of SMA radio-controlled sockets • Control of charging and discharging the Battery Pack based on the yield forecast and the individual load profile • Dynamic limitation of active power feed-in by the inverter at the grid-connection point • Implementation of grid management specifications • Transmission of data to Sunny Portal
F	<p>Sunny Portal</p> <p>Internet portal for monitoring and visualization of the PV system and user interface for the configuration of the Sunny Home Manager and the SMA radio-controlled sockets. Sunny Portal receives the data from the PV system and from the SMA radio-controlled sockets. The key PV system data can be accessed and clearly visualized in Sunny Portal at any time. Settings to be made in the Sunny Home Manager and the SMA radio-controlled sockets via Sunny Portal are transmitted to the Sunny Home Manager by Sunny Portal. The Sunny Home Manager transmits the settings to the SMA radio-controlled sockets.</p>
G	Internet
H	Router/network switch
I	Utility grid
K	Feed-in and purchased electricity meter
L	<p>SMA Energy Meter</p> <p>Measuring device which detects electrical measured values at the connection point and makes them available via Speedwire. The SMA Energy Meter is a feed-in and purchased electricity meter.</p>

Sunny Boy Smart Energy and Energy Meter

The Sunny Boy Smart Energy optimizes self-consumption in the household by by intermediate storage of excess PV energy by the Battery Pack.

The Sunny Boy Smart Energy receives the data from the connected energy meter and thus captures feed-in and purchased electricity. Based on this data, the Sunny Boy Smart Energy controls the charge and discharge of the Battery Pack. Via Webconnect, the Sunny Boy Smart Energy can transmit the operating data directly to Sunny Portal. In Sunny Portal, you can monitor the PV system and visualize the operating data.

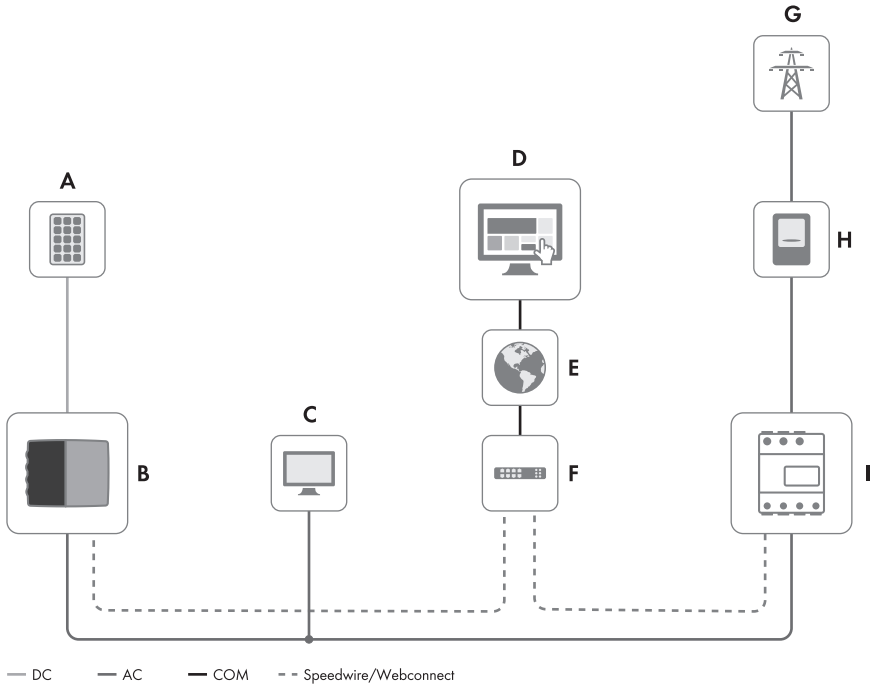

Figure 4: Overview of a system with Sunny Boy Smart Energy, Battery Pack and SMA Energy Meter (example)

Position	Designation
A	PV array
B	Inverter and Battery Pack
C	Load
D	Sunny Portal Internet portal for monitoring and visualization of the PV system. Sunny Portal receives the PV system data. The key PV system data can be accessed and clearly visualized in Sunny Portal at any time.
E	Internet

Position	Designation
F	Router/network switch
G	Utility grid
H	Feed-in and purchased electricity meter
I	SMA Energy Meter Measuring device which detects electrical measured values at the connection point and makes them available via Speedwire. The SMA Energy Meter is a net feed-in and purchased electricity meter.

5 Mounting

5.1 Requirements for Mounting

Requirements for the mounting location:

⚠ DANGER

Danger to life due to fire or explosion

Despite careful construction, electrical devices can cause fires.

- Do not mount the inverter and the Battery Pack in areas containing highly flammable materials or gases.
- Do not mount the inverter or the Battery Pack in a potentially explosive atmosphere.
- Do not mount the inverter or the Battery Pack in areas of high humidity (see Section 11 "Technical Data", page 57).

- The mounting location must not be outdoors.
- Mounting on a pillar or top-hat rail is not permitted.
- Mounting of the inverter and Battery Pack must take place using the supplied wall mounting bracket only.
- The mounting location must be inaccessible to children.
- A solid, flat support surface, e.g. concrete or masonry, must be available for mounting. When mounted on drywall or similar materials, the inverter emits audible vibrations during operation which could be perceived as annoying.
- The mounting location must be suitable for the weight and dimensions of the inverter and the Battery Pack (see Section 11 "Technical Data", page 57).
- The mounting location must not be exposed to direct solar irradiation.
- Climatic conditions must be met (see Section 11 "Technical Data", page 57).
- To ensure optimal operation of the inverter and the Battery Pack, the ambient temperature should be between +15°C and +30°C.
- The mounting location should be clear and safely accessible at all times without the need for any auxiliary equipment (such as scaffolding or lifting platforms). Non-fulfillment of these criteria may restrict servicing.

Dimensions for wall mounting:

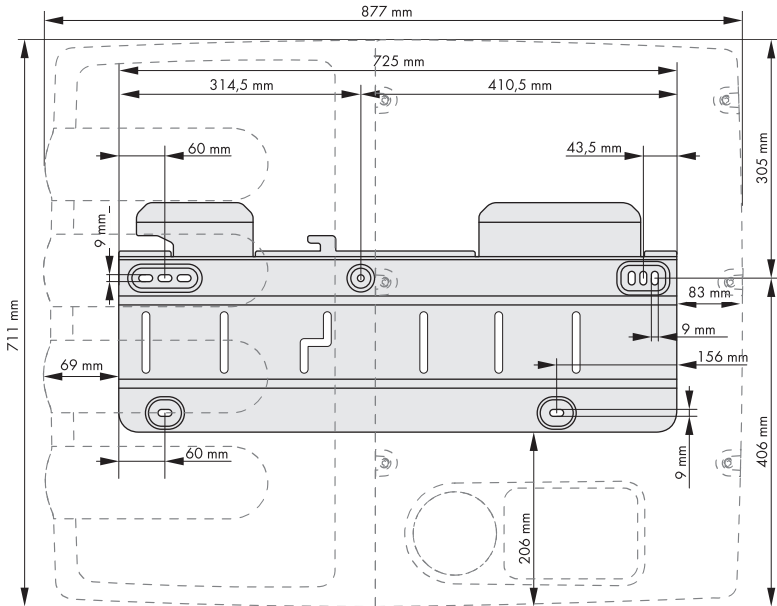

Figure 5: Dimensions of the wall mounting bracket

Recommended clearances:

Provided that the recommended clearances are observed, adequate heat dissipation will be ensured. This will prevent any reduction in the power of the inverter or the Battery Pack as a result of excessive temperature (details of temperature derating of the inverter can be found in the Technical Information "Temperature Derating" at www.SMA-Solar.com).

- Observe the recommended clearances to walls as well as to other inverters or objects.
- If multiple inverters are mounted in areas with high ambient temperatures, increase the clearances between the inverters and ensure sufficient fresh-air supply.

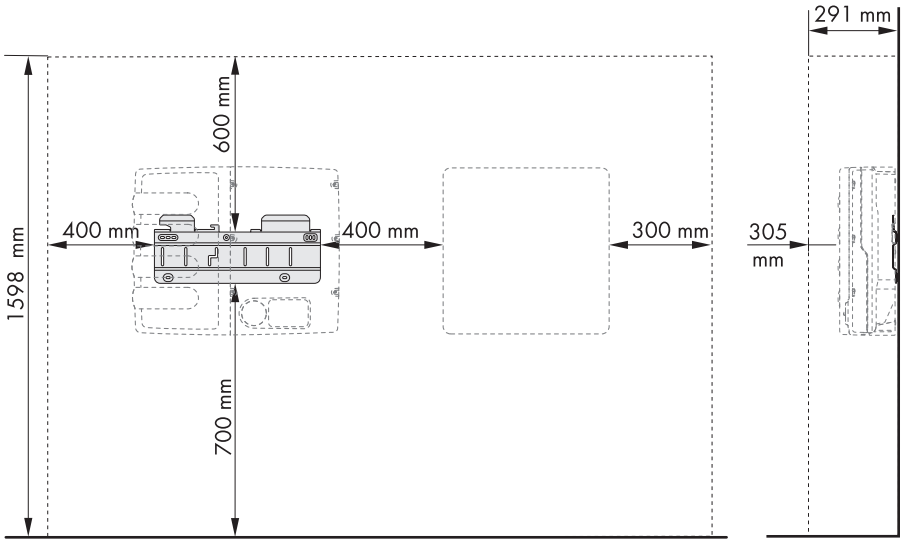

Figure 6: Recommended clearances

Permitted and prohibited mounting positions:

- The inverter must be mounted in one of the permitted positions. This will ensure that no moisture can penetrate the inverter.

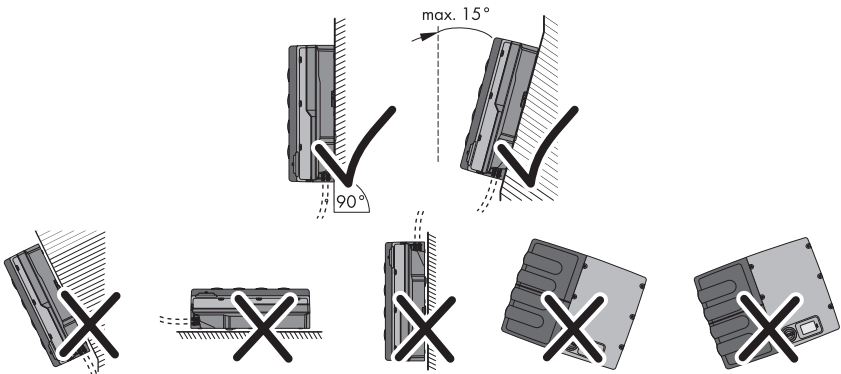

Figure 7: Permitted and prohibited mounting positions

5.2 Mounting the Inverter and Battery Pack

⚠ QUALIFIED PERSON

Additionally required material (not included in the scope of delivery):

- Five screws suitable for the support surface (diameter: at least 6 mm)
- Five washers suitable for the screws (outer diameter: at least 18 mm)
- If applicable, at least five screw anchors suitable for the support surface and the screws

⚠ CAUTION

Risk of injury through lifting or dropping the inverter or Battery Pack

The inverter and Battery Pack are heavy (see Section 11 "Technical Data", page 57). There is risk of injury if the inverter or Battery Pack is lifted incorrectly or dropped during transport or when attaching to or removing from the wall.

- Hold the inverter by the right-hand and left-hand recessed grips, and lift and transport it to the mounting position horizontally.
- Lift and transport the Battery Pack by the lateral handles.

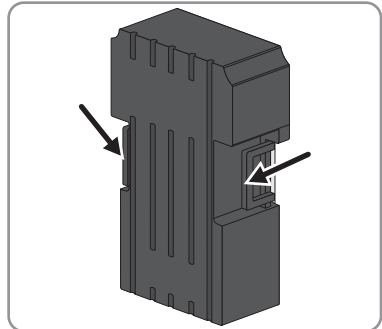
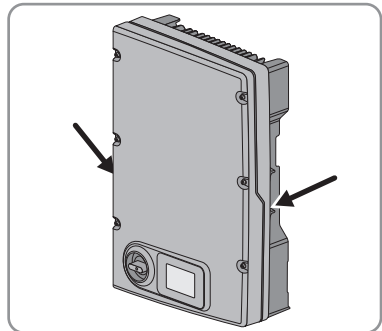

⚠ CAUTION

Risk of injury due to sharp edges on the wall mounting bracket

- Wear personal protective equipment such as safety gloves.

Procedure:

1. Ensure that no cables are laid in the wall which could be damaged when drilling holes.

2. **⚠ CAUTION**

Risk of injury when drilling through the wall mounting bracket

If you drill through the wall mounting bracket, it could rotate and inflict cuts.

- Do not drill through the wall mounting bracket.

3. Align the wall mounting bracket horizontally on the wall and mark the position of the five drill holes.

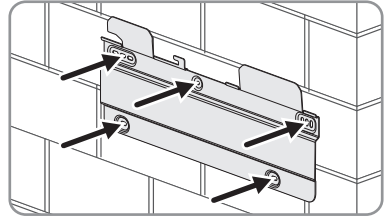

4. Set the wall mounting bracket aside and drill the marked holes.

5. Insert screw anchors into the drill holes if necessary.

6. Fasten the wall mounting bracket horizontally to the wall using five screws and washers.

7. Hook the inverter into the right-hand side of the wall mounting bracket. The tabs of the wall mounting bracket into which the inverter is hooked should be located approximately in the center of the inverter.

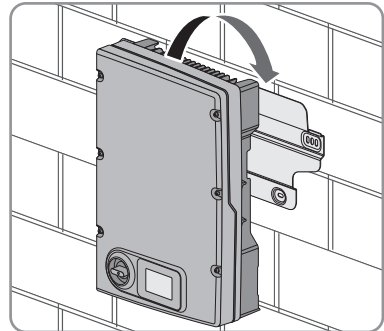

8. Ensure that the inverter is securely in place.

9. Hook the Battery Pack into the left-hand side of the wall mounting bracket. The handle on the right-hand side of the Battery Pack must end up flush with the hook-in position marked on the wall mounting bracket.

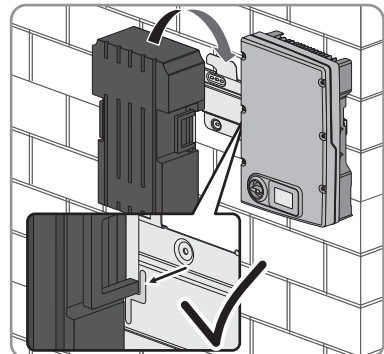

6 Electrical Connection

6.1 Overview of the Connection Areas

6.1.1 View from Below

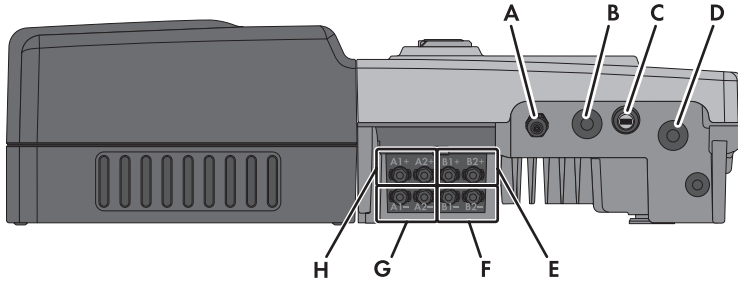

Figure 8: Connection areas and enclosure openings at the bottom of the inverter

Position	Designation
A	Cable gland M20x1.5 for the connection to the multifunction relay
B	Enclosure opening with filler plug for the data cable
C	USB pin connector for service purposes (e.g., firmware update)
D	Enclosure opening for the AC cable
E	Positive DC connectors, input B
F	Negative DC connectors, input B
G	Negative DC connectors, input A
H	Positive DC connectors, input A

6.1.2 Interior View

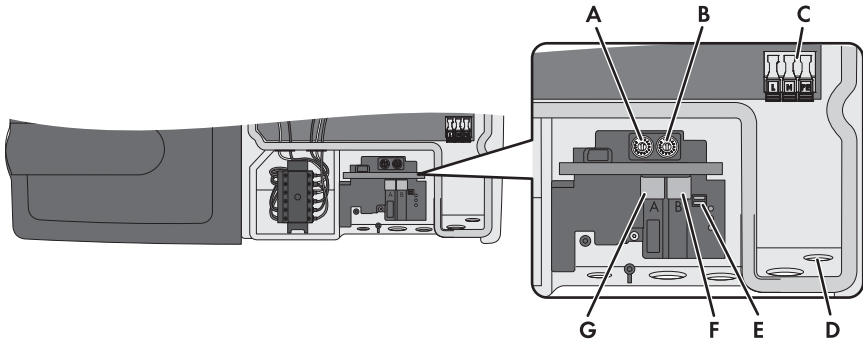

Figure 9: Connection areas in the interior of the inverter

Position	Designation
A	Rotary switch A for setting the country data set
B	Rotary switch B for setting the display language
C	Connecting terminal plate for the AC cable
D	Pressure equalizing membrane
E	Switch for temporarily changing the display language to English (for service purposes)
F	Network port B
G	Network port A

6.2 AC Connection

6.2.1 Requirements for the AC Connection

Cable requirements:

- External diameter: 12 mm to 21 mm
- Maximum conductor cross-section: 10 mm²
- Insulation stripping length: 18 mm
- The cable must be dimensioned in accordance with the local and national directives for the dimensioning of cables. The requirements for the minimum wire size derive from these directives. Examples of factors influencing cable dimensioning are: nominal AC current, type of cable, routing method, cable bundling, ambient temperature and maximum desired line losses (for calculation of line losses, see design software Sunny Design from software version 2.0 at www.SMA-Solar.com).

Load-break switch and cable protection:**NOTICE****Damage to the inverter due to the use of screw-type fuses as load-break switches**

Screw-type fuses (e.g. DIAZED fuse or NEOZED fuse) are not load-break switches.

- Do not use screw-type fuses as load-break switches.
 - Use a load-break switch or circuit breaker as a load disconnection unit (for information and design examples, see the Technical Information "Circuit Breaker" at www.SMA-Solar.com).
- In PV systems with multiple inverters, protect each inverter with a separate circuit breaker. Make sure to observe the maximum permissible fuse protection (see Section 11 "Technical Data", page 57). This will prevent residual voltage being present at the corresponding cable after disconnection.
- Loads installed between the inverter and the circuit breaker must be fused separately.

Grounding conductor monitoring

The inverter is equipped with a grounding conductor monitoring device. This grounding conductor monitoring device detects when there is no grounding conductor connected and disconnects the inverter from the utility grid if this is the case. Depending on the installation site and grid configuration, it may be advisable to deactivate the grounding conductor monitoring. This is necessary, for example, in an IT system if there is no neutral conductor present and you intend to install the inverter between two line conductors. If you are uncertain about this, contact your grid operator or SMA Solar Technology AG.

- Grounding conductor monitoring must be deactivated after initial start-up depending on the grid configuration (see Section 8.10, page 49).

i Safety in accordance with IEC 62109 when the grounding conductor monitoring is deactivated

In order to guarantee safety in accordance with IEC 62109 when the grounding conductor monitoring is deactivated, one of the following measures must be taken:

- Connect a grounding conductor made of copper wire with a cross-section of at least 10 mm² to the connecting terminal plate for the AC cable.
- Connect additional grounding with the same cross-section as the connected grounding conductor to the connecting terminal plate for the AC cable (see Section 6.2.3 "Connecting Additional Grounding", page 31). This prevents touch current if the grounding conductor at the connecting terminal plate for the AC cable fails.

i Connection of additional grounding

In some countries, additional grounding is generally required. In each case, observe the locally applicable regulations.

6.2.2 Connecting the Inverter to the Utility Grid

⚠ QUALIFIED PERSON

Requirements:

- The connection requirements of the grid operator must be met.
- The grid voltage must be in the permissible range. The exact operating range of the inverter is specified in the operating parameters.

Procedure:

1. Disconnect the circuit breaker and secure it against reconnection.
2. Ensure that the DC load-break switch is turned to position **O**.
3. Unscrew all the screws of the enclosure lid using an Allen key (AF 5) and remove the enclosure lid. Ensure that the conical spring washers are retained.
4. Remove the adhesive tape from the enclosure opening for the AC cable.
5. Attach the cable gland M32x1.5 to the enclosure opening using a counter nut. Make sure that the pressure equalizing membrane is not damaged.
6. Unscrew the swivel nut from the cable gland and lead the AC cable through.
7. If the outer diameter of the cable is between 15 mm and 21 mm, remove the inner sealing ring from the cable gland.
8. Push the safety levers of the AC connecting terminal plate right up to the stop.
9. Route the AC cable into the inverter through the cable gland. Make sure that the pressure equalizing membrane is not damaged.
10. Dismantle the AC cable.
11. Shorten L and N by 5 mm each.
12. Strip the insulation of L, N and PE by 18 mm.

13. ⚠ CAUTION

Risk of fire if two conductors are connected to one terminal

If you connect two conductors to a terminal, a fire can occur due to a bad electrical connection.

- Never connect more than one conductor per terminal.

14. Connect PE, N and L to the connecting terminal plate for the AC cable in accordance with the labeling and push the locking levers down.

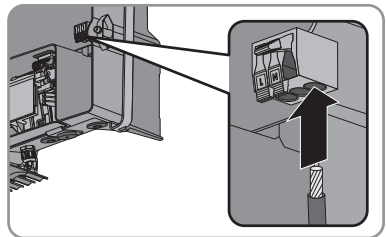

15. Make sure that all conductors are securely in place.
16. Screw the swivel nut onto the cable gland.

6.2.3 Connecting Additional Grounding

⚠ QUALIFIED PERSON

If local requirements stipulate the connection of additional grounding or equipotential bonding, you must connect additional grounding to the inverter. This prevents touch current if the grounding conductor at the connecting terminal plate for the AC cable fails.

Cable requirement:

- Grounding cable cross-section: max. 10 mm²

Procedure:

1. Strip the grounding cable insulation. If you are using a grounding cable with double insulation, strip the outer insulation by 120 mm.
2. Release the screw using an Allen key (AF 5), until the grounding cable can be led under the clamping bracket.

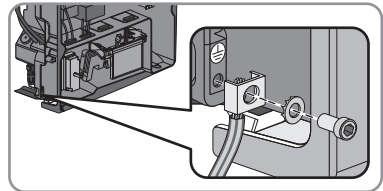

3. Feed the grounding cable under the clamping bracket. Position the grounding conductor on the left-hand side.
4. Tighten the clamping bracket with the screw and conical spring washer (torque: 6 Nm). The teeth of the conical spring washer must face the clamping bracket.

6.3 Connecting the Network and SMA Energy Meter

⚠ QUALIFIED PERSON

Connection options:

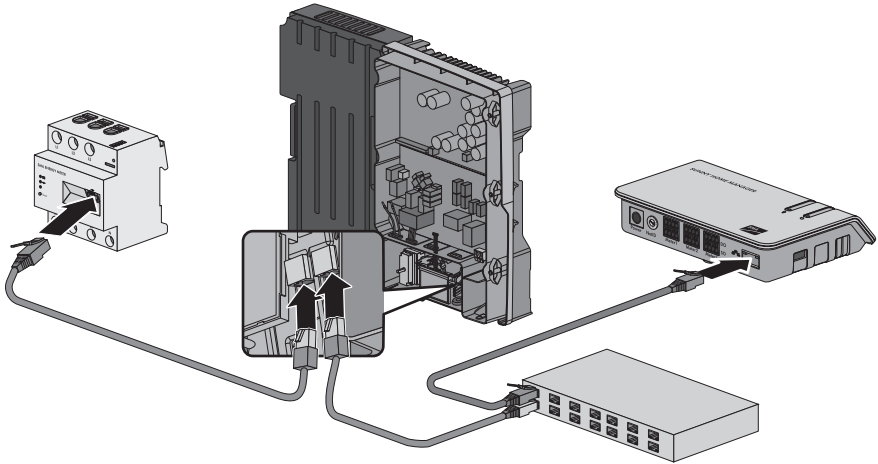

Figure 10: Connection option: Integrated Storage System (example)

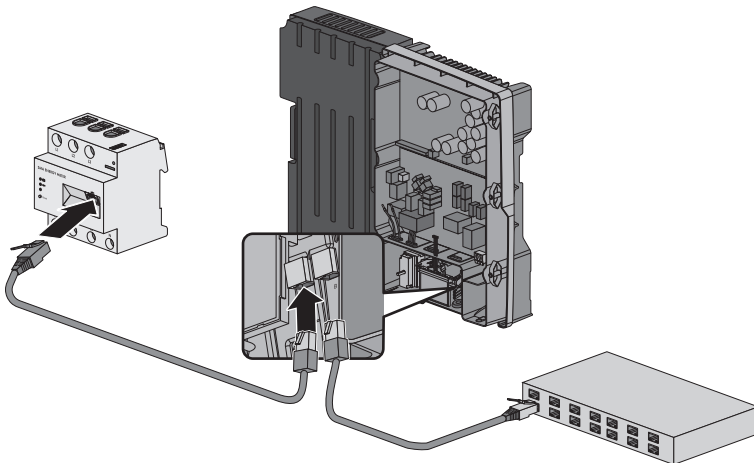

Figure 11: Connection option: Sunny Boy Smart Energy and SMA Energy Meter (example)

Required material (not included in the scope of delivery):

- Two network cables

Cable requirements:

The cable length and quality affect the quality of the signal. Observe the following cable requirements.

- Cable type: 100BaseTx
SMA Solar Technology AG recommends cable type "SMA COMCAB-OUTxxx" for outdoor use and cable type "SMA COMCAB-INxxx" for indoor use, available in lengths xxx = 100 m, 200 m, 500 m, 1,000 m
- Shielding: S-FTP or S-STP
- Plug type: RJ45 of Cat5, Cat5e, Cat6, Cat6a
- Number of insulated conductor pairs and insulated conductor cross-section: at least 2 x 2 x 0.22 mm²
- Maximum cable length between two nodes with patch cable: 50 m
- Maximum cable length between two nodes with installation cable: 100 m
- UV-resistant for outdoor use

i Interference in data transmission due to unshielded energy cables

If unshielded power cables are used, they generate an electromagnetic field during operation which may induce interference in network cables during data transmission.

- When laying network cables, observe the following minimum clearances to unshielded energy cables:
 - For installation without separating strip: at least 200 mm
 - For installation with aluminum separating strip: at least 100 mm
 - For installation with steel separating strip: at least 50 mm

i SMA Energy Meter and inverter must be connected with cables

- In order to ensure data transmission from the SMA Energy Meter to the inverter, connect the SMA Energy Meter to the inverter with cables. Use a network cable which corresponds to the specified cable requirements.

Procedure:

1.  **DANGER**

Danger to life due to high voltages

- Ensure that the inverter is disconnected from all voltage sources and that the enclosure lid is removed (see Section 10, page 54).
2. Flip the display up until it snaps into place.
 3. Press the filler plug out of the left-hand enclosure opening for data cables.
 4. Use the counter nut to fasten the cable gland M32x1.5 to the enclosure opening with a one-hole or two-hole cable support sleeve.
 5. Unscrew the swivel nut from the cable gland.
 6. Press the cable support sleeve out of the cable gland from the inside.
 7. Lead the network cable through the swivel nut of the cable gland.
 8. Remove one filler plug from the cable support sleeve.

9. Route each network cable through a separate opening in the cable support sleeve.

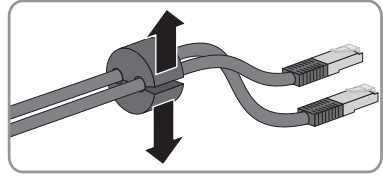

10. Lead the network cables through the cable gland M32x1.5 to the network ports in the inverter. Press the cable support sleeve firmly into the cable gland.

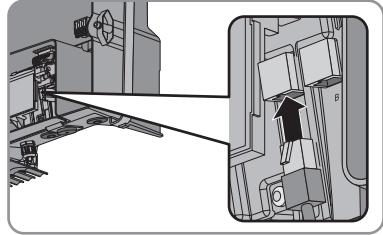

11. Insert the network cables into the network ports **A** and **B** in the inverter. The assignment of the network cables to the pin connectors is not relevant, as the pin connectors constitute a switch function.
12. Connect the ends of the network cables to the SMA Energy Meter and the router/network switch.
13. Screw the swivel nut onto the cable gland.
14. Flip the display down until it snaps into place.

6.4 DC Connection

6.4.1 Requirements for the DC Connection

Requirements for the PV modules per input:

- All PV modules must be of the same type.
- The same number of series-connected PV modules must be connected to each string.
- All PV modules must be aligned identically.
- All PV modules must have the same tilt angle.
- The maximum input current per string must be maintained and must not exceed the through-fault current of the DC connectors (see Section 1.1 "Technical Data", page 57).
- The thresholds for the input voltage and the input current of the inverter must be adhered to (see Section 1.1 "Technical Data", page 57).
- On the coldest day based on statistical records, the open-circuit voltage of the PV array must never exceed the maximum input voltage of the inverter.
- The positive connection cables of the PV modules must be fitted with the positive DC connectors (for information on assembling DC connectors, see the DC connector installation manual).
- The negative connection cables of the PV modules must be fitted with the negative DC connectors (for information on assembling DC connectors, see the DC connector installation manual).

i Use of Y adapters for parallel connection of strings

The Y adapters must not be used to interrupt the DC circuit.

- Do not use the Y adapters in the immediate vicinity of the inverter. The adapters must not be visible or freely accessible.
- In order to interrupt the DC circuit, always disconnect the inverter as described in this document (see Section 10, page 54).

6.4.2 Connecting the PV Array

⚠ QUALIFIED PERSON

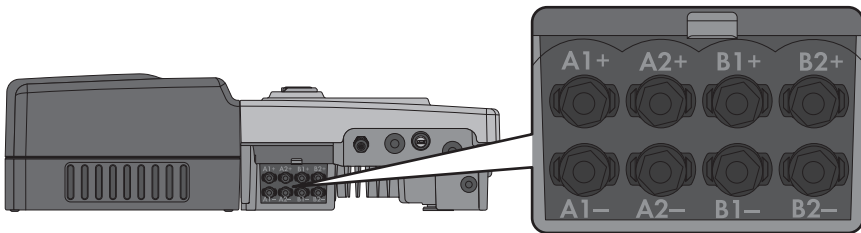
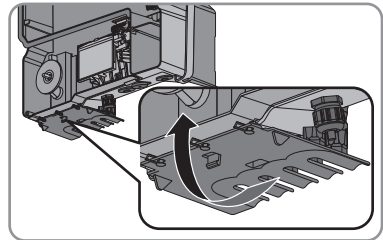

Figure 12: Overview of the DC inputs on the inverter

1. Ensure that the circuit breaker is switched off and that it cannot be accidentally reconnected.
2. If the enclosure lid is mounted, remove it as follows:
 - Turn the DC load-break switch towards **OFF** until it snaps into place at position **O**.
 - Unscrew all the screws of the enclosure lid using an Allen key (AF 5) and remove the enclosure lid. Ensure that the conical spring washers are not lost.
3. Ensure that no ground fault is present.
4. Flip the DC contact protection up and press firmly until it snaps into place.



5. Connect the assembled DC connectors to the inverter. Route the connection cables in the corresponding bracket.
 - The DC connectors snap audibly into place.

6. **NOTICE****Damage to the inverter due to moisture ingress**

The inverter is only properly sealed when all unused DC inputs are closed with DC connectors and sealing plugs.

- Do not insert the sealing plugs directly into the DC inputs on the inverter.
- For unused DC connectors, push down the clamping bracket and push the swivel nut up to the thread.

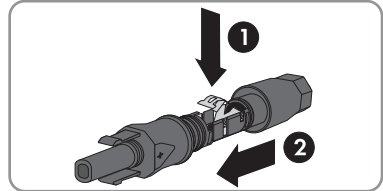

- Insert the sealing plug into the DC connector.

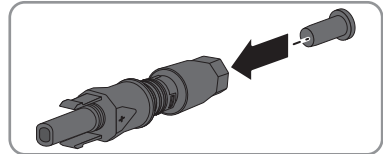

- Tighten the DC connector (torque: 2 Nm).

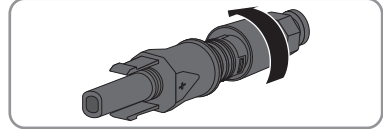

- Insert the DC connectors with sealing plugs into the corresponding DC inputs on the inverter.

The DC connectors snap audibly into place.

7. Ensure that all DC connectors are securely in place.

8. Flip the DC contact protection down until it snaps into place. Route the connection cables in the corresponding bracket.

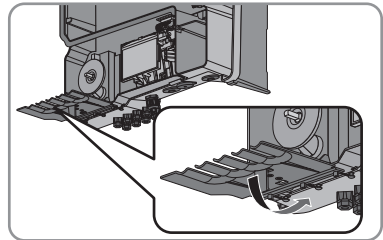

6.5 Connecting the Inverter and the Battery Pack

⚠ QUALIFIED PERSON

1. ⚠ DANGER

Danger to life due to high voltages

- Ensure that the inverter is disconnected from all voltage sources and that the enclosure lid is removed (see Section 10, page 54).
2. Remove the protective cap from the pin connector for the power cable and retain for the event of decommissioning of the Battery Pack.
 3. Release the data cable and the power cable from the bracket on the inverter and remove the adhesive tape from the plugs.
 4. Insert the power cable plug in the pin connector for the power cable making sure that the white markings on the plug and the pin connector are aligned. Turn the plug until it snaps into place.

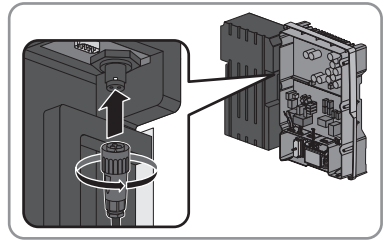

5. Ensure that the plug is securely in place.
6. Remove the protective cap from the D-sub plug of the Battery Pack and retain for the event of decommissioning of the Battery Pack.
7. Connect the data cable for communication between the inverter and the Battery Pack to the D-sub plug on the Battery Pack.

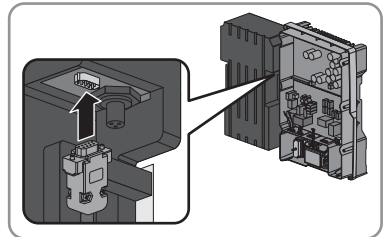

- The plug snaps into place.

8. **⚠ CAUTION**

Danger of crushing if the Battery Pack is moved to its end position on the wall mounting bracket with a jerk

- Grip the Battery Pack by the handles and push it to the right as far as it will go.

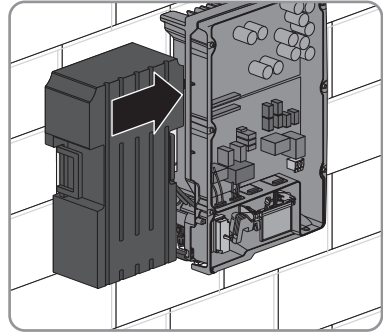

9. Position the protective cover over the Battery Pack. The tabs on the right-hand side of the protective cover must engage with the guides on the left of the inverter enclosure. Finally, press the left side of the protective cover down onto the Battery Pack until it snaps into place.

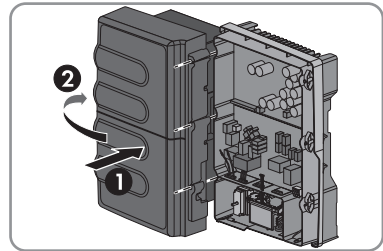

7 Commissioning

7.1 Procedure

QUALIFIED PERSON

Before you can commission the inverter, you must check various settings and make changes if necessary. This section describes the procedure for commissioning and gives an overview of the steps you must always perform in the prescribed order.

Procedure	See
1. Check which country data set the inverter is set to.	Supplementary sheet with the default settings, type label or display
2. If the country data set is not set correctly for your country or your purpose, adjust to the required country data set and corresponding display language.	Section 7.2, page 39
3. Commission the inverter and start a self-test, if required.	Section 7.3, page 40 and Section 7.4, page 41

7.2 Configuring the Country Data Set

QUALIFIED PERSON

A display language is assigned to every country data set. Set the country data set appropriate for your country or purpose, with the corresponding display language, within the first ten feed-in hours via the rotary switches in the inverter. After the first ten feed-in hours, the country data set can only be changed by means of a communication product.

If the display language of the country data set does not match the required language, you can change it after commissioning (see Section 8.2, page 44).

The country data set must be set correctly.

If you select a country data set which is not valid for your country and purpose, it can cause a disturbance in the PV system and lead to problems with the grid operator. When selecting the country data set, you must always observe the locally applicable standards and directives as well as the properties of the PV system (e.g. PV system size, grid-connection point).

- If you are not sure which country data set is valid for your country or purpose, contact your grid operator for information on which country data set is to be configured.

Procedure:

1. Determine the rotary switch position for your country and purpose. To do this, consult the Technical Information "Overview of the Rotary Switch Settings" at www.SMA-Solar.com.

2. **⚠ DANGER**

Danger to life due to high voltages

- Ensure that the inverter is disconnected from all voltage sources and that the enclosure lid is removed (see Section 10, page 54).

3. Set the rotary switches **A** and **B** to the required position using a flat-blade screwdriver (blade width: 2.5 mm).

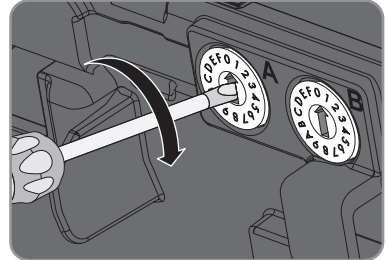

- The inverter will adopt the setting after commissioning. This can take up to five minutes.

7.3 Commissioning the Inverter

⚠ QUALIFIED PERSON**Requirements:**

- The inverter and the Battery Pack must be correctly mounted.
- The circuit breaker must be correctly rated.
- All cables must be completely and correctly connected.
- Unused DC inputs must be sealed using the corresponding DC connectors and sealing plugs.
- The country data set must be set correctly for the country or the purpose.
- The Battery Pack must have been pushed as far as possible to the right on the wall mounting bracket and the protective cover must be over the Battery Pack.
- The inverter must be connected to the network.
- The inverter must be connected to the SMA Energy Meter or to another suitable energy meter.

Procedure:

1. Ensure that the DC load-break switch is turned to position **OFF**. This makes it possible to fit the enclosure lid to the enclosure.
2. Attach the enclosure lid as follows:

- Fit one conical spring washer to each screw. The grooved side of the conical spring washer must point to the screw head.

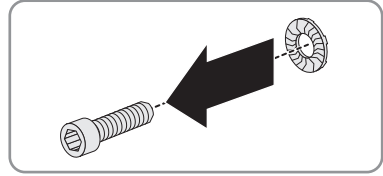

- Position the enclosure lid with the six screws on the enclosure and tighten all screws diagonally to each other using an Allen key (AF 5) (torque: 6 Nm \pm 0.5 Nm).
3. Switch on the circuit breaker.
 4. Turn the DC load-break switch towards **ON** until it snaps into place at position I.
- All three LEDs start to glow and the start-up phase begins. The start-up phase may take several minutes.

i **Self-test in accordance with CEI 0-21 during commissioning (applies to Italy only)**

The Italian standard prescribes that an inverter can only operate on the utility grid after the disconnection times for overvoltage, undervoltage, minimum frequency and maximum frequency have been checked.

- If the country data set is configured to **CEI0-21 Int** or **CEI 0-21 internal**, start the self-test (see Section 7.4.1, page 41).
- The green LED is glowing and the display alternates between the firmware version, the serial number of the inverter, the IP address, the subnet mask, the serial number of the Battery Pack, the configured country data set and the display language.
- The green LED is flashing?
Possible cause of error: the DC input voltage is still too low or the inverter is monitoring the utility grid.
- Once the DC input voltage is sufficiently high and the grid connection conditions are met, the inverter will start operation.
- The red LED is glowing and an error message and event number appear in the display?
- Rectify the error (see service manual at www.SMA-Solar.com).

7.4 Self-Test in Accordance with CEI 0-21 for PV Systems ≤ 6 kW

7.4.1 Starting the Self-Test

⚠ QUALIFIED PERSON

i **The self-test only applies to inverters that are configured with the country data set CEI 0-21 Int or CEI 0-21 internal.**

The self-test is only valid for inverters licensed for Italy and configured with the country data set **CEI 0-21 Int** or **CEI 0-21 internal**.

If the inverter is configured to the country data set **CEI 0-21 Ext** or **CEI 0-21 external**, no self-test is required.

The self-test is only required for inverters to be commissioned in Italy. The Italian standard requires that all inverters feeding into the utility grid are equipped with a self-test function in accordance with CEI 0-21. During the self-test, the inverter will consecutively check the reaction times for overvoltage, undervoltage, maximum frequency and minimum frequency.

The self-test changes the upper and lower disconnection values for each protective function on a linear basis for frequency monitoring and voltage monitoring. As soon as the measured value exceeds the permitted disconnection threshold, the inverter disconnects from the utility grid. In this way, the inverter determines the reaction time and checks itself.

After the self-test has been completed, the inverter automatically switches back to feed-in operation, resets the original shutdown conditions and connects to the utility grid. The test takes approximately three minutes.

Requirements:

- Configured country data set: **CEI 0-21 Int** or **CEI 0-21 internal** or amended country data set **trimmed** or **Special setting** based on one of the country data sets mentioned above.
- A report for entering the test results according to CEI 0-21 must be available.
- The inverter must be in operation and in the start-up phase.

Procedure:

1. As soon as the configured country data set appears in the display, tap once on the display within ten seconds.
 - A message informing you that the self-test has started is shown in the display: **Avvio Autotest**.
 - The message **Avvio Autotest** is not shown in the display?
 - The ten seconds have elapsed so the self-test cannot start..
 - Restart the self-test (see Section 7.4.2, page 43).
2. Tap on the display within 20 seconds and enter the subsequent test results into the test report.
 - The self-test starts.
 - The inverter displays the results of the individual tests for overvoltage, undervoltage, maximum frequency and minimum frequency. The results are displayed three times in succession for ten seconds each.
 - Useful hint: If you want to have the next result displayed without waiting ten seconds, tap twice on the enclosure lid.
 - The information **Autotest interroto** is shown in the display?
 - The self-test was cancelled due to an unexpected disconnection condition or the DC voltage is too low to continue grid feed-in.
 - Restart the self-test (see Section 7.4.2, page 43).

Example: Display messages for overvoltage test

- Name of the test: **Autotest (59.S1) 240.00V**
 - Disconnection value: **Valore di soglia con 230.00V**
 - Normative value: **Va. taratura 253.00V**
 - Disconnection time: **Tempo die intervento 0.02 s**
 - Current line voltage: **Tensione di rete Val.eff.: 229.80V**
-

7.4.2 Restarting the Self-Test

QUALIFIED PERSON

1. Disconnect the circuit breaker and secure it against reconnection.
2. If the multi-function relay is used, switch off the load supply voltage, if necessary.
3. Turn the DC load-break switch towards **OFF** until it snaps into place at position **O**.
4. Wait five minutes.
5. Turn the DC load-break switch towards **ON** until it snaps into place at position **I**.
6. Recommission the inverter.
 - The inverter is back in the start-up phase and you can start the self-test (see Section 7.4.1, page 41).

8 Configuration

8.1 Procedure

QUALIFIED PERSON

Once you have commissioned the inverter, you may have to adjust various settings via the rotary switches in the inverter or via a communication product. This section describes the procedure for configuration and gives an overview of the steps you must perform in the prescribed order.

Procedure	See
1. If the display language is not set correctly, adjust the settings.	Section 8.2, page 44
2. Integrate the inverter into the network.	Section 8.3, page 45
3. To monitor the PV system and visualize PV system data, create a Sunny Portal system.	Section 8.4, page 46
4. To enable configuration of inverter operating parameters, download Sunny Explorer with minimum software version 1.07 to your computer and create the system in Sunny Explorer, or add the inverter to an existing system.	Manual of the Sunny Explorer at www.SMA-Solar.com
5. Set the PV system password and PV system time with Sunny Explorer or Sunny Portal.	Manual of the respective communication product at www.SMA-Solar.com
6. If it is likely that the battery cannot be charged for a certain time during the year, e.g., in winter due to snow-covered PV modules, set the lower battery charge limit.	Section 8.6, page 47
7. Set the active power limit at the grid-connection point.	Section 8.7, page 48
8. Set the active power limitation in case of PV system control failure.	Section 8.8, page 48
9. Ensure that there is communication with the purchased electricity meter.	Section 8.9, page 49
10. If necessary, deactivate grounding conductor monitoring.	Section 8.10, page 49
11. For partially shaded PV modules and depending on the given shading situation, you should set the interval at which the inverter optimizes the MPP of the PV system.	Section 8.11, page 50

8.2 Changing the Display Language

QUALIFIED PERSON

If the language for the country data set is not the language you want to use, you can change the display language as follows:

Procedure:1. **⚠ DANGER****Danger to life due to high voltages**

- Disconnect the inverter from all voltage sources and open the enclosure lid (see Section 10, page 54).
2. Determine the rotary switch setting for the desired display language. To do this, consult the Technical Information "Overview of the Rotary Switch Settings" at www.SMA-Solar.com.
 3. Set the rotary switch **A** to **0** using a flat-blade screwdriver (blade width: 2.5 mm). This ensures that the selected data country set remains unchanged.

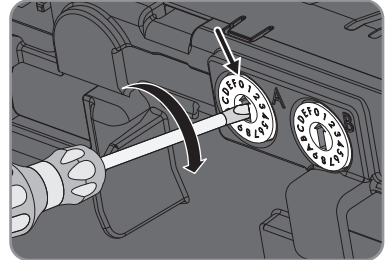

4. Set the rotary switch **B** to the required language using a flat-blade screwdriver (blade width: 2.5 mm).
 5. Recommission the inverter (see service manual at www.SMA-Solar.com).
- The inverter adopts the settings after commissioning. This can take up to five minutes.

8.3 Integrating the Inverter into the Network

If the router supports DHCP and DHCP is enabled, the inverter will automatically be integrated into the network. You will not need to carry out network configuration.

If the router does not support DHCP, automatic network configuration will not be possible and you will need to use SMA Connection Assist to integrate the inverter into the network.

Requirements:

- The inverter and the SMA Energy Meter must be connected to the same Internet-enabled network.
- The inverter must be in operation.
- A computer with Internet connection is required.

Procedure:

- Integrate the inverter into the network by means of the SMA Connection Assist. Download the SMA Connection Assist and install it on the computer (see www.SMA-Solar.com).

8.4 Creating a Sunny Portal System

i Registration data for detecting the inverter in Sunny Portal

To detect the inverter in Sunny Portal, you will need the registration data. The registration data, PIC and RID are to be found on the supplementary sheet with information on SMA Speedwire/Webconnect or on the additional label on the inverter.

- Keep the registration data in readiness.

To monitor the PV system or visualize PV system data in Sunny Portal, you will need to register in Sunny Portal as a user and create the system in Sunny Portal. Depending on the structure of the systems, you may need to create different systems in Sunny Portal.

Procedure:

- If you are operating an Integrated Storage System, create a Sunny Home Manager system in Sunny Portal.
- If you are operating the Sunny Boy Smart Energy and the SMA Energy Meter without Sunny Home Manager, create a Webconnect system in Sunny Portal.

Creating a Sunny Home Manager System in Sunny Portal

1. If you are not registered as a user in Sunny Portal, use the PV System Setup Assistant to register (see user manual "Sunny Home Manager in Sunny Portal" at www.SunnyPortal.com).
2. If you are already registered as a user in Sunny Portal, log in as an existing user.
3. Create a Sunny Home Manager system in Sunny Portal or add the inverter and the SMA Energy Meter to an existing Sunny Home Manager system (see the User Manual "Sunny Home Manager in Sunny Portal" at www.SunnyPortal.com). Do not exceed the maximum number of devices permitted in a Sunny Home Manager system.
4. Configure the energy meter (see the User Manual "Sunny Home Manager in Sunny Portal" at www.SunnyPortal.com).

Creating a Webconnect System in Sunny Portal

1. If you are not registered as a user in Sunny Portal, use the PV System Setup Assistant to register (see user manual "Webconnect Systems in Sunny Portal" at www.SunnyPortal.com).
2. If you are already registered as a user in Sunny Portal, log in as an existing user.
3. Create a Webconnect system in Sunny Portal or add the inverter and the SMA Energy Meter to an existing Webconnect system (see the User Manual "Webconnect Systems in Sunny Portal" at www.SunnyPortal.com). Do not exceed the maximum number of devices permitted in a Webconnect system.

8.5 Changing Operating Parameters

This section describes the basic procedure for changing operating parameters. Always change operating parameters as described in this section. Some function-sensitive parameters can only be viewed and changed by qualified persons (for further information on changing parameters, refer to the Sunny Explorer manual).

The operating parameters of the inverter are set to certain values by default. To optimize the performance of the inverter, you can change the operating parameters using the Sunny Explorer software. You can read off the default settings in Sunny Explorer.

Requirements:

- A computer with an Ethernet interface must be available.
- Sunny Explorer with minimum software version 1.07 must be available and installed on the computer.
- The inverter must be registered in the communication product.
- The changes to the grid-relevant operating parameters must be approved by the responsible grid operator.
- When changing grid-relevant parameters, the SMA Grid Guard code must be available (see Certificate "Order Form for the SMA Grid Guard Code" at www.SMA-Solar.com).

Procedure:

1. Access Sunny Explorer and log in as an installer or user.
2. If required, enter the SMA Grid Guard code.
3. Select and set the required parameter.
4. Save settings.

8.6 Setting the Lower Battery Charge Limit

QUALIFIED PERSON

You will need to set the lower battery charge limit if it is likely that the battery cannot be charged for a certain time, e.g. in winter due to snow-covered PV modules. This will help to protect the battery.

Procedure:

- Select the parameter **Lower battery charge limit** and set the value as follows:

Expected period in which the battery cannot be charged	Lower battery charge limit
≤ 2 months	0%
2 to 3 months	3%
3 to 4 months	5%
4 to 5 months	6%
5 to 6 months	8%
≥ 6 months	16%

8.7 Setting the Active Power Limit at the Grid-Connection Point

QUALIFIED PERSON

You will only need to set the active power limit at the grid-connection point in systems with Sunny Boy Smart Energy and SMA Energy Meter. This will ensure that the inverter always feeds the maximum permissible PV power into the utility grid.

If you are operating an Integrated Storage System and have created a Sunny Home Manager system in Sunny Portal, the active power limit will already have been detected at the grid-connection point and this action will no longer be required.

The basic procedure for changing operating parameters is explained in another section (see Section 8.5, page 46).

Requirement:

- The total aggregate active power limit of all inverters at the grid-connection point must be known.

Default setting:

- SB 3600SE-10: 3,680 W
- SB 5000SE-10: 4,600 W

Procedure:

- Select the parameter **Avg. eff. power lim. grid conn. pt.** and set the total aggregate active power limit of all inverters present in the PV system.

8.8 Setting the Active Power Limitation in case of PV System Control Failure

QUALIFIED PERSON

You will need to set the active power limit in case of PV system control failure if you are operating an Integrated Storage System and the external active power limitation of the inverter is controlled by the Sunny Home Manager.

By setting the active power limitation in case of PV system control failure, you ensure that the inverter will still feed the maximum permissible PV power into the utility grid, even if communication between inverter and Sunny Home Manager has failed.

The basic procedure for changing operating parameters is explained in another section (see Section 8.5, page 46).

Requirements:

- The firmware version of the inverter must be at least 2.4.0.R.
- The total installed PV power must be known.

Default setting:

- SB 3600SE-10: 100%
- SB 5000SE-10: 100%

Procedure:

1. Ensure that the firmware version of the inverter is at least 2.4.0.R. If necessary, carry out a firmware update.
2. Select the parameter **Fallback act power lmt P in % of WMax for absent act power lmt** and set the required percentage.
3. Select the parameter **Operating mode for absent plant control** and set to **Use fallback setting**.

8.9 Ensuring Communication with the Purchased Electricity Meter

QUALIFIED PERSON

Communication with the purchased electricity meter must only be ensured for a system with Sunny Boy Smart Energy and SMA Energy Meter. If you are operating an Integrated Storage System and have created a Sunny Home Manager system in Sunny Portal, this action will not be required.

The basic procedure for changing operating parameters is explained in another section (see Section 8.5, page 46).

Procedure:

- Check whether the parameter **Speedwire meter status** is showing **Ok**.
If the parameter is showing **Ok**, the inverter has detected the purchased electricity meter and set up communication.
If the parameter is not showing **Ok**, the inverter has not detected the purchased electricity meter. The purchased electricity meter must be detected.
 - Select the parameter **Speedwire meter serial no.** and enter the serial number of the purchased electricity meter.

8.10 Deactivating Grounding Conductor Monitoring

QUALIFIED PERSON

If the inverter is to be installed in an IT network or another grid configuration in which deactivation of the grounding conductor monitoring is required, deactivate the grounding conductor monitoring as follows.

The basic procedure for changing operating parameters is explained in another section (see Section 8.5, page 46).

Procedure:

- Set the parameter **PE connection monitoring** or **PEOpnMon** to **Aus** or **Off**.

8.1.1 Setting SMA OptiTrac Global Peak

QUALIFIED PERSON

For partially shaded PV modules, you should set the interval at which the inverter is to optimize the MPP of the PV system.

The basic procedure for changing operating parameters is explained in another section (see Section 8.5 "Changing Operating Parameters", page 46).

Procedure:

- Select the parameter **Cycle time of the OptiTrac Global Peak algorithm** or **MPPShdw.CycTms** and set the required time interval. The ideal time interval is usually six minutes. This value should only be increased if the shading situation changes extremely slowly.
- The inverter optimizes the MPP of the PV system at the predetermined time interval.

9 Operation

9.1 LED Signals

The LEDs indicate the operating state of the inverter.

LED	Status	Explanation
Green LED	glowing	Operation
	flashing	The requirements for the connection to the utility grid have not been met.
Red LED	glowing	Error The red LED indicates an error (for troubleshooting, see service manual at www.SMA-Solar.com).
Blue LED	-	No function

9.2 Display Overview

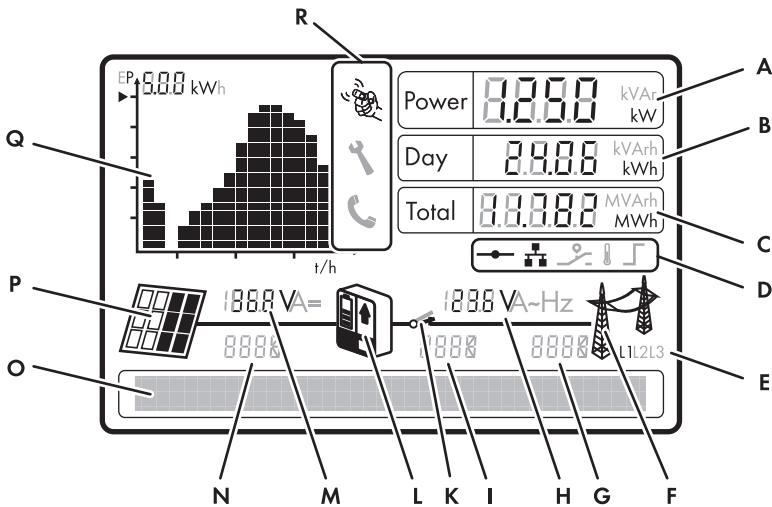















Figure 13: Layout of the display (example)

Position	Symbol	Explanation
A	-	Inverter feed-in power
B	-	Energy fed in during the current day
C	-	Total amount of energy fed in

Position	Symbol	Explanation
D		Active connection to a Speedwire network
		Active connection to Sunny Portal
		Multifunction relay is active
		The operating temperature range of the inverter has been exceeded or the temperature of the Battery Pack is not in the optimum temperature range
		Active power limitation via PV system control
E	-	Line conductor to which the displayed values apply
F		Utility grid
G	-	Event number of an error on the utility grid side
H	-	Output voltage or output current of a line conductor
I	-	Event number of an error in the inverter
K		Grid relay
		If the grid relay is closed, the inverter is feeding into the utility grid. If the grid relay is open, the inverter is disconnected from the utility grid.
L		State of charge of the Battery Pack
		Battery Pack is charged
		Battery Pack is discharged
M	-	Input voltage or input current of a line conductor
N	-	Event number of an error on the PV array side
O	-	Text line to display event and error messages
P		PV array

Position	Symbol	Explanation
Q	-	Diagram with the power curve of the last 16 feed-in hours or the energy yields of the last 16 days <ul style="list-style-type: none"> In order to switch between diagrams, tap once on the enclosure lid.
R		You can operate the display by tapping on the enclosure lid.
		The displayed error must be rectified on-site by a qualified person.
		The displayed error cannot be rectified on-site. <ul style="list-style-type: none"> Contact the SMA Service Line.

9.3 Calling Up Display Messages of the Start-Up Phase

Various inverter information is displayed during the start-up phase that can be called up whenever required during operation.

- Tap on the enclosure lid twice.
- The display alternates between device type, firmware version, serial number or designation of the inverter, IP address, subnet mask, serial number of the Battery Pack, configured country data set and display language.

9.4 Activating and Operating the Display

You can activate and operate the display by tapping on the enclosure lid.

- Activate the display. Tap on the enclosure lid once.
 - The backlight is switched on.
- To move to the next line, tap on the enclosure lid once.
- In order to switch between the power curve of the last 16 feed-in hours and the energy yields of the last 16 days in the diagram, tap on the enclosure lid once.

10 Disconnecting the Inverter from Voltage Sources

⚠ QUALIFIED PERSON

1. Disconnect the circuit breaker and secure it against reconnection.
2. If the multifunction relay is used, switch off any supply voltage to the load.
3. Turn the DC load-break switch towards **OFF** until it snaps into place at position **O**.
4. Wait until all LEDs and the display have gone out.

5. **⚠ DANGER**

Danger to life due to high voltages

The capacitors in the inverter take five minutes to discharge.

- Wait five minutes before opening the enclosure lid.

6. **⚠ CAUTION**

Risk of injury from dropping the enclosure lid

After removing the last screw, the enclosure lid could fall off.

- Remove all screws of the enclosure lid using an Allen key (AF 5). When removing the last screw, support the enclosure lid with one hand. Then remove the enclosure lid by pulling it forwards and make sure that the conical spring washers are retained.

7. Grip behind the left-hand side of the protective cover and lever it loose. Then lift the protective cover forwards and off.

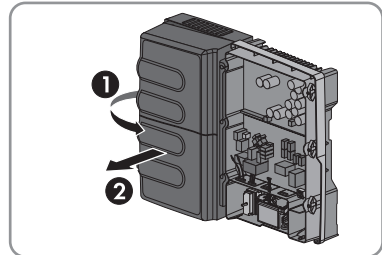

8. Hold the Battery Pack by the side handles, and slide it to the left of the wall mounting bracket up to the stop. This deactivates the lift-off protection of the Battery Pack and gives you more room to pull out the cables.

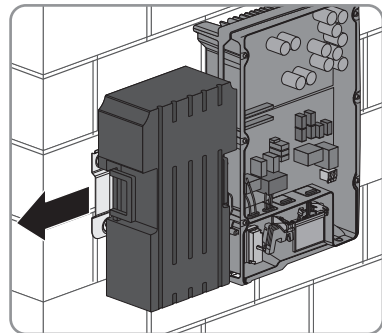

9. Remove the data cable from the Battery Pack.
Press the lateral brackets in and pull the plug out of the pin connector.

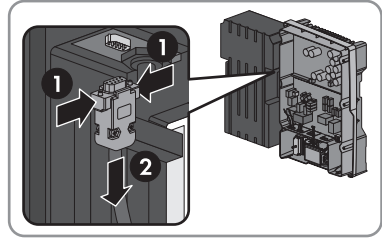

10. Remove the power cable from the Battery Pack.
Turn the mating plug to the left until it releases and pull it out of the pin connector.

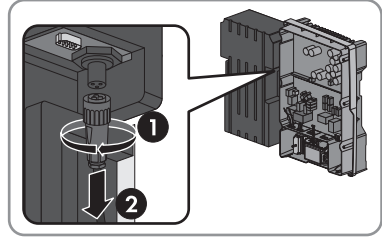

11. If the protective caps of the pin connectors for the data cable and the power cable are available, use them to cover the corresponding pin connectors of the Battery Pack.
12. Insert the data cable and power cable into the bracket on the left-hand side of the inverter.
13. Flip the DC contact protection up and press firmly until it snaps into place.

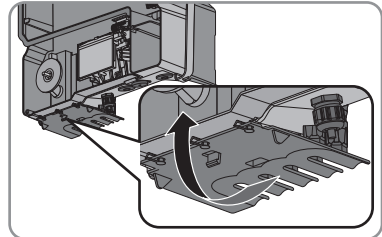

14. Use a current clamp to ensure that no current is present in the DC cables.
15. Release and remove all DC connectors. To do this, insert a flat-blade screwdriver or an angled screwdriver (blade width: 3.5 mm) into one of the side slots and pull the DC connectors straight out. Do not pull on the cable.
16. Ensure that no voltage is present at the DC inputs on the inverter.
17. Ensure that no voltage is present on the AC connecting terminal plate between **L** and **N** using a suitable measuring device. Insert the test probe into each round opening of the terminal.

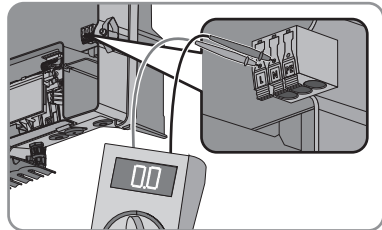

18. Ensure that no voltage is present on the AC connecting terminal plate between **L** and **PE** using a suitable measuring device. Insert the test probe into each round opening of the terminal.

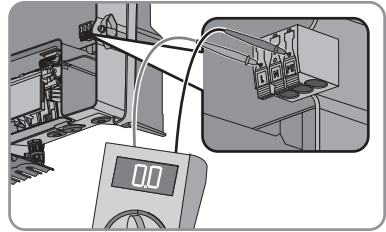

19. If you are using the multifunction relay, ensure that no voltage is present between any of the terminals on the multifunction relay and **PE** on the AC connecting terminal plate.

20. **NOTICE**

Damage to the inverter due to electrostatic discharge

Touching electronic components can cause damage to or destroy the inverter through electrostatic discharge.

- Ground yourself before touching any component.

11 Technical Data

11.1 DC/AC

DC Input

	SB 3600SE-10	SB 5000SE-10
Maximum DC power at $\cos \varphi = 1$	5,200 W	6,600 W
Maximum input voltage	750 V	750 V
MPP voltage range	175 V to 500 V	175 V to 500 V
Rated input voltage	350 V	350 V
Minimum input voltage	125 V	125 V
Initial input voltage	150 V	150 V
Maximum input current, input A	15 A	15 A
Maximum input current, input B	15 A	15 A
Maximum short-circuit current per input*	22.5 A	22.5 A
Maximum reverse current from the inverter into the system for max. 1 ms	1.5 kA	1.5 kA
Number of independent MPP inputs	2	2
Strings per MPP input	2	2

* in accordance with IEC 62109-2: ISC PV

AC Output

	SB 3600SE-10	SB 5000SE-10
Rated power at 230 V, 50 Hz	3,680 W	4,600 W
Maximum apparent AC power	3,680 VA	5,000 VA
Rated grid voltage	230 V	230 V
Nominal AC voltage	220 V, 230 V, 240 V	220 V, 230 V, 240 V
AC voltage range*	180 V to 280 V	180 V to 280 V
Nominal AC current at 220 V	16 A	20.9 A
Nominal AC current at 230 V	16 A	20 A
Nominal AC current at 240 V	15.3 A	19.2 A
Maximum output current	16 A	22 A
Inrush current	0 A	0 A

	SB 3600SE-10	SB 5000SE-10
Total harmonic distortion of the output current with total harmonic distortion of the AC voltage < 2%, and AC power > 50% of the rated power	≤ 4%	≤ 4%
Maximum output current under fault conditions	34 A	34 A
Rated power frequency	50 Hz	50 Hz
AC power frequency*	50 Hz / 60 Hz	50 Hz / 60 Hz
Operating range at AC power frequency 50 Hz	45 Hz to 55 Hz	45 Hz to 55 Hz
Operating range at AC power frequency 60 Hz	55 Hz to 65 Hz	55 Hz to 65 Hz
Power factor at rated power	1	1
Displacement power factor $\cos \varphi$, adjustable	0.8 underexcited to 1 to 0.8 overexcited	0.8 underexcited to 1 to 0.8 overexcited
Feed-in phases	1	1
Connection phases	1	1
Overvoltage category in accordance with IEC 60664-1	III	III

* depending on the configured country data set

Efficiency

	SB 3600SE-10	SB 5000SE-10
Maximum efficiency, η_{\max}	97.1%	97.1%
European efficiency, η_{EU}	96.5%	96.7%

11.2 General Data

Width x height x depth of the inverter with Battery Pack and protective cover	877 mm x 711 mm x 252 mm
Width x height x depth of the inverter	460 mm x 715 mm x 217 mm
Weight of the inverter with Battery Pack and protective cover	59 kg
Weight of the inverter	30 kg
Length x width x height of the inverter packaging	800 mm x 600 mm x 336 mm

Length x width x height of the packaging of the protective cover of the Battery Pack	800 mm x 600 mm x 336 mm
Transport weight of the inverter	38 kg
Transport weight of the protective cover of the battery	4 kg
Climatic category in accordance with IEC 60721-3-3*	3K5
Environmental category	Interior
Pollution degree outside the inverter	3
Pollution degree inside the inverter	2
Operating temperature range	0°C to +40°C
Maximum permissible value for relative humidity, non-condensing	95%
Maximum operating altitude above mean sea level (MSL)	2,000 m
Typical noise emission	≤25 dB(A)
Power loss in night mode	<0.5 W
Maximum data volume per inverter with Speedwire/Webconnect	550 MB/month
Additional data volume when using the Sunny Portal live interface	600 kB/hour
Topology	transformerless
Cooling concept	Convection
Degree of protection in accordance with IEC 60529	IP54
Protection class in accordance with IEC 62103	I
Grid configurations	TN-C, TN-S, TN-C-S, TT (when $V_{N,PE} < 30$ V)
Approvals and national standards As of June 2014**	AS 3100, AS 4777, C10/11:2012, CE, CEI 0-21, DIN EN 62109-1 / IEC 62109-1, DIN EN 62109-2 / IEC 62109-2, EN 50438, G59/3, G83/2, NEN 50438, PPC, PPDS, RD 1699, VDE 0126-1-1, VDE AR-N 4105, VDE-ST-Li-ESS-001:2013/03, VFR 2014

* deviating conditions apply

** **EN 50438:** does not apply to all national appendices of EN 50438.

IEC 62109-2: This standard requires that either the inverter is connected to Sunny Portal and the fault alert is activated in Sunny Portal, or that the multifunction relay in the inverter is retrofitted and used as fault indicator.

11.3 Battery Pack

Continuous power	2 kW
Effective capacity	2 kWh
Rated battery voltage	150 V
Battery voltage range	120 V to 166 V
Maximum charge current	12.5 A
Maximum discharge current	12.5 A
Technology	Lithium-ion polymer
Width x height x depth	634 mm x 350 mm x 190 mm
Weight	27.7 kg
Length x width x height of the packaging	689 mm x 539 mm x 248 mm
Transport weight	34 kg
Climatic category in accordance with IEC 60721-3-4	3K5
Environmental category	Interior
Operating temperature range	0°C to +40°C
Maximum permissible value for relative humidity, non-condensing	95%
Maximum operating altitude above mean sea level (MSL)	2,000 m
Typical noise emission	≤25 dB(A)
Cooling concept	Convection
Degree of protection in accordance with IEC 60529	IP21
Protection class in accordance with IEC 62103	I

11.4 Protective Devices

	SB 3600SE-10	SB 5000SE-10
DC reverse polarity protection	Short-circuit diode	Short-circuit diode
Input-side disconnection point	DC load-break switch	DC load-break switch
DC overvoltage protection	Thermally monitored varistors	Thermally monitored varistors
AC short-circuit current capability	Current control	Current control
Grid monitoring	SMA Grid Guard 3	SMA Grid Guard 3

	SB 3600SE-10	SB 5000SE-10
Maximum permissible fuse protection	32 A	32 A
Ground-fault monitoring	Insulation monitoring: R_{iso} > 400,000 Ω	Insulation monitoring: R_{iso} > 550,000 Ω
All-pole sensitive residual-current monitoring unit	Available	Available

11.5 Climatic Conditions

Installation in accordance with IEC 60721-3-3, Class 3K5

Extended temperature range	0 °C to + 40 °C
Extended humidity range	5% to 95%
Extended air pressure range	79.5 kPa to 106 kPa

Transport in accordance with IEC 60721-3-2, Class 2K3

Temperature range	-30 °C to +45 °C
Relative humidity, non-condensing	5% to 95%

11.6 Equipment

DC connection	SUNCLIX DC connector
AC connection	Spring-cage terminal
Display	LC graphic display
Speedwire/Webconnect	As standard
Multifunction relay	Optional

11.7 Torques

Enclosure lid screws	6 Nm \pm 0.5 Nm
Additional grounding terminal	9 Nm \pm 0.5 Nm
SUNCLIX swivel nut	2.0 Nm

11.8 Data Storage Capacity

Energy yields in the course of the day	63 days
Daily yields	30 years
Event messages for users	250 events
Event messages for installers	250 events

12 Accessories

You will find the accessories for your product in the following overview. If required, these can be ordered from SMA Solar Technology AG or your distributor.

Designation	Brief description	SMA order number
Multifunction relay	Multifunction relay as retrofit kit	MFR01-10
Sunny Home Manager	Sunny Home Manager - wireless PV system monitoring and intelligent energy management	HM-BT-10
Sunny Home Manager incl. SMA radio-controlled sockets	Set consisting of Sunny Home Manager and two SMA radio-controlled sockets	HM-BT-10-SET
SMA Energy Meter	Three-phase, bi-directional metering solution with Speedwire interface for phase-accurate and net (offset) calculation of electricity meter values (limiting current 63A)	EMETER-10

13 Contact

If you have technical problems with our products, contact the SMA Service Line. We need the following information in order to provide you with the necessary assistance:

- Inverter device type
- Inverter serial number
- Inverter firmware version
- Type of the Battery Pack
- Serial number of the Battery Pack
- Manufacturing code of the Battery Pack
- Firmware version of the Battery Pack
- Hardware version of the Battery Pack
- Manufacturing week of the Battery Pack
- Special country-specific settings of the inverter (if applicable)
- Type and number of PV modules connected
- Mounting location and altitude of the inverter
- Three-digit or four-digit event number and display message of the inverter
- Optional equipment, e.g. communication products
- Use of the multifunction relay (if present)

Australia	SMA Australia Pty Ltd. Sydney	Toll free for Australia: 1800 SMA AUS (1800 762 287) International: +61 2 9491 4200
Belgien/Belgique/België	SMA Benelux BVBA/SPRL Mecheln	+32 15 286 730
Brasil	Vide España (Espanha)	
Česko	SMA Central & Eastern Europe s.r.o. Praha	+420 235 010 417
Chile	Ver España	
Danmark	Se Deutschland (Tyskland)	

Deutschland	SMA Solar Technology AG Niestetal	Medium Power Solutions Wechselrichter: +49 561 9522-1499 Kommunikation: +49 561 9522-2499 SMA Online Service Center: www.SMA.de/Service
		Hybrid Energy Solutions Sunny Island: +49 561 9522-399 PV-Diesel Hybridsysteme: +49 561 9522-3199
		Power Plant Solutions Sunny Central: +49 561 9522-299
España	SMA Ibérica Tecnología Solar, S.L.U. Barcelona	Llamada gratuita en España: 900 14 22 22 Internacional: +34 902 14 24 24
France	SMA France S.A.S. Lyon	Medium Power Solutions Onduleurs : +33 472 09 04 40 Communication : +33 472 09 04 41
		Hybrid Energy Solutions Sunny Island : +33 472 09 04 42
		Power Plant Solutions Sunny Central : +33 472 09 04 43
India	SMA Solar India Pvt. Ltd. Mumbai	+91 22 61713888
Italia	SMA Italia S.r.l. Milano	+39 02 8934-7299
Κύπρος/Kıbrıs	Βλέπε Ελλάδα/ Bkz. Ελλάδα (Yunanistan)	
Luxemburg/ Luxembourg	Siehe Belgien Voir Belgique	
Magyarország	lásd Česko (Csehország)	
Nederland	zie Belgien (België)	
Österreich	Siehe Deutschland	
Perú	Ver España	
Polska	Patrz Česko (Czechy)	
Portugal	SMA Solar Technology Portugal, Unipessoal Lda Lisboa	Isto de taxas em Portugal: 800 20 89 87 Internacional: +351 212377860

România	Vezi Česko (Cehia)	
Schweiz	Siehe Deutschland	
Slovensko	pozri Česko (Česká republika)	
South Africa	SMA Solar Technology South Africa Pty Ltd. Centurion (Pretoria)	08600 SUNNY (08600 78669) International: +27 (12) 643 1785
United Kingdom	SMA Solar UK Ltd. Milton Keynes	+44 1908 304899
Ελλάδα	SMA Hellas AE Αθήνα	801 222 9 222 International: +30 212 222 9 222
България	Вижте Ελλάδα (Гърция)	
ไทย	SMA Solar (Thailand) Co., Ltd. กรุงเทพฯ	+66 2 670 6999
대한민국	SMA Technology Korea Co., Ltd. 서울	+82 2 508-8599
+971 2 234-6177	SMA Middle East LLC أبو ظبي	الإمارات العربية المتحدة
Other countries	International SMA Service Line Niestetal	Toll free worldwide: 00800 SMA SERVICE (+800 762 7378423)

14 EC Declaration of Conformity

within the meaning of the EC directives

- 2004/108/EG (Electromagnetic compatibility, EMC)
- 2006/95/EG (Low voltage directive)

SMA Solar Technology AG confirms herewith that the inverters described in this document are in compliance with the fundamental requirements and other relevant provisions of the above-mentioned directives. The entire EC Declaration of Conformity can be found at www.SMA-Solar.com.



SMA Solar Technology

www.SMA-Solar.com

